

BONNER MATHEMATISCHE SCHRIFTEN

Herausgeber:

H. W. ALT, W. BALLMANN, E. BRIESKORN, H. FÖLLMER, J. FREHSE,
U. HAMENSTÄDT, G. HARDER, ST. HILDEBRANDT, F. HIRZEBRUCH,
W. KLINGENBERG, R. LEIS, I. LIEB, H. UNGER, W. VOGEL

Nr. 279

Dimitrios I. Dais

ENUMERATIVE COMBINATORICS OF
INVARIANTS OF CERTAIN COMPLEX
THREEFOLDS WITH TRIVIAL
CANONICAL BUNDLE

Bonn 1995

**ENUMERATIVE COMBINATORICS OF
INVARIANTS OF CERTAIN COMPLEX
THREEFOLDS WITH TRIVIAL
CANONICAL BUNDLE**

Inaugural - Dissertation
zur
Erlangung des Doktorgrades
der
Mathematischen-Naturwissenschaftlichen Fakultät
der
Rheinischen Friedrich-Wilhelms-Universität
zu
Bonn

vorgelegt von

Dimitrios I. Dais

aus Athen/Griechenland

Bonn 1994

Angefertigt mit Genehmigung der
Mathem.-Naturw.-Fakultät

Referent: Prof. Dr. F. Hirzebruch
Koreferent: Prof. Dr. Yu. I. Manin

Tag der Einreichung: 09.01.1994
Tag der ersten mündlichen Prüfung: 06.02.1995
(Prüfer: Prof. Dr. F. Hirzebruch, Prof. Dr. C.-F. Bödigheimer)
Tag der zweiten mündlichen Prüfung: 14.02.1995
(Prüfer: Prof. Dr. B. Korte)

Druck: Rheinische Friedrich-Wilhelm-Universität

ENUMERATIVE COMBINATORICS OF INVARIANTS
OF CERTAIN COMPLEX THREEFOLDS
WITH TRIVIAL CANONICAL BUNDLE

D.I. DAIS

ABSTRACT. Minimal Calabi-Yau models can be roughly classified by studying the behaviour of the linear form being induced by their second Chern class on their nef cone. Strict positivity of $[c_2]_X$ on $\text{Amp}(X)$ leads to CY models X of *general type*. We consider a wide class of such models, namely 3-dimensional well-formed quasismooth complete intersections of hypersurfaces $X = X_{\mathbf{d}} = X_{(d_1, \dots, d_k)}$ in a weighted projective space $\mathbb{P}^{m-1}(\mathbf{w})$ with vanishing amplitude. We give *explicit* formulae for various *invariants* depending on two types of functions in the variables \mathbf{w} and \mathbf{d} . Functions defined by the residues of some symmetric polynomial expressions of \mathbf{w} and \mathbf{d} on the one hand, and enumerating functions of weighted partitions on the other. If X admits non-pathological stratifications, these formulae enable us to determine the delta genus $\Delta(X, \mathbf{L}_X)$ arising from the natural polarization with respect to \mathbf{L}_X and to give a partial generalization of results of Oguiso whenever $\Delta(X, \mathbf{L}_X) \leq 2$. Moreover, we describe the construction and some basic properties of the *toroidal crepant desingularizations* of X 's and compute their invariants by using certain "local-global principles" concerning the combinatorially controllable contributions of the exceptional divisors to the corresponding invariants of the starting point models. Finally, $[c_2]$ -forms, "triple couplings" and "testing bilinear forms" pave the way for the development of a *formal algorithm*, by means of which one can mostly decide if two distinct toroidal crepant desingularizations have definitely different diffeomorphism (resp. homotopy) types or not.

TABLE OF CONTENTS

Introduction	p. 3
Basic notations and definitions	p. 5
1. Calabi-Yau Models	p. 8
2. Complete Intersections in Weighted Projective Spaces	p. 12
3. Toric Crepant Resolutions of 2- and 3-dimensional Gorenstein cyclic Quotient Singularities	p. 37
4. Global Toroidal Crepant Desingularizations	p. 43
5. Intersection Trilinear Forms and $[c_2]$ -Linear Forms	p. 71
6. Topology Change after Flopping	p. 83
7. Appendix: On the Combinatorics concerning the Weighted Partitions and the Counting of Integral Points of a Polyhedron. From Euler's "Partitio Numerorum" to Erhart Polynomials	p. 93
Acknowledgements	p. 107
References	p. 108
List of certain special symbols	p. 113
Index of Terminology	p. 116

Introduction

There are at least two reasons which have made the study of *Calabi-Yau manifolds* so attractive during the last decade. The former is that they represent the high dimensional analogues of $K3$ -surfaces and are naturally expected to inhabit in some very interesting “moduli space landscapes”, both from algebraic geometrical and from differential geometrical point of view. The latter is their pivotal role in the framework of the development of certain *conformal field theories*, like those corresponding to the so called *one-loop semiclassical non-linear sigma models*. (CY manifolds are used as the best candidates for being fibers of the “target spaces” of these sigma models. For an introduction to these themes we refer to the book of Hübsch [65].)

In algebraic geometry, *threefolds with trivial canonical bundle* occupy a very special place within the “3-dimensional cosmography” and one hopes that the methods which will be required for the solution of a number of important open problems regarding period maps, diffeomorphism types, possible bounds of Betti or Hodge numbers, existence and possible “enumeration” of rational curves etc., will considerably promote the whole classification programme of higher dimensional algebraic varieties. For a wonderful survey article written under this perspective, see Friedman [42].

In theoretical physics, on the other hand, where certain *concrete* constructions are needed, a string propagation in a Calabi-Yau background can be expressed geometrically in a convenient way, only in connection with predeterminating Landau-Ginzburg effective Langrangians. By Witten’s generalized “LG/CY-correspondence” [129, § 5], one concludes that the most “favourable” CY manifolds have to be either *hypersurfaces* or *complete intersections* embedded in projective spaces, in weighted projective spaces or products thereof, in general toric varieties or even in Grassmannians.

The case of complete intersections in a product of *usual* projective spaces is discussed in great detail in the above mentioned book of Hübsch [65]. The next CY threefolds coming into question, namely *quasismooth hypersurfaces* in a 4-dimensional weighted projective space (or, more general, in a 4-dimensional Fano toric variety), together with their crepant desingularizations, have been the focal point of many researches during the past few years. Experimental observation at the beginning [15], showing a remarkable “dualism” between the non-trivial Hodge numbers $h^{1,1}$ and $h^{1,2}$ of the desingularized models, turned out later not to be an irony of fate, but the revelation of an exciting *symmetry* with a deep geometrical interpretation and inestimable, up to now, futuristic consequences. For a first mathematical approach to this symmetry the reader is referred to the articles of Roan [102], Morrison [91] and Batyrev [7] and to the collected papers in [131].

However, very little is known for the corresponding *complete intersection case*. In our work we attempt to enlighten that part of *enumerative combinatorics* which is necessary for the description of the invariants and of other important numbers characterizing the desingularized complete intersections in a weighted projective space. Although our results could be valid (with minor modifications) in a more general setting, we prefer to restrict ourselves to weighted projective spaces, as

these lead directly to problems on *linear diophantine equations* or, if you wish, on *linear programming* depending on systems of certain “weights”.

More precisely, the organization of our thesis is as follows. After reviewing some basic facts from Wilson’s classification theory of *minimal CY models* in §1, we explain all the essential details of our construction in §2, give the formulae for the corresponding invariants, and show how the *delta genera distribution* depends on the *denumerants of weighted partitions*. (We should notice that most of the results of §2 are actually *independent* of the dimension and of the amplitude of X ’s, although in the end we focus attention on the CY threefold/model case. For certain interesting new aspects of applications of higher dimensional complete intersections in weighted projective spaces with *negative* amplitude for the realization of some useful, suitably modified (i.e. “non-classical”) Landau-Ginzburg theories, see Schimmrigk [105].)

Using toric geometry in §3, we describe the distinctive features of the T_{N_G} -equivariant crepant resolutions of 2- and 3-dimensional *Gorenstein cyclic quotient singularities* $Z(N_G, \Sigma_0)$, such as the nature of the occurring exceptional prime divisors, their enumeration by their types, their intersection numbers, and the elementary transformation mechanism. Globalizing this resolution process along the components of the singular loci of our X ’s in §4, we define “toroidal” crepant desingularizations and compute their non-trivial Hodge numbers in two different ways. *Intrinsically*, with the step by step recognition of the singularity types, and, when possible, *explicitly* (in terms of w and d) by making use of relative Milnor fibrations, eventually after a rearrangement of the defining polynomials. ($h^{1,1}$ equals obviously the *Picard number* and $h^{1,2}$ “counts” the *moduli number of complex structures*.) At the end of §4 we apply our formulae to a wide class of examples.

Section 5 deals with $[c_2]$ -forms and *intersection trilinear forms* (or, in other words, “topological triple couplings”) of the desingularized models Y . Their evaluations at the members of the canonical \mathbb{Q} -bases of the Picard group of Y are encoded partially in the local informations coming from the data of the “toric triangles” lying over the dissident points of X , and partially in the global geometry of the exceptional divisors and of the pull-back divisor L_Y on Y . These evaluations lend to the various desingularization spaces Y ’s a significant topological characterization, which, in connection with classification results of Wall, Jupp, Žubr and Sullivan, allows us to *distinguish* (in most of the cases) *diffeomorphism* (resp. *homotopy*) types. This method is indicated in §6, where an arithmetical example is examined thoroughly. On the other hand, the formulae of our main theorems of §5 seem to have direct applications to physically important CY threefolds, as they describe the “unquantized” part of the $(1, 1)$ -level *Yukawa couplings*, and they have been already used for computations of some special examples in [64].

Finally, the appendix of §7 is entirely devoted to the *pure combinatorial ingredients* of our formulae, namely to the *pt*-functions which date back to the monumental work of Euler on the “Partitio Numerorum”. Apart from some historical remarks, we manifest here their immediate interpretation as *Ehrhart quasipolynomials* of a dilated special rational convex polyhedron. In addition, in the case where this (or a closely related to it) polyhedron is *integral*, we give formulae which express the *pt*-functions by means of the volumes of appropriate polyhedral faces.

Basic notations and definitions

(i) We denote by $\mathbb{N}, \mathbb{N}_0, \mathbb{Z}, \mathbb{Q}, \mathbb{R}_{\geq 0}, \mathbb{R}$ and \mathbb{C} the set of natural, non-negative integer, integer, rational, non-negative real, real and complex numbers respectively.

(ii) “gcd” and “lcm” are abbreviations for *greater common divisor* and *lower common multiple*.

For $l \in \mathbb{N}$ and $m \in \mathbb{Z}$, we denote by $[m]_l$ the integer which satisfies $0 \leq [m]_l < l$ and $m \equiv [m]_l \pmod{l}$. Furthermore, for $n, k \in \mathbb{N}_0, n \geq k$, we set:

$$\binom{n}{k} := \frac{n^{[k]}}{k!}, \quad \text{where } n^{[k]} := n(n-1) \cdots (n-k+1).$$

(iii) $\mathbb{Z}/(n\mathbb{Z}), n \in \mathbb{N}$, will denote the cyclic group of order n and $\zeta_n := \exp\left(\frac{2\pi\sqrt{-1}}{n}\right)$ the “first” n -th primitive root of unity.

(iv) $|S|$ or $\sharp(S)$ are used to express the number of elements of a finite set S . For $S \subset \mathbb{N}_0$, δ_S denotes the *characteristic function of S* , i.e.

$$\delta_S(s) = \begin{cases} 1, & \text{for } s \in S \\ 0, & \text{otherwise} \end{cases}$$

On the other hand, $\delta_{p,q}$ denotes the usual *Kronecker symbol*.

(v) Let A be a local ring with maximal ideal \mathfrak{M} . A is called *regular* (resp. *normal*) if $\dim(A) = \dim(\mathfrak{M}/\mathfrak{M}^2)$ (resp. if its localizations are integrally closed domains). A sequence $\{a_1, \dots, a_s\}$ of elements of A is called *regular sequence* if $A \neq (a_1, \dots, a_s)A$ and if for all $i \in \{0, \dots, s-1\}$, a_{i+1} is not a zero divisor in $A/(a_1, \dots, a_i)A$. The *depth* of A is defined to be the maximum of the lengths of regular sequences $\{a_1, \dots, a_s\}$ with $a_i \in \mathfrak{M}, \forall i, 1 \leq i \leq s$. A is called *Cohen-Macaulay* if $\dim(A) = \text{depth}(A)$. If A is Cohen-Macaulay, then A is called *Gorenstein* whenever $\text{Ext}_A^{\dim(A)}(A/\mathfrak{M}, A) \cong A/\mathfrak{M}$.

(vi) In section 2 we shall consider certain graded commutative rings $A = \bigoplus_{d \geq 0} A_d$ with $A_0 = \mathbb{C}$ the field of complex numbers and A finitely generated as \mathbb{C} -algebra. We denote by $\mathfrak{M} := A_+ := \bigoplus_{d > 0} A_d$ the unique maximal ideal of such a ring A . A *graded A -module* is an A -module M , together with a decomposition $M = \bigoplus_{d \in \mathbb{Z}} M_d$ such that $A_d \cdot M_e \subset M_{d+e}$. For any graded A -module M , and for any $n \in \mathbb{Z}$, we define the *twisted module $M(n)$* by shifting n places to the left, i.e. $M(n)_d = M_{d+n}$.

(vii) For $q \in \mathbb{N}_0$, let Ext_A^q denote the derived functors of Hom_A within the category $\mathcal{GM}(A)$ of graded A -modules. $H_{\mathfrak{M}}^q : \mathcal{GM}(A) \rightarrow \mathcal{GM}(A)$ is defined to be the functor which sends a graded A -module M to the q -th *algebraic local cohomology group*

$$H_{\mathfrak{M}}^q(M) := \varinjlim_l \text{Ext}_A^q(A/\mathfrak{M}^l, M)$$

of M supported at \mathfrak{M} (cf. [55], [56]).

(viii) Let A be a graded ring and M a graded A -module as in (vi).

$$X = \text{Proj}(A) := \{\mathfrak{p} \in \text{Spec}(A) \mid \mathfrak{p} \text{ homogeneous and } \mathfrak{p} \not\subseteq A_+\}$$

will denote, as usual, the projective scheme associated to A , \tilde{M} the \mathcal{O}_X -module sheaf associated to M on X , $\mathcal{O}_X(n) := A(n)^\sim, n \in \mathbb{Z}, M(n)^\sim$ the twisted sheaf

associated to $M(n)$ and $\tilde{M}(n) := \tilde{M} \otimes_{\mathcal{O}_X} \mathcal{O}_X(n)$ (cf. [53, Ch. II, §2.5 - §2.6.] or [61, Ch. II, §5]). Note that, if A is generated as a \mathbb{C} -algebra by A_1 , then $M(n) \sim \cong \tilde{M}(n)$, but in general this is not true.

(ix) The *Poincaré-series* of a \mathbb{Z} -graded vector space $A = \bigoplus_{\nu \in \mathbb{Z}} A_\nu$ with finite-dimensional homogeneous components is defined as the formal Laurent series

$$\mathcal{P}(A; x) := \sum_{\nu \in \mathbb{Z}} (\dim A_\nu) x^\nu$$

Correspondingly, the *Poincaré series* of a projective scheme X is the formal series

$$\mathcal{P}(X; x) := \sum_{n \in \mathbb{Z}} (\dim(H^0(X, \mathcal{O}_X(n)))) x^n$$

(x) Let A be again a graded \mathbb{C} -algebra. $\Omega_A^1 := \Omega_{A/\mathbb{C}}^1$ denotes the A -module of *Kähler \mathbb{C} -differentials* of A and $\Omega_A^p := \wedge^p \Omega_A^1$, $\forall p, p \in \mathbb{N}_0$. Furthermore, if for a homogeneous $h \in A_+$, $A_{(h)}$ is the subring of elements of degree 0 in the localized ring A_h , then $\{\text{Spec}(A_{(h)}) | h \text{ homogeneous element of } A_+\}$ is a basis of $X = \text{Proj}(A)$ and the \mathcal{O}_X -module sheaf of germs of p -forms Ω_X^p can be defined by globalization, so that

$$\Omega_X^p |_{\text{Spec}(A_{(h)})} \cong \Omega_{\text{Spec}(A_{(h)})}^p \cong (\Omega_{A_{(h)}}^p)^\sim.$$

(By $(\Omega_X^p)^\vee := \mathcal{H}om_{\mathcal{O}_X}(\Omega_X^p, \mathcal{O}_X)$ and $(\Omega_X^p)^{\vee\vee}$ we shall denote the *dual* and the *bidual* of the sheaf of p -forms on X respectively.)

(xi) By a *complex variety* we mean an integral, separated algebraic scheme over \mathbb{C} . A complex variety is *complete* if its structural morphism to $\text{Spec}(\mathbb{C})$ is proper. If X is a complex variety, then a point $x \in X$ (resp. the whole space X) will be called *regular*, *normal*, *Cohen-Macaulay* or *Gorenstein* if the local ring $\mathcal{O}_{X,x}$ (resp. all local rings $\mathcal{O}_{X,x}$, $\forall x \in X$) is (resp. are) of this type. In particular, we set

$$\text{Reg}(X) := \{x \in X : \mathcal{O}_{X,x} \text{ regular}\} \quad \text{and} \quad \text{Sing}(X) := X \setminus \text{Reg}(X)$$

for the *regular* and the *singular locus* of X respectively. A (closed) *subvariety* Y of X is a closed integral subscheme of X . A subvariety Y of X with $\text{codim}_X(Y) = 1$ is especially called a *prime divisor* of X . A *Weil divisor* is an element of the free abelian group which is generated by the prime divisors of X .

(xii) Let X be a *normal* r -dimensional complex variety. If D is a Weil divisor of X , let $\mathcal{O}_X(D)$ denote the corresponding divisorial sheaf (cf. [98, App. to §1]). D is called *Cartier divisor* if $\mathcal{O}_X(D)$ is invertible. For r Cartier divisors D_1, \dots, D_r , for which $W := \bigcap_{i=1}^r \text{supp}(D_i)$ is *complete*, one defines their *intersection number* as $(D_1 \cdot D_2 \cdots D_r) := \deg_W(D_1 \cdots D_r) \in \mathbb{Z}$ (see e.g. [46, Ch. 2]). Moreover, if $j : \text{Reg}(X) \hookrightarrow X$ is the natural inclusion of the regular locus of X into X , we define $\tilde{\Omega}_X^\bullet := j_*(\Omega_{\text{Reg}(X)}^\bullet) = j_*(j^*\Omega_X^\bullet)$. $\omega_X := \tilde{\Omega}_X^r$ is called the *canonical* or *dualizing sheaf* of X . Note that: X is Gorenstein $\iff X$ is Cohen-Macaulay and ω_X is invertible. On the other hand, we define $\tilde{\Omega}_X^\bullet := \pi_*\Omega_Y^\bullet$, where $\pi : Y \rightarrow X$ is an arbitrary desingularization of X . We have an inclusion $\tilde{\Omega}_X^p \hookrightarrow \tilde{\Omega}_X^p$, and X has at

most *rational singularities* $\iff X$ is Cohen-Macaulay and $\bar{\Omega}_X^\bullet \cong \tilde{\Omega}_X^\bullet$.

(xiii) A complex variety is called *V-variety* (or rather *Q-variety*) if it has at most *quotient singularities*. If X is a projective *V-variety*, then

$$\bar{\Omega}_X^\bullet \cong \tilde{\Omega}_X^\bullet \cong (\Omega_X^\bullet)^{\vee\vee}$$

because any quotient singularity is rational and X is normal.

(xiv) For a complex variety X of dimension r , we denote by $b_i(X) := \dim_{\mathbb{Q}} H^i(X, \mathbb{Q})$, $0 \leq i \leq 2r$, $e(X) := \sum_{i=0}^{2r} (-1)^i b_i(X)$, $h^i(X, \mathcal{F}) := \dim_{\mathbb{C}} H^i(X, \mathcal{F})$, $\chi(X, \mathcal{F}) := \sum_{i=0}^{\infty} (-1)^i h^i(X, \mathcal{F})$, the i -th Betti number of X , the topological Euler-Poincaré characteristic of X , the dimension of the i -th cohomology group of a coherent sheaf \mathcal{F} over X and the corresponding Euler-Poincaré characteristic of \mathcal{F} over X respectively. $\text{Pic}(X)$ will denote the *Picard group* of X , i.e. the group of isomorphism classes of invertible sheaves (or line bundles) over X . (Line bundles will be identified with linear equivalence classes of Cartier divisors.)

(xv) A pair (X, \mathbf{L}) consisting of a normal complete complex variety and an ample (resp. nef and big) bundle \mathbf{L} over X is called a *polarized* (resp. *quasi-polarized*) *variety*. Fujita's *delta genus* of an r -dimensional polarized variety (X, \mathbf{L}) is defined by

$$\Delta(X, \mathbf{L}) := r + \mathbf{L}^r - h^0(X, \mathbf{L})$$

and turns out to be a very powerful invariant of (X, \mathbf{L}) as it leads to a partial (or, sometimes, complete) classification of such pairs, when it takes values which are small enough. (For an introduction to the corresponding classification theories and adjunction techniques we refer to Fujita's monograph [45].)



§ 1. Calabi-Yau models

This section is introductory and serves as a reminder of certain fundamental properties of CY threefolds and of their singular analogues.

Definition 1.1. By a *Calabi-Yau threefold* (*CY threefold*) we mean 3-dimensional complete, projective, smooth complex variety Y with trivial canonical class and $h^1(Y, \mathcal{O}_Y) = 0$. (Note that $h^2(Y, \mathcal{O}_Y) = h^{2,0}(Y) = 0$ by Serre and Hodge duality).

Thanks to Yau's verification of Calabi's conjecture [130], the representative of any such threefold Y in the analytic category admits a Ricci-flat metric. The topological Euler-Poincaré characteristic of Y is given by

$$(1.1) \quad e(Y) = 2(h^{1,1}(Y) - h^{1,2}(Y)) = 2(b_2(Y) + 1) - b_3(Y)$$

From the exponential cohomology sequence we get $\text{Pic}(Y) \cong H^2(Y, \mathbb{Z})$ and $\rho(Y) = h^{1,1}(Y) = b_2(Y)$, where $\rho(Y)$ denotes the *Picard number* of Y . On the other hand, the second non-trivial Hodge number $h^{1,2}(Y)$ of Y expresses the number of parameters for the complex structure on Y in the following sense:

Theorem 1.2. (*Bogomolov [12], Tian [118], Todorov [119]*) *The first order deformations of a CY threefold Y are unobstructed, and the corresponding local moduli space of Y is smooth and has dimension $h^{1,2}(Y) = h^1(Y, \Theta_Y)$.*

Moreover, general structure theorems, due to Beauville, Bogomolov, Kobayashi and Michelson, inform us that a CY threefold Y has finite fundamental group unless some finite unramified covering of it is either an abelian threefold or is decomposable into a product of a K-3 surface with an elliptic curve (see [8], [9]). Up to these two cases, in which $e(Y) = 0$, Y has the whole $SU(3)$ as holonomy group.

Definition 1.3. Let Y be a complete, smooth (but not necessarily projective) complex threefold with $h^1(Y, \mathcal{O}_Y) = h^2(Y, \mathcal{O}_Y) = 0$ and trivial canonical class. We define:

$$\begin{aligned} [c_2]_Y : \text{Pic}(Y) \ni \mathcal{O}_Y(D) &\longmapsto (c_2(Y) \smile c_1(\mathcal{O}_Y(D)))[Y] \in \mathbb{Z}, \\ q_Y : (\text{Pic}(Y))^3 \ni (\mathcal{O}_Y(D_1), \mathcal{O}_Y(D_2), \mathcal{O}_Y(D_3)) &\longmapsto (D_1 \cdot D_2 \cdot D_3) = \\ &(c_1(\mathcal{O}_Y(D_1)) \smile c_1(\mathcal{O}_Y(D_2)) \smile c_1(\mathcal{O}_Y(D_3)))[Y] \in \mathbb{Z} \end{aligned}$$

the linear form on $\text{Pic}(Y)$ induced by the second Chern class of Y and the trilinear symmetric form induced by intersection numbers respectively. In the physics literature, in the case in which Y is a CY threefold, the latter is usually called *the unquantized topological Yukawa coupling form*. (Remark: We shall use the notations $[c_2]_Y^{\mathbb{Q}}$ and $q_Y^{\mathbb{Q}}$ (resp. $[c_2]_Y^{\mathbb{R}}$ and $q_Y^{\mathbb{R}}$) if we work with $\text{Pic}_{\mathbb{Q}}(Y) := \text{Pic}(Y) \otimes_{\mathbb{Z}} \mathbb{Q}$ (resp. $\text{Pic}_{\mathbb{R}}(Y)$) instead of $\text{Pic}(Y)$.)

As it is known from the classification theory of simply connected, compact, oriented, 6-dimensional C^∞ -differentiable manifolds with vanishing second Stiefel-Whitney class, developed by Wall [122], Žubr [132] and Sullivan [114], the oriented diffeomorphism type of simply connected complex threefolds Y satisfying the properties of 1.3. is determined, up to finite possibilities, by means of the quadruple $(H^2(Y, \mathbb{Z}), b_3(Y), -2[c_2]_Y, q_Y)$. In particular, if $H^3(Y, \mathbb{Z})$ is assumed to be torsion-free, this quadruple classifies Y (up to a diffeomorphism) uniquely. (For analogous classification theorems up to an orientation-preserving homotopy equivalence or up to a homeomorphism, see Jupp [68] and Žubr [132], [133].)

Unfortunately, these theorems cannot be applied directly in concrete examples, because

- (i) there is no satisfactory way to check whether two symmetric trilinear forms are equivalent up to change of basis or not,
- (ii) it is often very difficult to find explicit integer bases of $H^2(Y, \mathbb{Z})$, and
- (iii) there is not always adequate information available about the torsion part of $H^3(Y, \mathbb{Z})$.

In practice, one tries to develop methods to distinguish, if possible, diffeomorphism (resp. homotopy) types, just by keeping necessary conditions of the above theorems and by introducing further controllable numerical invariants, which could hopefully be different for the regarded threefolds. Motivated by similar considerations of Green and Hübsch ([49, p. 314], [65, p. 174]), we give the following definition:

Definition 1.4. Let Y be a complex threefold as in 1.3. We define

$$\begin{aligned} \varphi_Y : (\text{Pic}(Y))^4 \ni (\mathcal{O}_Y(D_1), \mathcal{O}_Y(D_2), \mathcal{O}_Y(D_3), \mathcal{O}_Y(D_4)) \mapsto \\ (q_Y(\mathcal{O}_Y(D_1), \mathcal{O}_Y(D_2), \mathcal{O}_Y(D_3)) \cdot [c_2]_Y(D_4) + \text{cyclic permutations}) \in \mathbb{Z} \end{aligned}$$

φ_Y is a symmetric quadrilinear form, which induces a bilinear form:

$$(1.2) \quad \beta_Y : (\text{Sym}^2(\text{Pic}(Y)))^2 \rightarrow \mathbb{Z}$$

(We just define the image of a pair of decomposable elements of $\text{Sym}^2(\text{Pic}(Y))$ under β_Y to be the evaluation of φ_Y at its members and we extend linearly.) β_Y will be called *the testing bilinear form* of Y .

The negation direction of the statement of the next lemma will be very useful.

Lemma 1.5. Let Y_1, Y_2 be two simply connected complex threefolds satisfying the properties mentioned in 1.3. A necessary condition, under which Y_1 and Y_2 have the same oriented diffeomorphism (resp. homotopy) type, is the equality of their Betti numbers and the existence of an isomorphism $f : H^2(Y_1, \mathbb{Q}) \xrightarrow{\cong} H^2(Y_2, \mathbb{Q})$, such that $[c_2]_{Y_1}^{\mathbb{Q}}(\cdot) = [c_2]_{Y_2}^{\mathbb{Q}}(f(\cdot))$ and $q_{Y_1}^{\mathbb{Q}}(\cdot, \cdot, \cdot) = q_{Y_2}^{\mathbb{Q}}(f(\cdot), f(\cdot), f(\cdot))$.

In particular, in this case, $\beta_{Y_i}^{\mathbb{Q}}$ (resp. $\beta_{Y_i}^{\mathbb{R}}$), $i = 1, 2$, will be equivalent as \mathbb{Q} - (resp. \mathbb{R} -) bilinear forms.

Proof. If Y_1 and Y_2 have the same oriented diffeomorphism (resp. homotopy) type, then their fundamental classes are isomorphic and it is evident that $q_{Y_1}^{\mathbb{Q}}(\cdot, \cdot, \cdot) =$

$q_{Y_2}^{\mathbb{Q}}(f(\cdot), f(\cdot), f(\cdot))$. Since $-2c_2^{\mathbb{Q}}$ equals the first rational Pontrjagin class, the equality $[c_2]_{Y_1}^{\mathbb{Q}}(\cdot) = [c_2]_{Y_2}^{\mathbb{Q}}(f(\cdot))$ follows from the *topological* invariance of the rational Pontrjagin classes (which is due to Novikov) and the *homotopic* invariance of a remarkable class introduced by Žubr [132], [133], which turns into the first Pontrjagin class after multiplication by 4. \square

We shall come back to it with an example in section 6.

Let us now turn our attention to the singular models.

Definition 1.6. ([126], [127]) A complete, projective, normal 3-dimensional complex variety X with trivial dualizing sheaf and $h^1(X, \mathcal{O}_X) = h^2(X, \mathcal{O}_X) = 0$ is called *CY model* if it has at most rational Gorenstein singularities (i.e. canonical singularities of index 1 in Reid's terminology [98], [99]) and if there is a (necessarily crepant) desingularization $\pi : Y \rightarrow X$ of X with Y a CY threefold. A *CY contraction* of a CY model X_1 is defined to be a birational morphism $f : X_1 \rightarrow X_2$ to another CY model X_2 , such that $\rho(X_2) < \rho(X_1)$. A CY model is called *minimal* if it does not admit any CY contraction.

Definition 1.7. Let X be a CY model and $\pi : Y \rightarrow X$ a crepant desingularization of X . We define the linear form $[c_2]_X : \text{Pic}(X) \rightarrow \mathbb{Z}$ by $[c_2]_X(\mathcal{O}_X(D)) := [c_2]_Y(\pi^*\mathcal{O}_X(D))$, for all Cartier divisors D on X . (Note that $[c_2]_X$ is essentially independent of the concrete choice of π .)

If we now denote by $\text{Amp}(X)$ the *ample cone* of X in $\text{Pic}_{\mathbb{R}}(X)$, generated by the real classes of ample Cartier divisors, its closure $\overline{\text{Amp}(X)}$ parametrizes the real classes of nef Cartier divisors and is dual to *Mori's cone* $\overline{\text{NE}}(X)$ consisting of the real classes of effective 1-cycles. We call $\overline{\text{Amp}(X)}$ the *nef cone* of X . By a result of Miyaoka [87, thm. 6.6., p. 468] we deduce:

Theorem 1.8. *The linear form $[c_2]_X^{\mathbb{R}}$, which is associated to a CY model X , takes non-negative values on the nef cone $\overline{\text{Amp}(X)} \subset \text{Pic}_{\mathbb{R}}(X)$ of X .*

Various properties of the nef cone $\overline{\text{Amp}(X)}$ of CY models X have been studied extensively by Wilson [126], [127], [128], who proposed to use $[c_2]_X^{\mathbb{R}}$ in a role parallel to the one played by the canonical divisor in the classification theory of compact complex surfaces, in order to achieve a first type separation for X 's. Wilson's rough classification of *minimal* CY models is outlined in the following table:

	Behaviour of $[c_2]_X^{\mathbb{R}}$ on $\overline{\text{Amp}(X)}$	Type of X
(a)	$[c_2]_X^{\mathbb{R}}$ is trivial on $\overline{\text{Amp}(X)}$	abelian quotient type
(b)	non-trivial but not strictly positive	fibering type (?)
(c)	strictly positive on $\overline{\text{Amp}(X)}$	general type

Shepherd-Barron and Wilson [107] proved that the threefolds (a) can always be represented as quotients of abelian threefolds by (not necessarily freely acting)

finite groups. Wilson [128] investigated certain models belonging to case (b) and conjectured the existence of fiber space structure for any such X . In fact, cases (a) and (b) include minimal CY models of “special type” and there should be a complete “fine” classification for them, (*) whereas (c) constitutes the “general case” in which, analogously to the surfaces of general type, there are still a lot of open questions arising from “geographical problems”. For instance, a minimal CY model of general type X is equipped with a canonical polarization coming from c_2 in a natural way. If L is an ample line bundle on X and $\Delta(X, L)$ the corresponding delta genus, what kind of lattice regions should be expected to be covered by its values? In which regions do L^3 and $[c_2]_X(L)$ reside? Finally, if $\Delta(X, L) \geq 3$, what kind of relationships are there between them (and eventually the topological invariants of X) besides the standard RR-inequality $[c_2]_X(L) \leq 10 L^3$? (Is it possible to get any absolute or relative new bounds?)

In this thesis we construct minimal CY models of general type by considering certain quasismooth complete intersections X in a weighted projective space with vanishing amplitude. Especially, we emphasize the combinatorial complexity of the above mentioned numbers, and we study the forms q_Y and $[c_2]_Y$ of some natural crepant desingularizations Y of X in detail.



(*) K. Oguiso has meanwhile classified the CY models of type (a) (see K. Oguiso: “On the complete classification of Calabi-Yau threefolds of type III_0 ”, Ochanomizu University, Preprint, December 1994). His main theorem says that, up to isomorphism, there are only two different CY models of this kind, both of which are rigid. Namely, the spaces coming from the crepant resolution of the 27 quotient singularities of A_3/G and of the 7 quotient singularities of A_7/G' respectively. Here A_3 denotes the triple cartesian product $(E_{\zeta_3})^3$ of the elliptic curve $E_{\zeta_3} := \mathbb{C}/(\mathbb{Z} \oplus \mathbb{Z}\zeta_3)$, $A_7 := H^0(C, \Omega_C^1)^\vee / H_1(C, \mathbb{Z})$ the Jacobian variety of the Kleinian quartic curve $C := \{[x_1, x_2, x_3] \in \mathbb{P}^2 \mid x_1x_2^3 + x_2x_3^3 + x_3x_1^3 = 0\}$, and G (resp. G') the cyclic automorphism group of order 3 (resp. of order 7) generated by the multiplication $(z_1, z_2, z_3) \mapsto (\zeta_3 z_1, \zeta_3 z_2, \zeta_3 z_3)$ (resp. by the multiplication $[x_1, x_2, x_3] \mapsto [x_1, \zeta_7 x_2, \zeta_7^2 x_3]$).

§ 2. Complete intersections in weighted projective spaces

In this section we recall briefly some basic facts from the theory of complete intersections in a weighted projective space, we prove a Lefschetz-type theorem for dimensions ≥ 3 and we give combinatorial formulae which enable the determination of all the interesting invariants and of the delta genera. For an introduction to the theory of weighted projective spaces, the reader is referred to the expository articles of Delorme [28], Dolgachev [32] and Beltrametti-Robbiano [10].

Definition 2.1. For $m \in \mathbb{N}$, let $\mathbb{P}^{m-1} = \mathbb{P}^{m-1}(\mathbf{1})$ denote the usual complex $(m-1)$ -dimensional projective space. If $\mathbf{w} = (w_1, \dots, w_m) \in \mathbb{N}^m$, we define $S(\mathbf{w})$ to be the polynomial algebra $\mathbb{C}[z_1, \dots, z_m]$ over \mathbb{C} , graded by the condition $\deg(z_i) = w_i, \forall i, 1 \leq i \leq m$. The $(m-1)$ -dimensional *weighted projective space* (*w.p.s.*) $\mathbb{P}^{m-1}(\mathbf{w})$ is defined as the irreducible normal projective variety

$$\mathbb{P}^{m-1}(\mathbf{w}) := \text{Proj}(S(\mathbf{w})).$$

$\mathbb{P}^{m-1}(\mathbf{w})$ is isomorphic to $\mathbb{P}^{m-1} / \prod_{i=1}^m (\mathbb{Z}/w_i\mathbb{Z})$, and the canonical projection

$$p(\mathbf{w}) : \mathbb{P}^{m-1} \longrightarrow \mathbb{P}^{m-1}(\mathbf{w})$$

corresponds to the canonical ramified covering:

$$[x_1, \dots, x_m] \mapsto [z_1, \dots, z_m], \quad z_i := x_i^{w_i}, \quad \forall i, \quad 1 \leq i \leq m,$$

with Galois group $\prod_{i=1}^m (\mathbb{Z}/w_i\mathbb{Z})$. Equivalently, one defines $\mathbb{P}^{m-1}(\mathbf{w})$ as the geometric quotient $(\mathbb{C}^m \setminus \{0\})/\mathbb{C}^*$, where \mathbb{C}^* acts by:

$$\mathbb{C}^* \times (\mathbb{C}^m \setminus \{0\}) \ni (t, (z_1, \dots, z_m)) \longmapsto (t^{w_1} z_1, \dots, t^{w_m} z_m) \in (\mathbb{C}^m \setminus \{0\}).$$

Its associated projection map will be denoted by

$$\pi(\mathbf{w}) : (\mathbb{C}^m \setminus \{0\}) \longrightarrow \mathbb{P}^{m-1}(\mathbf{w}).$$

We shall say that \mathbf{w} is *reduced* (resp. *normalized*) if $\gcd(w_1, \dots, w_m) = 1$ (resp. if $\gcd(w_1, \dots, \hat{w}_i, \dots, w_m) = 1, \forall i, 1 \leq i \leq m$). $\mathbb{P}^{m-1}(\mathbf{w})$ is called *well-formed* if \mathbf{w} is normalized.

Definition 2.2. For $m \in \mathbb{N}$ and $\mathbf{w} = (w_1, \dots, w_m) \in \mathbb{N}^m$ an arbitrary m -tuple of weights, we define

$$\bar{w}_i := \frac{w_i}{\gcd(w_1, \dots, w_m)},$$

$$\rho_i(\mathbf{w}) := \gcd(\bar{w}_1, \dots, \widehat{\bar{w}_i}, \dots, \bar{w}_m),$$

and

$$w'_i := \frac{\bar{w}_i}{\text{lcm}(\rho_1(\mathbf{w}), \dots, \overbrace{\rho_i(\mathbf{w})}^{\bar{w}_i}, \dots, \rho_m(\mathbf{w}))} \quad \text{for all } i, \quad 1 \leq i \leq m.$$

$\bar{\mathbf{w}} := (\bar{w}_1, \dots, \bar{w}_m)$ (resp. $\mathbf{w}' := (w'_1, \dots, w'_m)$) will be called the *reduction* (resp. *the normalization*) of \mathbf{w} .

Proposition 2.3. ([10,3.A.3, 3.C.5]) *There exist natural isomorphisms:*

$$\mathbb{P}^{m-1}(\mathbf{w}) \cong \mathbb{P}^{m-1}(\bar{\mathbf{w}}) \cong \mathbb{P}^{m-1}(\mathbf{w}')$$

Remark 2.4. In contrast to the case of a usual projective space, the twisted sheaves $\mathcal{O}_{\mathbb{P}^{m-1}(\mathbf{w})}(n) = S(\mathbf{w})(n)^\sim$ on a weighted projective space $\mathbb{P}^{m-1}(\mathbf{w})$ are, in general, not so “well-behaved”. For instance:

- (a) It may happen that $\mathcal{O}_{\mathbb{P}^{m-1}(\mathbf{w})}(n_1) \cong \mathcal{O}_{\mathbb{P}^{m-1}(\mathbf{w})}(n_2)$ with $n_1 \neq n_2$.
- (b) Even if $\mathbf{w} = \mathbf{w}'$, $\mathcal{O}_{\mathbb{P}^{m-1}(\mathbf{w})}(n)$ is not always invertible.
- (c) A sheaf $\mathcal{O}_{\mathbb{P}^{m-1}(\mathbf{w})}(n)$, $n > 0$, could be invertible but not ample if $\mathbf{w} \neq \mathbf{w}'$.
- (d) The canonical homomorphism

$$\mathcal{O}_{\mathbb{P}^{m-1}(\mathbf{w})}(n_1) \otimes \mathcal{O}_{\mathbb{P}^{m-1}(\mathbf{w})}(n_2) \rightarrow \mathcal{O}_{\mathbb{P}^{m-1}(\mathbf{w})}(n_1 + n_2)$$

induced by the natural multiplication

$$S(\mathbf{w})(n_1) \otimes S(\mathbf{w})(n_2) \rightarrow S(\mathbf{w})(n_1 + n_2)$$

may be not an isomorphism.

For counterexamples and further discussion see [32, § 1.5] and [10, 3D]. The pathologies of this kind are mainly due to the number theoretical relations between the weights and to the existence of singularities on $\mathbb{P}^{m-1}(\mathbf{w})$. Mori [90] studied the largest open subset, for which most of the nice properties of the twisted sheaves, which are valid for unweighted spaces, can be preserved unchanged. Finally, Dimca and Dimiev [31] proved that this open set is nothing but the regular locus $\text{Reg}(\mathbb{P}^{m-1}(\mathbf{w}))$ of $\mathbb{P}^{m-1}(\mathbf{w})$.

Theorem 2.5. ([31]) $\mathbb{P}^{m-1}(\mathbf{w})$ is a V -variety with only cyclic quotient singularities, and its singular locus can be written as a union

$$\text{Sing}(\mathbb{P}^{m-1}(\mathbf{w})) = \bigcup_{I \subset \{1, 2, \dots, m\}} \{\mathbb{P}_I(\mathbf{w}) \mid c(\mathbf{w}, I) > 1\},$$

where

$$\mathbb{P}_I(\mathbf{w}) := \mathbb{P}_I := \mathbb{P}^{m-1}(\mathbf{w}) \cap \{z_i = 0, \forall i \in I\}$$

and

$$c(\mathbf{w}, I) := c_I := \gcd(w_j \mid j \in \{1, \dots, m\} \setminus I).$$

Definition 2.6. Let $\mathbf{w} \in \mathbb{N}^m$ be an m -tuple of weights, $\bar{\mathbf{w}}$ its reduction, \mathbf{w}' its normalization and $\rho_i(\mathbf{w}), 1 \leq i \leq m$, defined as in 2.2. Since $\gcd(\bar{w}_i, \rho_i(\mathbf{w})) = 1$, there exist two unique integers $\gamma_i(n; \mathbf{w})$ and $\varepsilon_i(n; \mathbf{w})$ with

$$n = \gamma_i(n; \mathbf{w})\bar{w}_i + \varepsilon_i(n; \mathbf{w})\rho_i(\mathbf{w}), \quad 0 \leq \gamma_i(n; \mathbf{w}) < \rho_i(\mathbf{w}) \quad \text{for all } i, \quad 1 \leq i \leq m,$$

and for all $n \in \mathbb{Z}$. We define

$$(2.1) \quad \theta(n; \mathbf{w}) := \frac{n - \sum_{i=1}^m \bar{w}_i \gamma_i(n; \mathbf{w})}{\text{lcm}(\rho_1(\mathbf{w}), \dots, \rho_m(\mathbf{w}))}$$

It is easy to see that $\theta(n; \mathbf{w}) \in \mathbb{Z}$, for all $n \in \mathbb{Z}$.

Proposition 2.7. ([10, 3.C.1, 3.C.7.]) For all $n \in \mathbb{Z}$, we have:

$$\mathcal{O}_{\mathbb{P}^{m-1}(\mathbf{w})}(\gcd(w_1, \dots, w_m) \cdot n) \cong \mathcal{O}_{\mathbb{P}^{m-1}(\bar{\mathbf{w}})}(n) \cong \mathcal{O}_{\mathbb{P}^{m-1}(\mathbf{w}')}(\theta(n; \mathbf{w}))$$

Proposition 2.8. ([10, 4.B.7], [104, Th.2.7]) Let $m \in \mathbb{N}$, $\mathbf{w} \in \mathbb{N}^m$ and $\mathbb{P}^{m-1}(\mathbf{w})$ be the corresponding w.p.s. Then:

- (i) $\mathcal{O}_{\mathbb{P}^{m-1}(\mathbf{w})}(n)$ is coherent and Cohen-Macaulay, for all $n \in \mathbb{Z}$.
- (ii) The sheaf $\mathcal{O}_{\mathbb{P}^{m-1}(\mathbf{w})}(\text{lcm}(w_1, \dots, w_m))$ is ample.
- (iii) In the case, in which $\mathbf{w} = \mathbf{w}'$, $\text{Pic}(\mathbb{P}^{m-1}(\mathbf{w}))$ is generated by the class $[\mathcal{O}_{\mathbb{P}^{m-1}(\mathbf{w})}(\text{lcm}(w_1, \dots, w_m))]$.

For general ampleness criteria of twisted sheaves, see [28, § 2] or [10, § 4 B].

Proposition 2.9. ([32, § 1.4]) A w.p.s. $\mathbb{P}^{m-1}(\mathbf{w})$ has the following properties:

- (i) The Serre homomorphism $S(\mathbf{w}) \rightarrow \bigoplus_{n \geq 0} H^0(\mathbb{P}^{m-1}(\mathbf{w}), \mathcal{O}_{\mathbb{P}^{m-1}(\mathbf{w})}(n))$ is a graded isomorphism.
- (ii) $H^s(\mathbb{P}^{m-1}(\mathbf{w}), \mathcal{O}_{\mathbb{P}^{m-1}(\mathbf{w})}(n)) = 0$, for $1 \leq s \leq m - 2$ and for all $n \in \mathbb{Z}$.
- (iii) For $n \in \mathbb{N}_0$, the natural map

$$H^0(\mathbb{P}^{m-1}(\mathbf{w}), \mathcal{O}_{\mathbb{P}^{m-1}(\mathbf{w})}(n)) \times H^{m-1}(\mathbb{P}^{m-1}(\mathbf{w}), \mathcal{O}_{\mathbb{P}^{m-1}(\mathbf{w})}(-n - \sum_{i=1}^m w_i)) \rightarrow H^{m-1}(\mathbb{P}^{m-1}(\mathbf{w}), \mathcal{O}_{\mathbb{P}^{m-1}(\mathbf{w})}(-\sum_{i=1}^m w_i)) \cong \mathbb{C}$$

is a perfect pairing.

Definition 2.10. Let $X \xrightarrow{\iota(\mathbf{w})} \mathbb{P}^{m-1}(\mathbf{w})$ be a closed subvariety of $\mathbb{P}^{m-1}(\mathbf{w})$ and

$$p(\mathbf{w}) : \mathbb{P}^{m-1} \rightarrow \mathbb{P}^{m-1}(\mathbf{w}), \quad \pi(\mathbf{w}) : (\mathbb{C}^m \setminus \{0\}) \rightarrow \mathbb{P}^{m-1}(\mathbf{w})$$

the maps introduced in 2.1. $X^{\text{cov}} := p(\mathbf{w})^{-1}(X)$ is defined to be the variety which sits over X via the covering map $p(\mathbf{w})$. $CN^*(X) := \pi(\mathbf{w})^{-1}(X)$ is called *the punctured affine quasicone over X* . The *affine quasicone $CN(X)$ over X* is the scheme-theoretic closure of $CN^*(X)$ in \mathbb{C}^m . The interrelation of these objects to each other can be described by means of two cubes built of commutative diagrams:

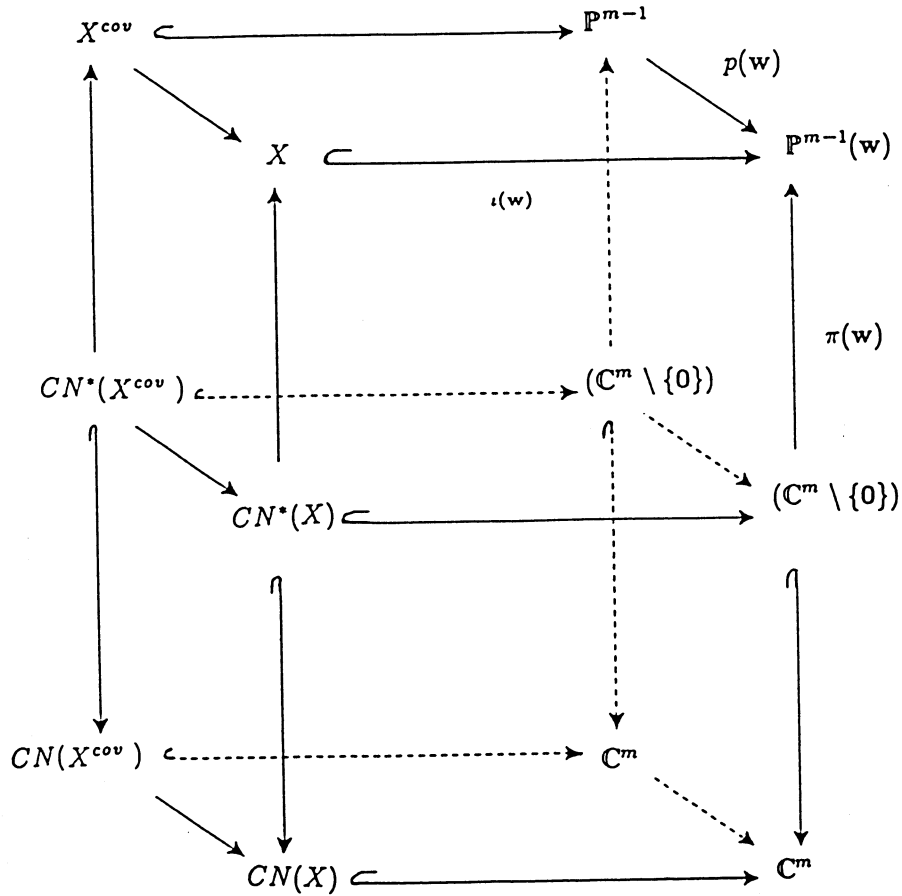

X is said to be *quasismooth* (*q.s.*) if $CN^*(X)$ is overall smooth.

Remark 2.11. We should note here that X can be identified with the geometric quotient $CN^*(X)/\mathbb{C}^*$ with respect to the action, which was introduced in 2.1. Furthermore, the quasismoothness of X does not, in general, offer any guarantee for the smoothness of X^{cov} . Of course, wide classes of quasismooth subvarieties X of $\mathbb{P}^{m-1}(\mathbf{w})$, as for example the class of BP-like complete intersections (see 2.16.) being defined by means of sufficiently general polynomials, have always smooth X^{cov} 's.

Proposition 2.12. (cf. [32, 3.1.6]) All quasismooth closed subvarieties X of $\mathbb{P}^{m-1}(\mathbf{w})$ are V -varieties.

Proof. Let X be the zero locus of the \mathbf{w} -homogeneous polynomials f_1, \dots, f_k ,

$$U_i := \{[z_1, \dots, z_m] \in \mathbb{P}^{m-1}(\mathbf{w}) \mid z_i \neq 0\}$$

the standard cover of $\mathbb{P}^{m-1}(\mathbf{w})$ and

$$V_i := \{(z_1, \dots, z_m) \in \mathbb{C}^m \mid z_i = 1\} \cap CN(X), \forall i, 1 \leq i \leq m.$$

Then

$$V_i = \{(z_1, \dots, z_{i-1}, 1, z_{i+1}, \dots, z_m) \in \mathbb{C}^m \mid f_j(z_1, \dots, z_{i-1}, 1, z_{i+1}, \dots, z_m) = 0, \forall j, 1 \leq j \leq k\}.$$

If we would assume that there were a singular point

$$\mathbf{z}_{(i)}^0 = (z_1^0, \dots, z_{i-1}^0, 1, z_{i+1}^0, \dots, z_m^0)$$

on V_i , then the Euler formula

$$\frac{\partial f_j}{\partial z_i}(\mathbf{z}_{(i)}^0) = -\frac{1}{w_i} \sum_{\substack{l=1 \\ l \neq i}}^m w_l z_l^0 \frac{\partial f_j}{\partial z_l}(\mathbf{z}_{(i)}^0)$$

would imply

$$\text{rank} \left(\frac{\partial(f_1, \dots, f_k)}{\partial(z_1, \dots, z_{i-1}, z_i, z_{i+1}, \dots, z_m)} \Big|_{\mathbf{z}_{(i)}^0} \right) \leq \min(m-1, k) - 1 < \min(m, k),$$

contradicting to the quasismoothness of X . Thus, V_i is smooth and the chart $X \cap U_i$ of X can be represented via $\pi(\mathbf{w})|_{V_i} : V_i \rightarrow X \cap U_i$ as the quotient of V_i by the finite group $(\mathbb{Z}/w_i\mathbb{Z}) \subset \mathbb{C}^*$. \square

Definitions 2.13. (i) A closed subvariety of codimension k in $\mathbb{P}^{m-1}(\mathbf{w})$ is called *well-formed* (or *in general position with respect to $\text{Sing}(\mathbb{P}^{m-1}(\mathbf{w}))$*) if $\mathbb{P}^{m-1}(\mathbf{w})$ is well-formed and X contains no codimension $k+1$ singular stratum of $\mathbb{P}^{m-1}(\mathbf{w})$, i.e. $\text{codim}_X(X \cap \text{Sing}(\mathbb{P}^{m-1}(\mathbf{w}))) \geq 2$.

(ii) If \mathcal{I} is a homogeneous ideal of the graded ring $S(\mathbf{w})$,

$$X = \text{Proj}(S(\mathbf{w})/\mathcal{I}) \subset \mathbb{P}^{m-1}(\mathbf{w})$$

and \mathcal{I} is generated by a regular sequence $\{f_j \mid 1 \leq j \leq k\}$ of homogeneous elements of $S(\mathbf{w})$, then X is called a *weighted projective $(m-k-1)$ -dimensional (strict) complete intersection of the hypersurfaces $\{f_j = 0\}$* (c.i., for short) with *multidegree* $\mathbf{d} := (d_1, \dots, d_k)$, where $\deg(f_j) = d_j, \forall j, 1 \leq j \leq k$. We shall denote $S(\mathbf{w})/\mathcal{I}$ by $A(X)$. $A(X) = \bigoplus_{n \geq 0} A(X)_n$ is a graded \mathbb{C} -algebra with

$$A(X)_n := S(\mathbf{w})_n / (S(\mathbf{w})_n \cap \mathcal{I}) \quad \text{and} \quad \text{Spec}(A(X)) = CN(X).$$

Moreover we shall make use of the notation

$$X_{\mathbf{d}} \subset \mathbb{P}^{m-1}(\mathbf{w})$$

to express a sufficiently general element of the family of all w.c.i. of multidegree \mathbf{d} .

Proposition 2.14. (*Bertini-type quasismoothness criterion*).

Let $X = X_d \subset \mathbb{P}^{m-1}(w_1, \dots, w_m)$ be a c.i. with defining polynomials f_1, \dots, f_k . Then X is quasismooth if and only if for all possible non-empty index-sets $I_r := \{i_1, \dots, i_r\} \subset M := \{1, 2, \dots, m\}$, there exists an integer $s = s(I_r)$, $0 \leq s \leq k$, and a splitting of the index-set $\{1, \dots, k\}$ into:

$$J_{\mathbf{a}} = \begin{cases} \emptyset, & \text{if } s = 0 \\ \{j_1, \dots, j_s\}, & \text{if } 1 \leq s \leq k \end{cases} \quad \text{and} \quad J_{\mathbf{b}} = \begin{cases} \{j_{s+1}, \dots, j_k\}, & \text{if } 0 \leq s \leq k-1 \\ \emptyset, & \text{if } s = k \end{cases}$$

satisfying the following property: In the monomial decomposition of f_1, \dots, f_k

(i) If $J_{\mathbf{a}} \neq \emptyset$, there are at least s monomials of type

$$z_{i_1}^{a_{i_1}^{(j_\alpha)}} \dots z_{i_r}^{a_{i_r}^{(j_\alpha)}}$$

with degree $d_{j_\alpha} ((a_{i_1}^{(j_\alpha)}, \dots, a_{i_r}^{(j_\alpha)}) \in (\mathbb{N}_0)^r \setminus \{(0, \dots, 0)\})$, $\forall \alpha, 1 \leq \alpha \leq s$.

(ii) If $J_{\mathbf{b}} \neq \emptyset$, and if for all $\beta, s+1 \leq \beta \leq k$, we set

$$N_r^{(j_\beta)} := \{n \in M \setminus I_r \mid \exists (b_{i_1}^{(j_\beta), n}, \dots, b_{i_r}^{(j_\beta), n}) \in (\mathbb{N}_0)^r : \\ b_{i_1}^{(j_\beta), n} w_{i_1} + \dots + b_{i_r}^{(j_\beta), n} w_{i_r} + w_n = d_{j_\beta}\},$$

$\nu(j_\beta) := \#(N_r^{(j_\beta)})$ and $N_r^{(j_\beta)} = \{y_1^{(j_\beta)}, \dots, y_{\nu(j_\beta)}^{(j_\beta)}\}$ is an enumeration of $N_r^{(j_\beta)}$, then there exist $\nu(j_\beta)$ monomials of degree d_{j_β}

(namely that of type $z_{i_1}^{b_{i_1}^{(j_\beta), y_\lambda}^{(j_\beta)}} \dots z_{i_r}^{b_{i_r}^{(j_\beta), y_\lambda}^{(j_\beta)}} \cdot z_{y_\lambda}^{(j_\beta)}$, $1 \leq \lambda \leq \nu(j_\beta)$) with

$$|\{\bigcup_{\sigma=1}^{\tau} \bigcup_{\lambda=1}^{\nu(j_{i_\sigma})} y_\lambda^{(j_{i_\sigma})}\}| \geq r - s + \tau - 1, \quad \text{for all subsets } \{i_1, \dots, i_\tau\} \subset \{s+1, \dots, k\}$$

consisting of τ elements, $1 \leq \tau \leq k - s$.

(Note that the above conditions (i) and (ii) hold true for f_1, \dots, f_k “general enough”. This means that the parametrization locus of the non-zero coefficients of (f_1, \dots, f_k) satisfying (i) and (ii) forms a Zariski-open dense subset of $\prod_{j=1}^k \mathbb{C}^{A_j}$.)

Sketch of proof. We generalize similar results of Fletcher [41, § I.5.] being valid for $k = 1$ and $k = 2$. In fact, one has to show that for a “generic choice” of the defining polynomials f_1, \dots, f_k , the rank of the Jacobian matrix $\left(\frac{\partial(f_1, \dots, f_k)}{\partial(z_1, \dots, z_m)} \Big|_{z=z^0}\right)$ evaluated at a point $z^0 \in CN(X)$ cannot be $< k$, except possibly for $z^0 = \mathbf{0}$. Assume that (i) and (ii) hold for each $I_r \neq \emptyset$. By Bertini’s theorem, the singularities of $CN(X)$ can occur only within $CN(X) \cap P_r$, where $P_r := \{(z_1, \dots, z_m) \in \mathbb{C}^m \mid z_{i_{r+1}} = \dots = z_{i_m} = 0\}$ and $\{i_{r+1}, \dots, i_m\} = \{1, \dots, m\} \setminus \{i_1, \dots, i_r\}$.

Let \bar{P}_r be the stratum $\bar{P}_r := \{(z_1, \dots, z_m) \in P_r \mid z_{i_1} \neq 0, \dots, z_{i_r} \neq 0\}$. We expand our polynomials in terms of the variables $z_{i_{r+1}}, \dots, z_{i_m}$:

$$f_\alpha(\mathbf{z}) = g_\alpha(z_{i_1}, \dots, z_{i_r}) + \sum_{l=r+1}^m z_{i_l} h_\alpha^{i_l}(z_{i_1}, \dots, z_{i_r}) + \left\{ \begin{array}{l} \text{higher order terms} \\ \text{in } z_{i_{r+1}}, \dots, z_{i_m} \end{array} \right\}$$

$$f_\beta(\mathbf{z}) = \sum_{l=r+1}^m z_{i_l} h_\beta^{i_l}(z_{i_1}, \dots, z_{i_r}) + \left\{ \begin{array}{l} \text{higher order terms} \\ \text{in } z_{i_{r+1}}, \dots, z_{i_m} \end{array} \right\}$$

for $1 \leq \alpha \leq r$, $s+1 \leq \beta \leq k$, with $g_\alpha, h_\alpha^{i_l}, h_\beta^{i_l}$ suitable polynomials in the variables z_{i_1}, \dots, z_{i_r} .

(a) Suppose first $s = k$. \bar{P}_r is not a part of the base loci $\text{Bs}(\mathbf{L}_j)$ of the linear systems

$$\mathbf{L}_j = \left\{ F_j(z_1, \dots, z_m; \lambda_{(a_1, \dots, a_m)}) = \sum \lambda_{(a_1, \dots, a_m)} z_1^{a_1} \dots z_m^{a_m}, \lambda_{(a_1, \dots, a_m)} \in \mathbb{C}^{\mathcal{A}_j} \right\},$$

$\mathcal{A}_j := \{(a_1, \dots, a_m) \in (\mathbb{N}_0)^m \mid \sum_{i=1}^m a_i w_i = d_j\}$, $1 \leq j \leq k$, parametrizing all quasihomogeneous polynomials of degree d_j w.r.t. the weights (w_1, \dots, w_m) . Thus $(f_j = 0)$ is non-singular along \bar{P}_r , $\forall j$, $1 \leq j \leq k$. Since $(g_\alpha = 0)$, $1 \leq \alpha \leq r$, determine free linear systems on \bar{P}_r , $\{dg_\alpha(\mathbf{z}^0) \mid 1 \leq \alpha \leq r\}$ are linearly independent for $\mathbf{z}^0 \in \bar{P}_r \cap \text{CN}^*(X)$. Hence, the transversality condition is fulfilled and $(\bigcap_{\alpha=1}^r (g_\alpha = 0) \cap \bar{P}_r) \setminus \{\mathbf{0}\} = \bar{P}_r \cap \text{CN}^*(X)$ is non-singular.

(b) Suppose now that $s \neq k$. By Bertini's theorem, $(f_\alpha = 0)$, $1 \leq \alpha \leq r$, are non-singular along \bar{P}_r . This means that

$$\text{Sing}(\text{CN}(X)) = (\bigcap_{\alpha=1}^r (g_\alpha = 0)) \cap (\bigcap_{\substack{j+1 \leq \beta \leq k \\ r+1 \leq l \leq m}} (h_\beta^{i_l} = 0)).$$

It is an exercise of linear algebra to verify (from the above decompositions of f_α and f_β) that (i) and (ii) are equivalent to $\dim_{\mathbb{C}}(\text{Sing}(\text{CN}(X))) = 0$, i.e. that the locus of $\text{CN}(X)$ consisting of that points, at which the Jacobian matrix has rank $\leq k-1$, is zero-dimensional. As $\text{CN}^*(X)$ is \mathbb{C}^* -invariant (cf. 2.11.), we get $\text{Sing}(\text{CN}(X)) \subset \{\mathbf{0}\}$. The converse can be proven similarly. \square

Proposition 2.15. ([32, pr.2], [41, I.3.12, I.3.13]) A c.i. $X_{\mathbf{d}} \subset \mathbb{P}^{m-1}(\mathbf{w})$ is well formed if and only if $X_{\mathbf{d}}$ satisfies one of the following equivalent conditions:

(i)

(a) $\mathbb{P}^{m-1}(\mathbf{w})$ is well-formed and

(b) for all $p = 1, \dots, k$, the gcd of any $(m-k-2+p)$ of the w_i 's divides at least p of the d_j 's.

(ii) $m-k - \#\{i \in \{1, \dots, m\} : q \mid w_i\} + \#\{j \in \{1, \dots, k\} : q \mid d_j\} \geq 2$, for all integers $q \geq 2$. (In particular, if $X_{\mathbf{d}}$ is quasismooth, then $X_{\mathbf{d}}$ is well-formed if and only if the above inequality is true for all prime numbers $q \geq 2$.)

Definition 2.16. A c.i. of the form

$$(2.2) \quad X_{\mathbf{d}} = X_{(d_1, \dots, d_k)} = \{[z_1, \dots, z_m] \in \mathbb{P}^{m-1}(\mathbf{w}) \mid \sum_{i=1}^m \lambda_{ij} z_i^{\alpha_{ij}} = 0, \forall j, 1 \leq j \leq k\}$$

is called c.i. of *Brieskorn-Pham type* (*BP c.i.*, for short). Especially, if either $k = 1$ or $d_1 = \dots = d_k, k \geq 2$, $X_{\mathbf{d}}$ is called c.i. of *Fermat type*. A *BP-like c.i.* is defined to be a c.i. $X_{\mathbf{d}} \subset \mathbb{P}^{m-1}(\mathbf{w})$, for which $\text{lcm}(w_1, \dots, w_m) | d_j, \forall j, 1 \leq j \leq k$.

Using Prop. 2.15, we can easily verify, that any q.s. BP-like c.i., embedded in a well-formed w.p.s., is itself well-formed. The property of well-formedness of a q.s.c.i. turns out to be very important, but it was eluded by the authors of [32] and [10]. In fact, the following theorem, due to Dimca and Fletcher, reduces the examination of the validity of this property to dimension ≤ 2 .

Theorem 2.17. *Let $X_{\mathbf{d}} \subset \mathbb{P}^{m-1}(\mathbf{w})$ be a q.s.c.i. of dimension ≥ 3 . Then either $X_{\mathbf{d}}$ is well-formed, or $X_{\mathbf{d}}$ is the intersection of a linear cone with other hypersurfaces (i.e. $d_j = w_i$ for some j and i). In the second case, $X_{\mathbf{d}}$ is isomorphic either to a q.s.c.i. of lower codimension or to a w.p.s.*

Proposition 2.18. ([30, prop. 8]) *The singular locus of a well-formed q.s.c.i. $X_{\mathbf{d}} \subset \mathbb{P}^{m-1}(\mathbf{w})$ is given by the intersection $\text{Sing}(X_{\mathbf{d}}) = X_{\mathbf{d}} \cap \text{Sing}(\mathbb{P}^{m-1}(\mathbf{w}))$, i.e. $\text{Sing}(X_{\mathbf{d}}) = \bigcup_{I \subset \{1, \dots, m\}} \{X_{\mathbf{d}}(I) | c_I > 1\}$, where $X_{\mathbf{d}}(I) := X_{\mathbf{d}} \cap \mathbb{P}_I$ in the notation of 2.5.*

Proof. If N is a common multiple of the weights w_1, \dots, w_m with $n_i := \frac{N}{w_i}, \forall i, 1 \leq i \leq m$, and $Z := \{[z_1, \dots, z_m] \in \mathbb{P}^{m-1}(\mathbf{w}) | f_{k+1}(z_1, \dots, z_{k+1}) := \lambda_1 z_1^{n_1} + \dots + \lambda_m z_m^{n_m} = 0\}$, then $Z \cap X$ is again a quasismooth complete intersection for coefficients $\lambda_1, \dots, \lambda_m$ general enough (cf. prop. 2.14). Under this quasismoothness assumption,

$$W := \{[z_1, \dots, z_m, z_{m+1}] \in \mathbb{P}^m(w_1, \dots, w_m, 1) | f_1(z_1, \dots, z_m) = \dots = f_k(z_1, \dots, z_m) = f_{k+1}(z_1, \dots, z_m) - z_{m+1}^N = 0\}$$

is also a q.s.c.i and the branching locus $B(g)$ of the natural covering map

$$W \ni [z_1, \dots, z_{m+1}] \xrightarrow{g} [z_1, \dots, z_m] \in X$$

is $B(g) = \{[z_1, \dots, z_m] \in X | \#(g^{-1}([z_1, \dots, z_m])) < N\} = (X \cap \text{Sing}(\mathbb{P}^{m-1}(\mathbf{w}))) \cup (Z \cap X)$ with $\text{cod}_{X \cap \text{Sing}(\mathbb{P}^{m-1}(\mathbf{w})) \setminus (Z \cap X)}(B(g)) \geq 2$. This means that $X \cap \text{Sing}(\mathbb{P}^{m-1}(\mathbf{w})) \subset \text{Sing}(X)$ (cf. [31, Cor. 3]). On the other hand, the restriction of the canonical projection $\pi(\mathbf{w})$ to $\pi(\mathbf{w})^{-1}(X \setminus \text{Sing}(\mathbb{P}^{m-1}(\mathbf{w})))$ is a \mathbb{C}^* -bundle. Thus, $X \setminus \text{Sing}(\mathbb{P}^{m-1}(\mathbf{w}))$ is smooth, i.e. $\text{Sing}(X) \subset X \cap \text{Sing}(\mathbb{P}^{m-1}(\mathbf{w}))$. The proof of the assertion is completed by using prop. 2.12. \square

Definition 2.19. Let $X_{\mathbf{d}} \subset \mathbb{P}^{m-1}(\mathbf{w})$ be a q.s.c.i. The number

$$\text{am}(X_{\mathbf{d}}) := \text{am}(\mathbf{w}; \mathbf{d}) := \sum_{j=1}^k d_j - \sum_{i=1}^m w_i$$

will be called *the amplitude* of $X_{\mathbf{d}}$.

Proposition 2.20. (*Generalized adjunction formula, [32, 3.3.4], [10, p. 152]*) Let X_d be a well-formed q.s.c.i. Then there exists an isomorphism between its dualizing sheaf and its structure sheaf twisted $\text{am}(\mathbf{w}; \mathbf{d})$ times, i.e.

$$(2.3) \quad \omega_{X_d} \cong \mathcal{O}_{X_d}(\text{am}(\mathbf{w}; \mathbf{d}))$$

(Examples in [41, I.3.15] show that we cannot drop the assumption of well-formedness of X_d !)

Proof. 1st step: Let $j : \text{Reg}(\mathbb{P}^{m-1}(\mathbf{w})) \hookrightarrow \mathbb{P}^{m-1}(\mathbf{w})$ be the natural inclusion of the regular locus of $\mathbb{P}^{m-1}(\mathbf{w})$ into $\mathbb{P}^{m-1}(\mathbf{w})$, $\Omega_{S(\mathbf{w})} := \Omega_{S(\mathbf{w})}^1$ the free module of Kähler \mathbb{C} -differentials of $S(\mathbf{w})$ generated by $\{dz_1, \dots, dz_m\}$, and

$$\hat{\Omega}_{\mathbb{P}^{m-1}(\mathbf{w})}^\ell := (\text{Ker}(\epsilon_\ell : \wedge^\ell \Omega_{S(\mathbf{w})} \longrightarrow \wedge^{\ell-1} \Omega_{S(\mathbf{w})}))^\sim$$

the sheaf associated to the graded kernel of the Koszul complex operator ϵ_ℓ , $\forall \ell, 1 \leq \ell \leq m-1$. Then $\omega_{\mathbb{P}^{m-1}(\mathbf{w})} = j_* \omega_{\text{Reg}(\mathbb{P}^{m-1}(\mathbf{w}))} \cong j_* \Omega_{\text{Reg}(\mathbb{P}^{m-1}(\mathbf{w}))}^{m-1} \cong \tilde{\Omega}_{(\mathbb{P}^{m-1}(\mathbf{w}))}^{m-1} \cong \hat{\Omega}_{(\mathbb{P}^{m-1}(\mathbf{w}))}^{m-1}$ is isomorphic to $\mathcal{O}_{(\mathbb{P}^{m-1}(\mathbf{w}))}(-\sum_{i=1}^m w_i)$ because

$$\text{Ker}(\epsilon_{m-1}) \cong \wedge^m (\oplus_{i=1}^m S(\mathbf{w})(-w_i)) \cong S(\mathbf{w})(-\sum_{i=1}^m w_i).$$

2nd step: The Koszul complex which is associated to f_1, \dots, f_k resolves $S(\mathbf{w})/(f_1, \dots, f_k)$. Applying \sim to this resolution we get an exact sequence of $\mathcal{O}_{(\mathbb{P}^{m-1}(\mathbf{w}))}$ -modules:

$$0 \rightarrow \wedge^k \mathcal{F} \rightarrow \dots \rightarrow \wedge^j \mathcal{F} \rightarrow \dots \rightarrow \mathcal{F} \rightarrow \mathcal{O}_X \rightarrow \mathcal{O}_{(\mathbb{P}^{m-1}(\mathbf{w}))} \rightarrow 0$$

with $\mathcal{F} := \oplus_{j=1}^k \mathcal{O}_X(-d_j)$. Consequently,

$$\begin{aligned} \omega_X &= \text{Ext}_{\mathcal{O}_{(\mathbb{P}^{m-1}(\mathbf{w}))}}^1(\mathcal{O}_{(\mathbb{P}^{m-1}(\mathbf{w}))}, \omega_{(\mathbb{P}^{m-1}(\mathbf{w}))}) \cong \\ &\cong \text{coker}(\text{Hom}_{\mathcal{O}_{(\mathbb{P}^{m-1}(\mathbf{w}))}}(\wedge^{k-1} \mathcal{F}, \omega_{(\mathbb{P}^{m-1}(\mathbf{w}))}) \rightarrow \omega_{(\mathbb{P}^{m-1}(\mathbf{w}))}(\sum_{j=1}^k d_j)) \cong \\ &\cong \mathcal{O}_X \otimes_{\mathcal{O}_{(\mathbb{P}^{m-1}(\mathbf{w}))}} \omega_{(\mathbb{P}^{m-1}(\mathbf{w}))}(\sum_{j=1}^k d_j) \end{aligned}$$

and the assertion follows from the isomorphism of the first step. \square

If $X = X_d \subset \mathbb{P}^{m-1}(\mathbf{w})$ is a q.s.c.i. of dimension $r := m - k - 1$, the degeneration of the spectral sequence $\mathbf{E}_1^{p,q}(X) = H^q(X, \bar{\Omega}_X^p) \implies \mathbb{H}^{p+q}(X, \bar{\Omega}_X^\bullet) = H^{p+q}(X, \mathbb{C})$ of hypercohomology (with respect to the complex $\bar{\Omega}_X^\bullet$) at the term \mathbf{E}_1 gives rise to a filtration on the spaces $H^{p+q}(X, \mathbb{C})$, which coincides with that one of the usual Hodge structure. Hence, X admits a *pure Hodge structure*,

$$\text{Hodge decomposition} \quad H^s(X, \mathbb{C}) \cong \bigoplus_{p+q=s} H^q(X, \bar{\Omega}_X^p),$$

Hodge numbers $h^{p,q}(X) := \dim_{\mathbb{C}} H^q(X, \overline{\Omega}_X^p)$ and Serre duality isomorphisms:

$$H^q(X, \overline{\Omega}_X^p) \cong H^{r-q}(X, \overline{\Omega}_X^{r-q}), \quad \forall p, q, 0 \leq p, q \leq r$$

(cf. [112, § 1]). On the other hand, according to the hard Lefschetz theorem for V -varieties, the maps

$$\mathbf{u}(q; p) : H^p(X, \mathbb{C}) \ni \xi \mapsto c_1^q(\mathbf{L}) \smile \xi \in H^{p+2q}(X, \mathbb{C}),$$

induced by the class of an ample line bundle \mathbf{L} over X , are isomorphisms, such that:

$$H^s(X, \mathbb{C}) \cong \bigoplus_{q \geq 0} \mathbf{u}(q; s-2q)(H_{\text{prim}}^{s-2q}(X, \mathbb{C})), \quad \forall s, 0 \leq s \leq 2r-2,$$

where

$$H_{\text{prim}}^p(X, \mathbb{C}) := \text{Ker}(\mathbf{u}(r-p+1; p) : H^p(X, \mathbb{C}) \rightarrow H^{2r-p+2}(X, \mathbb{C})), \quad \forall p, 0 \leq p \leq r,$$

denote the so called *primitive cohomology groups of X* . As a consequence of the compatibility of the Hodge and Lefschetz decompositions we get:

$$H_{\text{prim}}^s(X, \mathbb{C}) \cong \bigoplus_{p+q=s} H_{\text{prim}}^{p,q}(X, \mathbb{C}),$$

where

$$H_{\text{prim}}^{p,q}(X, \mathbb{C}) := H^q(X, \overline{\Omega}_X^p) \cap \text{Ker}(\mathbf{u}(r-s+1; s)).$$

Moreover, if we set $h_{\text{prim}}^{p,q}(X) := \dim_{\mathbb{C}} H_{\text{prim}}^{p,q}(X, \mathbb{C})$, we obtain:

$$(2.4) \quad h^{p,q}(X) = \sum_{i=0}^p h_{\text{prim}}^{p-i, q-i}(X)$$

and the application of the Lefschetz theorem for hyperplane sections gives the following:

Proposition 2.21. *For a q.s.c.i. $X = X_{\mathbf{d}} \subset \mathbb{P}^{m-1}(\mathbf{w})$ of dimension $r = m - k - 1$, we have:*

$$(2.5) \quad h^{p,q}(X) = \delta_{p,q}, \quad \text{for } p+q \neq r$$

$$(2.6) \quad h_{\text{prim}}^{p,q}(X) = h^{p,q}(X) - \delta_{p,q}, \quad \text{for } (p,q) \neq (0,0)$$

The above invariants (2.5) of X are called the *trivial* ones. The remaining, non trivial and most interesting, invariants of X , and their combinatorial expressions by means of the weights w_1, \dots, w_m and of the degrees of the defining w -homogeneous polynomials of X , have been studied by Hamm [59], [60] and Aleksandrov [2]. For the presentation of their formulae we need to introduce some special notations. Let

$$(2.7) \quad W_0 := 1, \quad W_\lambda(y_1, \dots, y_m) := \sum_{1 \leq i_1 < \dots < i_\lambda \leq m} y_{i_1} \dots y_{i_\lambda}$$

denote the elementary symmetric polynomials in the variables y_1, \dots, y_m with weight $\lambda \in \mathbb{N}_0$,

$$(2.8) \quad D_\lambda(y_1, \dots, y_k) := \sum_{\substack{j_1 + \dots + j_k = \lambda \\ j_1, \dots, j_k \geq 0}} y_1^{j_1} \dots y_k^{j_k}$$

the symmetric polynomials in y_1, \dots, y_k of degree λ , and

$$D_{\lambda, k}(y_1, \dots, y_k) := (-1)^\lambda y_1 \dots y_k D_\lambda(y_1, \dots, y_k)$$

with $D_{0,0} := 1$ and $D_{\lambda,0} := 0, \forall \lambda, \lambda \in \mathbb{N}$.

Theorem 2.22. (Aleksandrov [1], [2, p.447])

Let $X = X_{(d_1, \dots, d_k)} \subset \mathbb{P}^{m-1}(w_1, \dots, w_m)$ be a quasismooth c.i., $A(X)$ its graded coordinate ring and \mathfrak{M} the maximal ideal of $A(X)$ corresponding to the zero point $\mathbf{0} \in CN(X)$. Suppose that the indices of the degrees of its defining polynomials are enumerated in order of size

$$d_1 = \dots = d_{k_1} < d_{k_1+1} = \dots = d_{k_{\tau-1}} < d_{k_{\tau-1}+1} = \dots = d_{k_\tau},$$

so that $k_\tau = k, k_0 = 0$, and set $g_\sigma := k_\sigma - k_{\sigma-1} - 1, \forall \sigma, 1 \leq \sigma \leq \tau$.

Then the Poincaré-series of the graded $A(X)$ -module $H_{\mathfrak{M}}^{m-k-q}(\Omega_{A(X)}^q)$ is given, for $q = 1, \dots, m - k$, by the following formula:

$$(2.9) \quad \mathcal{P}(H_{\mathfrak{M}}^{m-k-q}(\Omega_{A(X)}^q); x) = (-1)^{q+1} \sum_{\sigma=1}^{\tau} x^{(q+1)d_{k_\sigma}} \times$$

$$\times \left\{ \sum_{\substack{\lambda_1 + \lambda_2 + \lambda_3 + \lambda_4 = g_\sigma \\ \lambda_1, \lambda_2, \lambda_3, \lambda_4 \geq 0}} \binom{m-k-q+\lambda_1-1}{m-k-q-1} \binom{q+\lambda_2}{q} x^{-(m-k+\lambda_1+1)d_{k_\sigma}} \times \right.$$

$$\left. \times W_{m-\lambda_3}(\mu_\sigma(x; \mathbf{w})) D_{\lambda_4, k-g_\sigma-1}(\nu_\sigma(x; \mathbf{d})) \right\}$$

where $\mu_\sigma(x; \mathbf{w}), \nu_\sigma(x; \mathbf{d})$ abbreviate the rational function vectors:

$$\mu_\sigma(x; \mathbf{w}) := \left(\frac{x^{d_{k_\sigma} - x^{w_1}}}{x^{w_1 - 1}}, \dots, \frac{x^{d_{k_\sigma} - x^{w_m}}}{x^{w_m - 1}} \right) \quad \text{and}$$

$$\nu_\sigma(x; \mathbf{w}) := \left(\frac{x^{d_1 - 1}}{x^{d_{k_\sigma} - x^{d_1}}}, \dots, \frac{x^{d_{k_\sigma - 1} - 1}}{x^{d_{k_\sigma} - x^{d_{k_\sigma - 1}}}}, \frac{x^{d_{k_\sigma + 1} - 1}}{x^{d_{k_\sigma} - x^{d_{k_\sigma + 1}}}}, \dots, \frac{x^{d_k - 1}}{x^{d_{k_\sigma} - x^{d_k}}} \right)$$

respectively.

Sketch of proof. Let f_1, \dots, f_k be the defining polynomials of X ,

$$X^{(0)} := \mathbb{P}^{m-1}(w), \quad X^{(p)} := X_{(d_1, \dots, d_p)},$$

$$\bar{f}_p := f_p|_{CN(X^{(p-1)})} \quad \text{and} \quad \partial f_p := \sum_{i=1}^m \frac{\partial f_p}{\partial z_i}$$

(w.r.t. a local coordinate system $\{z_1, \dots, z_m\}$ of $\mathbf{0}$), $\forall p, 1 \leq p \leq k$. Furthermore, let

$$\{\Omega_{\mathbb{C}^m}^j \xrightarrow{\partial f_p \wedge} \Omega_{\mathbb{C}^m}^{j+1}, j \in \mathbb{Z}\}$$

denote the Koszul-cocomplex defined by means of the left exterior multiplication by ∂f_p ,

$$\Omega_{CN(X^{(p)})}^j := \Omega_{\text{Spec}(A(X^{(p)}))}^j \cong \Omega_{\mathbb{C}^m}^j / \left(\sum_{l=1}^p f_l \Omega_{\mathbb{C}^m}^j + \partial f_l \wedge \Omega_{\mathbb{C}^m}^{j-1} \right) |_{CN(X^{(p)})}$$

and $\Omega_{f_p}^j := \Omega_{CN(X^{(p-1)})}^j / \partial \bar{f}_p \wedge \Omega_{CN(X^{(p-1)})}^{j-1}, \forall p, 1 \leq p \leq k, \forall j, j \in \mathbb{Z}$. By general de Rham-type lemma (see [50, Prop. 1.7. and Prop. 1.11.(i), pp. 241-242]) the sequences

$$(2.10) \quad 0 \rightarrow \Omega_{f_p}^j \xrightarrow{\partial f_p \wedge} \Omega_{CN(X^{(p-1)})}^{j+1} \rightarrow \Omega_{f_p}^{j+1} \rightarrow 0$$

$$(2.11) \quad 0 \rightarrow \Omega_{f_p}^j \xrightarrow{f_p} \Omega_{f_p}^j \rightarrow \Omega_{CN(X^{(p)})}^j \rightarrow 0$$

are exact, $\forall j, 0 \leq j \leq m - p$. The application of the functor $H_{\{0\}}^q(-)$ to (2.10) and (2.11), combined with Greuel's vanishing theorems ([51, pp.165-166]):

$$H_{\{0\}}^q(\Omega_{CN(X^{(p)})}^j) = 0,$$

$$\text{for } \begin{cases} j + q \notin \{m - k, m - k + 1\}, \\ (j, q) \notin \{(i, m - k) | 0 \leq i \leq m - k\} \cup \{(i, 0) | m - k \leq i \leq m\} \end{cases}$$

and

$$H_{\{\mathbf{0}\}}^q(\Omega_{f_p}^j) = 0,$$

$$\text{for } \begin{cases} j + q \neq m - k - 1, \\ (j, q) \notin \{(i, m - k - 1) | 0 \leq i \leq m - k\} \cup \{(i, 0) | m - k + 1 \leq i \leq m\} \end{cases}$$

respectively, leads to four-term exact sequences of cohomology groups supported at $\{\mathbf{0}\}$. The corresponding Poincaré-series must therefore satisfy the following recursive equations:

$$(2.12) \quad \mathcal{P}(H_{\{\mathbf{0}\}}^q(\Omega_{f_p}^{m-p-q+1}); x) = x^{-d_p} \mathcal{P}(H_{\{\mathbf{0}\}}^{q-1}(\Omega_{f_p}^{m-p-q+2}); x) + \mathcal{P}(H_{\{\mathbf{0}\}}^q(\Omega_{CN(X^{(k-p)})}^{m-k-p}); x) - \mathcal{P}(H_{\{\mathbf{0}\}}^{q-1}(\Omega_{CN(X^{(k-p+1)})}^{m-k-q+1}); x) \\ \text{for } 1 \leq p \leq k, 1 \leq q \leq m - p$$

$$(2.13) \quad \mathcal{P}(H_{\{\mathbf{0}\}}^q(\Omega_{CN(X^{(k-p)})}^{m-p-q}); x) = \mathcal{P}(H_{\{\mathbf{0}\}}^{q-1}(\Omega_{CN(X^{(k-p)})}^{m-p-q+1}); x) + (1 - x^{d_p}) \mathcal{P}(H_{\{\mathbf{0}\}}^q(\Omega_{f_p}^{m-p-q+1}); x) \\ \text{for } 1 \leq p \leq k, 1 \leq q \leq m - p - 1$$

The system of (2.12) and (2.13) has as solution:

$$(2.14) \quad \mathcal{P}(H_{\{\mathbf{0}\}}^q(\Omega_{CN(X^{(k-p)})}^{m-p-q}); x) = (-1)^{q-1} \sum_{j=p}^{k-1} \mathcal{P}(H_{\{\mathbf{0}\}}^0(\Omega_{CN(X^{(k-j)})}^{m-j-q}); x) \text{Res}_{t=0} \left[t^{-q} \frac{x^{-d_{k-j}}}{1 + tx^{-d_{k-j}}} \prod_{i=k-j+1}^{k-p} \frac{x^{-d_i} - 1}{1 + tx^{-d_i}} \right]$$

for $0 \leq p \leq k, 1 \leq q \leq m - p - 1$. The theorem is completed by using Grothendieck's local duality theorem [55, thm. 6.3.], which gives a perfect pairing

$$H_{\{\mathbf{0}\}}^{m-k-q}(\Omega_{CN(X^{(k)})}^q) \times \text{Ext}_{\mathcal{O}_{CN(X^{(k)})}}^q(\Omega_{CN(X^{(k)})}^q, \omega_{CN(X^{(k)})}) \rightarrow \mathbb{C},$$

and enables the computation of the Poincaré-series of the desired local cohomology groups, Greuel's and Hamm's computation of $\mathcal{P}(H_{\{\mathbf{0}\}}^0(\Omega_{CN(X^{(k-j)})}^{m-j-q}); x)$ in (2.14) (see [52, Satz 3.1.]), simple duality for the highest dimension $q = m - p$, and "residue-acrobatics" with the symmetric polynomials (2.7), (2.8) (see [52, 3.9]), combined with

$$\mathcal{P}(H_{\mathfrak{m}}^{m-k-q}(\Omega_{A(X)}^q); x) = \mathcal{P}(H_{\{\mathbf{0}\}}^{m-k-q}(\Omega_{CN(X)}^q); x).$$

□

Lemma 2.23. Let $m \in \mathbb{N}$, $\mathbf{w} = (w_1, \dots, w_m) \in \mathbb{N}^m$, and $\mathbb{P}^{m-1}(\mathbf{w}) = \text{Proj}(S(\mathbf{w}))$ be the corresponding w.p.s. with weights \mathbf{w} . Then:

$$(2.15) \quad \mathcal{P}(S(\mathbf{w}); x) = \frac{1}{\prod_{i=1}^m (1 - x^{w_i})}$$

Proof. It follows directly from Prop. 2.9. \square

Lemma 2.24. For a q.s.c.i $X = X_{\mathbf{d}} \subset \mathbb{P}^{m-1}(\mathbf{w})$ we have:

$$(2.16) \quad \mathcal{P}(A(X); x) = \frac{\prod_{j=1}^k (1 - x^{d_j})}{\prod_{i=1}^m (1 - x^{w_i})}$$

Proof. If we set $S^0 := S(\mathbf{w})$, $S^j := S(\mathbf{w})/(f_1, \dots, f_j)$, $\forall j, 1 \leq j \leq k$, where f_1, \dots, f_k are the defining polynomials of X , then

$$0 \rightarrow S^{j-1}(-d_j) \xrightarrow{f_j} S^{j-1} \rightarrow S^j \rightarrow 0$$

is exact as coming from an $S(\mathbf{w})$ -regular sequence. Thus,

$$\mathcal{P}(S^{j-1}; x) = \mathcal{P}(S^j; x) + x^{d_j} \mathcal{P}(S^{j-1}; x),$$

i.e.

$$\mathcal{P}(S^j; x) = (1 - x^{d_j}) \mathcal{P}(S^{j-1}; x).$$

Substituting (2.15) for $\mathcal{P}(S^0; x)$, we get (2.16). \square

As it has turned out, using either the Hodge filtration [60] or a Gysin-type exact sequence between local cohomology groups [2] and further vanishing theorems, the primitive parts of the non-trivial Hodge numbers of such an X are given by means of residue calculus on the rational functions (2.9) and (2.16):

Theorem 2.25. (*Formulae of Hamm and Aleksandrov*)

Let $X = X_{\mathbf{d}} \subset \mathbb{P}^{m-1}(\mathbf{w})$ be a q.s.c.i. of dimension $r = m - k - 1$. Then its non-trivial primitive Hodge numbers are computed by the following formulae, depending only on \mathbf{w} and \mathbf{d} :

$$(2.17) \quad h_{\text{prim}}^{p,q}(X) = h_{\text{prim}}^{q,p}(X) = \text{Res}_{x=0} \frac{1}{x} \mathcal{P}(H_{\text{gr}}^{m-k-q}(\Omega_{A(X)}^q); x), \quad \text{for } 1 \leq q < r, p+q = r$$

$$(2.18) \quad h_{\text{prim}}^{r,0}(X) = h_{\text{prim}}^{0,r}(X) = \text{Res}_{x=0} \frac{1}{x^{\text{am}(\mathbf{w}, \mathbf{d})+1}} \mathcal{P}(A(X); x)$$

The forthcoming numbers, which are of fundamental importance and characterize q.s.c. intersections X , are the dimensions of their cohomology groups with coefficients taken from the twisted sheaves $\mathcal{O}_X(n)$.

Definition 2.26. Let $m \in \mathbb{N}$ and $\mathbf{w} = (w_1, \dots, w_m)$ an m -tuple of positive integers. We denote by $pt(n; \mathbf{w}), n \in \mathbb{N}_0$, the generating function determined by

$$(2.19) \quad \frac{1}{\prod_{i=1}^m (1 - x^{w_i})} = \sum_{n=0}^{\infty} pt(n; \mathbf{w}) x^n$$

(For reasons of convention we extend it to the whole \mathbb{Z} by setting

$$pt(n; \mathbf{w}) = 0, \forall n, n \in \mathbb{Z} \setminus \mathbb{N}_0).$$

Obviously, $pt(n; \mathbf{w}) = \dim_{\mathbb{C}}(S(\mathbf{w})_n) = h^0(\mathbb{P}^{m-1}(\mathbf{w}), \mathcal{O}_{\mathbb{P}^{m-1}(\mathbf{w})}(n))$.

Theorem 2.27. Let $X = X_{\mathbf{d}} \subset \mathbb{P}^{m-1}(\mathbf{w})$ be a well-formed q.s.c.i. of dimension $r = m - k - 1$, whose ideal \mathcal{I} is generated by a regular $S(\mathbf{w})$ -sequence $\{f_1, \dots, f_k\}$ with $\deg(f_j) = d_j, \mathbf{d} = (d_1, \dots, d_k)$, and $A(X) = S(\mathbf{w})/\mathcal{I}$. Then its cohomology groups with coefficients taken from the twisted sheaves $\mathcal{O}_X(n)$ are related to the graded parts of $A(X)$ by the isomorphisms

$$H^i(X, \mathcal{O}_X(n)) \cong \begin{cases} A(X)_n, & \text{for } i = 0 \\ 0, & \text{for } 1 \leq i \leq r - 1 \text{ or } i \neq 0, r \\ A(X)_{\text{am}(\mathbf{w}, \mathbf{d}) - n}, & \text{for } i = r \end{cases}$$

Moreover, the dimensions of the non-vanishing of them are computed by the following formulae, depending only on \mathbf{w} and \mathbf{d} :

$$(2.20) \quad h^0(X, \mathcal{O}_X(n)) = pt(n; \mathbf{w}) + \sum_{j=1}^k (-1)^j \sum_{1 \leq \nu_1 < \nu_2 < \dots < \nu_j \leq k} pt(n - \sum_{\lambda=1}^j d_{\nu_\lambda}; \mathbf{w})$$

$$(2.21) \quad h^r(X, \mathcal{O}_X(n)) = h^0(X, \mathcal{O}_X(\text{am}(\mathbf{w}, \mathbf{d}) - n)), \forall n, n \in \mathbb{Z}.$$

Proof. For the proof of the first assertion we follow Dolgachev [32, § 3.2.]. We consider at first the long exact sequence

$$\begin{aligned} \dots &\rightarrow H_{\{\mathbf{0}\}}^i(CN(X), \mathcal{O}_{CN(X)}) \rightarrow H^i(CN(X), \mathcal{O}_{CN(X)}) \\ &\rightarrow H^i(CN^*(X), \mathcal{O}_{CN(X)|CN^*(X)}) \cong H^i(CN^*(X), \mathcal{O}_{CN^*(X)}) \\ &\rightarrow H_{\{\mathbf{0}\}}^{i+1}(CN(X), \mathcal{O}_{CN(X)}) \rightarrow H^{i+1}(CN(X), \mathcal{O}_{CN(X)}) \rightarrow \dots \end{aligned}$$

which is associated to the cohomology groups of $CN(X)$ with support $\{\mathbf{0}\} = CN(X) \setminus CN^*(X)$ (see [55, Cor. 1.9., p.9], [56, Exp. II, Cor. 2.9., p.16]). Since $CN(X)$ is an affine variety, we have: $H^i(CN(X); \mathcal{O}_{CN(X)}) = 0, \forall i, i > 0$ (see [61, III.3.5]). Thus, for all $i > 0$: $H^i(CN^*(X), \mathcal{O}_{CN^*(X)}) \cong H_{\{\mathbf{0}\}}^{i+1}(CN(X), \mathcal{O}_{CN(X)})$.

This group vanishes whenever $H_{\mathfrak{m}}^{i+1}(\mathcal{O}_{CN(X)}) \cong H_{\{0\}}^{i+1}(CN(X), \check{\mathcal{O}}_{CN(X)})$ is 0. As $CN(X)$ is an affine c.i., its structure sheaf is Cohen-Macaulay and $H_{\mathfrak{m}}^{i+1}(\mathcal{O}_{CN(X)}) = 0$, for $i + 1 < \dim CN(X) = r + 1$ (cf. [56, Exp. VII, prop. 1.2., cor. 1.4, pp. 78-80]). Furthermore,

$$\begin{aligned} H^i(CN^*(X), \mathcal{O}_{CN^*(X)}) &\cong H^i(CN^*(X), \mathcal{O}_X \otimes_{\mathcal{O}_{\mathbb{P}^{m-1}(\mathbf{w})}} \mathcal{O}_{(\mathbb{C}^m \setminus \{0\})}) = \\ &= H^i(X, \mathcal{O}_X \otimes_{\mathcal{O}_{\mathbb{P}^{m-1}(\mathbf{w})}} \pi(\mathbf{w})_* \mathcal{O}_{(\mathbb{C}^m \setminus \{0\})}) = \\ &= \bigoplus_{n \in \mathbb{Z}} H^i(X, \mathcal{O}_X \otimes_{\mathcal{O}_{\mathbb{P}^{m-1}(\mathbf{w})}} \mathcal{O}_{\mathbb{P}^{m-1}(\mathbf{w})}(n)) \cong \bigoplus_{n \in \mathbb{Z}} H^i(X, \mathcal{O}_X(n)). \end{aligned}$$

This means that $H^i(X, \mathcal{O}_X(n)) = 0$, $\forall i$, $1 \leq i \leq r - 1$. Now since $A(X)$ is integrally closed, the Serre homomorphism $A(X) \rightarrow \bigoplus_{n \in \mathbb{Z}} H^0(X, \mathcal{O}_X(n))$, as in the unweighted case ([61, p. 188]), is a graded isomorphism, and therefore by (2.16)

$$\mathcal{P}(X; x) = \mathcal{P}(A(X); x) = \left(\prod_{j=1}^k (1 - x^{d_j}) \right) \left(\prod_{i=1}^m (1 - x^{w_i}) \right)^{-1}.$$

We write

$$\begin{aligned} \prod_{j=1}^k (1 - x^{d_j}) &= \prod_{j=1}^k \left(\sum_{n=0}^{\infty} (\delta_{\{0\}}(n) - \delta_{\{d_j\}}(n)) x^n \right) = \\ &= \sum_{n=0}^{\infty} [(\delta_{\{0\}}(n) - \delta_{\{d_1\}}(n)) \star \dots \star (\delta_{\{0\}}(n) - \delta_{\{d_k\}}(n))] x^n \end{aligned}$$

where \star denotes here the usual Cauchy multiplication. One checks directly that

$$\begin{aligned} &(\delta_{\{0\}}(n) - \delta_{\{d_1\}}(n)) \star \dots \star (\delta_{\{0\}}(n) - \delta_{\{d_k\}}(n)) = \\ &= \begin{cases} 1, & \text{for } n = 0 \\ -1, & \text{for } n = d_{\nu_1} + \dots + d_{\nu_j}, 1 \leq \nu_1 < \dots < \nu_j \leq k, j \text{ odd} \\ 1, & \text{for } n = d_{\nu_1} + \dots + d_{\nu_j}, 1 \leq \nu_1 < \dots < \nu_j \leq k, j \text{ even} \\ 0, & \text{otherwise} \end{cases} \end{aligned}$$

After multiplication by $\prod_{i=1}^m (1 - x^{w_i})^{-1}$ we get (2.20).

Finally, the last isomorphism and (2.21) follow from Serre duality. \square

Corollary 2.28. *For a well-formed q.s.c.i. $X = X_{\mathbf{d}} \subset \mathbb{P}^{m-1}(\mathbf{w})$ of dimension $r = m - k - 1$ we get:*

$$(2.22) \quad h^i(X, w_X(n)) = \begin{cases} h^0(X, \mathcal{O}_X(\text{am}(\mathbf{w}, \mathbf{d}) + n)), & \text{for } i = 0 \\ 0, & \text{for } 1 \leq i \leq r - 1 \\ h^0(X, \mathcal{O}_X(-n)), & \text{for } i = r \end{cases}$$

Proof. Obvious by the generalized adjunction formula (2.3) of prop. 2.20. \square

Definition 2.29. Let $X = X_{\mathbf{d}} \subset \mathbb{P}^{m-1}(\mathbf{w})$ be a q.s.c.i and $\bar{\mathbf{w}}$ be the reduction of the weights \mathbf{w} (as in 2.2). If f_1, \dots, f_k are the defining \mathbf{w} -homogeneous polynomials of X , we shall say that $\bar{X} = \bar{X}_{\bar{\mathbf{d}}} \subset \mathbb{P}^{m-1}(\bar{\mathbf{w}})$, defined by the $\bar{\mathbf{w}}$ -homogeneous polynomials f_1, \dots, f_k with degrees $\deg(\bar{f}_j) = \bar{d}_j := \frac{d_j}{\gcd(w_1, \dots, w_m)}$, is the \mathbf{w} -reduction of X . Furthermore, if we suppose that \bar{X} is not contained in any hyperplane $\{z_i = 0\}$, for $1 \leq i \leq m$, then we can determine a third q.s.c.i $X' = X'_{\mathbf{d}'} \subset \mathbb{P}^{m-1}(\mathbf{w}')$ coming from the *normalization* \mathbf{w}' of \mathbf{w} (in the notation of 2.2.) with defining \mathbf{w}' -homogeneous polynomials f'_1, \dots, f'_k of degrees

$$\deg(f'_j) = d'_j := \frac{\bar{d}_j}{\text{lcm}(\rho_1(\mathbf{w}), \dots, \rho_m(\mathbf{w}))}, \quad \forall j, 1 \leq j \leq k.$$

(cf. [30, p. 186]).

Proposition 2.30. ([30, pp. 186-187]). Let $X = X_{\mathbf{d}} \subset \mathbb{P}^{m-1}(\mathbf{w})$ be a q.s.c.i and \bar{X} its \mathbf{w} -reduction. Assume that \bar{X} is not contained in any hyperplane $\{z_i = 0\}$, for $1 \leq i \leq m$, and let X' denote the q.s.c.i coming from the normalization \mathbf{w}' of \mathbf{w} . Then X, \bar{X} and X' are isomorphic to each other.

Remark 2.31. The above mentioned proposition informs us that under these relatively weak assumptions, we can consider the weights of q.s.c. intersections being normalized. Of course, this does not mean that the corresponding germs $(CN(X), \mathbf{0}), (CN(\bar{X}), \mathbf{0}), (CN(X'), \mathbf{0})$ will have to be necessarily isomorphic.

Definition 2.32. A q.s.c.i $X = X_{\mathbf{d}} \subset \mathbb{P}^{m-1}(\mathbf{w})$ will be called *nondegenerate* if it has the following properties:

- (a) its \mathbf{w} -reduction \bar{X} is not contained in any hyperplane $\{z_i = 0\}$, for $1 \leq i \leq m$, and
- (b) X' fulfills, in addition, the condition (i) (b) of Prop. 2.15., i.e. X' is well-formed.

Proposition 2.33. The degree of the twisted sheaf $\mathcal{O}_X(n)$, which is defined over a nondegenerate one dimensional q.s.c.i $X = X_{\mathbf{d}} \subset \mathbb{P}^{m-1}(\mathbf{w})$, is given by the formula:

$$(2.23) \quad \deg(\mathcal{O}_X(n)) = \frac{1}{\gcd(w_1, \dots, w_m)} \{h^0(X', \mathcal{O}_{X'}(\theta(n; \mathbf{w})) - h^0(X', \mathcal{O}_{X'}(\text{am}(\mathbf{d}', \mathbf{w}') - \theta(n; \mathbf{w}))) + g(X') - 1\}$$

where X' denotes the space coming from the normalization \mathbf{w}' of \mathbf{w} , $\theta(n; \mathbf{w})$ the function (2.1) introduced in 2.6., and $g(X') := h^1(X', \mathcal{O}_{X'}) = h^0(X', \mathcal{O}_{X'}(\text{am}(\mathbf{d}', \mathbf{w}')))$ its genus.

Proof. By prop. 2.7.,

$$\deg(\mathcal{O}_X(n)) = \frac{1}{\gcd(w_1, \dots, w_m)} \deg(\mathcal{O}_{\bar{X}}(n)) = \frac{1}{\gcd(w_1, \dots, w_m)} \deg(\mathcal{O}_{X'}(\theta(n; \mathbf{w}))).$$

Since X' is well-formed and smooth, the usual Riemann-Roch formula for curves gives:

$$\deg(\mathcal{O}_{X'}(\theta(n; \mathbf{w}))) = h^0(X', \mathcal{O}_{X'}(\theta(n; \mathbf{w}))) - h^1(X', \mathcal{O}_{X'}(\theta(n; \mathbf{w}))) + (g(X') - 1).$$

The proof is completed by using the Serre duality equation

$$h^1(X', \mathcal{O}_{X'}(\theta(n; \mathbf{w}))) = h^0(X', \mathcal{O}_{X'}(\text{am}(\mathbf{d}', \mathbf{w}') - \theta(n; \mathbf{w}))).$$

□

Let us now go into the description of the nature of the Picard groups of q.s.c. intersections. Since we are mainly interested in threefolds, we omit the consideration of the surface case referring the reader to Steenbrink [113], Cox [22] and Jong-Steenbrink [67] instead.

Theorem 2.34. (*Mori's weighted version of the classical Noether-Lefschetz theorem, [90, Th. 3.7.]*) The Picard group $\text{Pic}(X)$ of a smooth, well-formed c.i. $X = X_{\mathbf{d}} \subset \mathbb{P}^{m-1}(\mathbf{w})$ of dimension ≥ 3 is isomorphic to \mathbb{Z} and is generated by the class $[\mathcal{O}_X(1)]$.

Theorem 2.35. (*Dolgachev's generalization [32, 3.2.4 (i), 3.2.5]*) The Picard group $\text{Pic}(X)$ of a quasismooth, well-formed c.i. $X = X_{\mathbf{d}} \subset \mathbb{P}^{m-1}(\mathbf{w})$ of dimension ≥ 3 is isomorphic to \mathbb{Z} and is generated by the class of an $\mathbf{L}_X := \mathcal{O}_X(\eta_X)$, for some $\eta_X \in \mathbb{N}$.

Definition 2.36. Let $X = X_{\mathbf{d}}$ be a q.s.c.i. in $\mathbb{P}^{m-1}(\mathbf{w})$, $I \subset \{1, \dots, m\}$ a (non-empty) index set and $X(I)$ the corresponding stratum on X (as in 2.18). (If $\varphi_I : \mathbb{C}[z_1, \dots, z_m] \rightarrow \mathbb{C}[\{z_j | j \in \{1, \dots, m\} \setminus I\}]$ is the canonical coordinate ring epimorphism, then the set $\{\varphi_I(f_1), \dots, \varphi_I(f_k)\}$ contains obviously a minimal set of generators of the defining ideal of $X(I)$ in \mathbb{P}_I .)

We define:

$$\mathcal{V}(I) := k - \#(\text{elements of a minimal set of generators of the ideal of } X(I) \text{ in } \mathbb{P}_I).$$

X will be called *well-stratified* if

(a) $X(I)$ is a $(m - 1 - |I|) - (k - \mathcal{V}(I))$ -dimensional q.s.c.i. for all I with

$$|I| \leq (m - 1) - (k - \mathcal{V}(I)).$$

(b) for all I with $(m - 1 - |I|) - (k - \mathcal{V}(I)) = 0$, $X(I)$ consists of finitely many points.

(c) $X(I) = \emptyset$ for all I with $|I| > (m - 1) - (k - \mathcal{V}(I))$.

(Note that condition (c) is not superfluous! For instance, the intersection of two zero-dimensional hypersurfaces in a w.p.s. need not be empty.)

Next theorem strengthens Dolgachev's result in the well-stratifiedness case, gives a partial answer to a question of Beltrametti and Robbiano for dimension ≥ 3 [10, p. 155], and generalizes prop. 2.8. (iii).

Theorem 2.37. *Let $X = X_{\mathbf{d}} \subset \mathbb{P}^{m-1}(\mathbf{w})$ be a well-formed, well-stratified, q.s.c.i of dimension ≥ 3 . Then $\text{Pic}(X)$ is generated by the class of the ample bundle $\mathbf{L}_X := \mathcal{O}_X(\eta_X)$ with*

$$(2.24) \quad \begin{aligned} \eta_X &= \text{lcm}(\{\text{gcd}(w_i | i \in I) | I \subset \{1, \dots, m\}, |I| \geq k+1 - \mathcal{V}(\{1, \dots, m\} \setminus I)\}) = \\ &= \text{lcm}(\{\text{gcd}(w_i | i \in I) | I \subset \{1, \dots, m\}, |I| = k+1 - \mathcal{V}(\{1, \dots, m\} \setminus I)\}) \end{aligned}$$

Proof. By prop. 2.8. (iii), $\text{Pic}(\mathbb{P}^{m-1}(\mathbf{w}))$ is generated by $[\mathcal{O}_{\mathbb{P}^{m-1}(\mathbf{w})}(\text{lcm}(w_1, \dots, w_m))]$. Now, although X^{cov} is a not necessarily smooth c.i. (see 2.11.), $\text{Pic}(X^{cov})$ is generated by $[\mathcal{O}_{X^{cov}}(1)]$, $p(\mathbf{w})^*$, $(p(\mathbf{w})|_X)^*$, $\iota(\mathbf{w})^*$ are injective and $\iota(\mathbf{1})^*$ is an isomorphism by Grothendieck's version of Noether-Lefschetz theorem ([56, Exp. XII, Cor. 3.6. and 3.7., p. 153]).

$$\begin{array}{ccc} \mathbb{Z} = \text{Pic}(\mathbb{P}^{m-1}) & \xleftarrow{p(\mathbf{w})^*} & \text{Pic}(\mathbb{P}^{m-1}(\mathbf{w})) = \text{lcm}(w_1, \dots, w_m)\mathbb{Z} \\ \iota(\mathbf{1})^* \downarrow & & \downarrow \iota(\mathbf{w})^* \\ \mathbb{Z} = \text{Pic}(X^{cov}) & \xleftarrow{(p(\mathbf{w})|_X)^*} & \text{Pic}(X) = \eta_X \mathbb{Z} \end{array}$$

Thus, $\text{Pic}(X)$ is generated by the class of the ample line bundle $\mathbf{L}_X = \mathcal{O}_X(\eta_X)$, where η_X denotes the minimal positive integer which divides $\text{lcm}(w_1, \dots, w_m)$ and for which $(p(\mathbf{w})|_X)^*(\mathcal{O}_X(\eta_X)) = \mathcal{O}_{X^{cov}}(\eta_X)$. In other words, η_X is the minimal divisor of $\text{lcm}(w_1, \dots, w_m)$ for which

$$H^0(\text{Spec}(A(X)_{(h)}), \mathcal{O}_X(\eta_X)) = A(X)(\eta_X)_{(h)} = \left\{ \frac{g}{h^\nu} \mid g \in A(X)_{\nu s + \eta_X} \right\}$$

forms a free $A(X)_{(h)}$ -module of rank 1, for all $h \in A(X)_s$ and for all $s \in \mathbb{N}$. For the determination of η_X we identify X with $CN^*(X)/\mathbb{C}^*$. Note that $\text{Pic}(CN(X)) \cong \text{Pic}(CN^*(X))$ is trivial ([56, Exp. XI, Cor. 3.10., p.130], [32, p.52]). The projection map $\pi(\mathbf{w})|_X$ induces a monomorphism

$$q_X : \text{Pic}(CN^*(X)/\mathbb{C}^*) \hookrightarrow \text{Pic}_{\mathbb{C}^*}(CN^*(X))$$

to the group of isomorphism classes of \mathbb{C}^* -line bundles over $CN^*(X)$. By the exact sequences

$$\begin{array}{c} \{1\} \\ \downarrow \\ \text{Pic}(X) = \text{Pic}(CN^*(X)/\mathbb{C}^*) \\ \downarrow q_X \\ \{1\} \rightarrow H_{alg}^1(\mathbb{C}^*, \text{Aut}(\mathcal{O}_{CN^*(X)})) \cong H_{alg}^1(\mathbb{C}^*, \mathbb{C}^*) \cong \mathbb{Z} \rightarrow \text{Pic}_{\mathbb{C}^*}(CN^*(X)) \rightarrow \text{Pic}(CN^*(X)) = \{1\} \end{array}$$

we deduce that the image of q_X consists of those \mathbb{C}^* -line bundles \mathcal{L} over $CN^*(X)$, for which the isotropy groups $\{(\mathbb{C}^*)_{\mathbf{z}}, \mathbf{z} \in CN^*(X)\}$ act trivially on the fiber $\mathcal{L}_{\mathbf{z}}$ (cf. [75, §4, §5]). As these \mathbb{C}^* -linearizations \mathcal{L}_n of the trivial line bundle

$$CN^*(X) \times \mathbb{C} \rightarrow CN^*(X)$$

are parametrized by $n \in \mathbb{Z}$:

$$\mathcal{L}_n | \mathbb{C}^* \times (CN^*(X) \times \mathbb{C}) \ni (t, (\mathbf{z}, \lambda)) \mapsto (t \cdot \mathbf{z}, t^n \lambda) \in CN^*(X) \times \mathbb{C},$$

for $\mathbf{z} = (z_1, \dots, z_m) \in CN^*(X)$, $t \cdot \mathbf{z} = (t^{w_1} z_1, \dots, t^{w_m} z_m)$,

we have $(\mathbb{C}^*)_{\mathbf{z}} \cong \mathbb{Z}/\gcd(w_i | i \in I_{\mathbf{z}})\mathbb{Z}$, where

$I_{\mathbf{z}} := \{i \in \{1, \dots, m\} | z_i \neq 0\}$ with $|I_{\mathbf{z}}| \geq k + 1 - \mathcal{V}(\{1, \dots, m\} \setminus I_{\mathbf{z}}) \geq 1$.

(The latter inequality comes from the well-stratifiedness of X .) Hence, if we set

$$Q_X(\mathbf{z}) := \{t \in \mathbb{C}^* : t^{w_i} = 1, \forall i, i \in I_{\mathbf{z}}\},$$

we get:

$$\eta_X = \min\{n \in \mathbb{N} | t^n = 1, \text{ for all } t \in \bigcap_{\mathbf{z} \in CN^*(X)} Q_X(\mathbf{z})\}.$$

□

Corollary 2.38. *If $X = X_d$ is a well-formed q.s. hypersurface in $\mathbb{P}^{m-1}(\mathbf{w})$ of dimension ≥ 3 and its defining polynomial is general enough, then:*

(2.25)

$$\eta_X = \text{lcm}(\{\gcd(w_{i_1}, w_{i_2}) | 1 \leq i_1 < i_2 \leq m\} \cup \{w_i, 1 \leq i \leq m, \text{ with } w_i \nmid d\}).$$

Proof. Let $X = (f = 0)$. If the coefficients of f are sufficiently general w.r.t. each stratum (cf. proof of prop. 2.14), then X is well-stratified. For an index set $I \subset \{1, \dots, m\}$ with $|I| = m - 1$ and $\{1, \dots, m\} \setminus I = \{i\}$, \mathbb{P}_I consists only of the point $[0, \dots, 0, 1, 0, \dots, 0]$ with the 1 in the i -th position. X contains this point, i.e. $X(I) \neq \emptyset$ and $\mathcal{V}(I) = 1$, if and only if in the monomial decomposition of its defining polynomial there is no monomial involving only z_i . But this is equivalent to d not being a multiple of w_i . □

Corollary 2.39. *If X is a BP q.s.c.i. (2.2) of dimension ≥ 3 , with $\alpha_{ij} \geq 2$, $\forall i, 1 \leq i \leq m, \forall j, 1 \leq j \leq k$, and all $(p \times p)$ -subdeterminants of the matrix $(\lambda_{ij})_{1 \leq i \leq m, 1 \leq j \leq k}$ are non-zero, $\forall p, 1 \leq p \leq k$, then:*

$$(2.26) \quad \eta_X = \text{lcm}(\{\gcd(w_{i_1}, \dots, w_{i_{k+1}}) | 1 \leq i_1 < i_2 < \dots < i_{k+1} \leq m\})$$

Lemma 2.40. *Let $X = X_{\mathbf{d}} \subset \mathbb{P}^{m-1}(\mathbf{w})$ be a well-formed, well-stratified, q.s.c.i. of dimension $r \geq 3$ and $\mathbf{L}_X = \mathcal{O}_X(\eta_X)$ the generator of its Picard group. Then we have:*

$$(2.27) \quad \mathbf{L}_X^r = \frac{(\prod_{j=1}^k d_j) \eta_X^r}{\prod_{i=1}^m w_i}$$

Proof. It follows directly from the fact, that $(\mathcal{O}_{X^{\text{cov}}}(\eta_X))^r = \eta_X^r(\mathcal{O}_{X^{\text{cov}}}(1))^r = \eta_X^r(\prod_{j=1}^k d_j)$ and $(\mathcal{O}_{X^{\text{cov}}}(\eta_X))^r = \deg(p(\mathbf{w})|_X) \mathbf{L}_X^r$, because

$$\mathcal{O}_{X^{\text{cov}}}(\eta_X) = (p(\mathbf{w})|_X)^*(\mathbf{L}_X) \quad \text{and} \quad \deg(p(\mathbf{w})|_X) = \prod_{i=1}^m w_i.$$

□

Theorem 2.41. *The Δ -genus of a well-formed, well-stratified, q.s.c.i. $X = X_{\mathbf{d}} \subset \mathbb{P}^{m-1}(\mathbf{w})$ of dimension $r \geq 3$ with respect to \mathbf{L}_X is given by the formula:*

$$(2.28) \quad \Delta(X, \mathbf{L}_X) =$$

$$r + \frac{(\prod_{j=1}^k d_j) \eta_X^r}{\prod_{i=1}^m w_i} - pt(\eta_X; \mathbf{w}) - \sum_{j=1}^k (-1)^j \sum_{1 \leq \nu_1 < \nu_2 < \dots < \nu_j \leq k} pt(\eta_X - \sum_{\lambda=1}^j d_{\nu_\lambda}; \mathbf{w})$$

Proof. Obvious by the formulae (2.20) and (2.27). □

Remarks 2.42. (i) All well-formed, well-stratified q.s.c. intersections $X = X_{\mathbf{d}} \subset \mathbb{P}^{m-1}(\mathbf{w})$ with $r = m - k - 1 = 3$ and $\text{am}(X) = 0$ are *minimal CY models of general type*, because they have always (full) crepant desingularizations (see §4), their Picard number equals 1, and $([c_2]_X |_{\overline{\text{Amp}}(X)}) > 0$. These models arose first in the physics literature in connection with the so called “Landau-Ginzburg potentials” which were first introduced in the article of W. Lerche, G. Vafa and N.P. Warner: “Chiral rings in $N = 2$ superconformal theories”, in Nucl. Ph. B, Vol. 324, 1989 (see also [15], [74], [120], [129]). It should be mentioned, that the conditions of quasismoothness, well-formedness (cf. prop. 2.14 and 2.15) and of the vanishing amplitude are in fact very *restrictive*. This is the reason for which the expected degrees $\mathbf{d} = (d_1, \dots, d_k)$ and weights $\mathbf{w} = (w_1, \dots, w_m)$ for these X ’s have to move within *bounded* arithmetical regions and to be, in particular, *finitely many*. For example, there is no CY model of the regarded type with codimension $k \geq 5$, while only the intersection of four quadrics in the usual 7-dimensional projective space appears in codimension 4. For $1 \leq k \leq 3$, however, there are several thousands of allowable combinations $(\mathbf{d}; \mathbf{w})$, the number of which decreases as long as we increase k .

In the case where $k = 1$, Klemm and Schimmrigk [74] and, independently, Kreuzer and Skarke [79], gave a computer aided classification of all possible combinations

for $(d; w_1, \dots, w_5)$. They found 7555 combinations, the table of which covers a lot of pages (see preprint version of [74]). Recently Klemm [73] showed that there exist over 4200 (resp. 300) combinations corresponding to such models of codimension 2 (resp. 3) with $d_1, d_2 \leq 100$ (resp. $d_1, d_2, d_3 \leq 30$).

(ii) In [94, § 5] Oguiso studied polarized CY threefolds by means of their delta genera and came to the remarkable result, that *all* the polarized CY threefolds with $\Delta \leq 2$ have to be complete intersections of codimension ≤ 2 in a w.p.s. In the first step of his method, he makes use of the following Bertini-type theorem due to Fujita:

Theorem 2.43. (Fujita [44], [45]) *Let (X, \mathbf{L}) be a polarized smooth complex variety of dimension $r \geq 3$. Suppose that $\Delta(X, \mathbf{L}) \leq 2$ and $\mathbf{L}^r \geq 2$. Then $\dim \text{Bs}(|\mathbf{L}|) \leq 1$ and all general members of $|\mathbf{L}|$ are smooth.*

If (X, \mathbf{L}) is a polarized CY threefold with $\Delta(X, \mathbf{L}) \leq 2$ and $\mathbf{L}^3 = 1$, then obviously $h^0(X, \mathbf{L}) \in \{2, 3\}$. If $\mathbf{L}^3 \geq 2$, then by 2.43. any general member S of $|\mathbf{L}|$ is smooth with ample canonical divisor $K_S = \mathbf{L}|_S$. This means that S is a minimal surface of general type with geometric genus $p_g(S) = h^0(X, \mathbf{L}) - 1$ and $K_S^2 = \mathbf{L}^3 \geq 2p_g(S) - 4 = 2h^0(X, \mathbf{L}) - 6$ (cf. Noether's inequality [5, ch. VII, thm. 3.1., p. 210]). Thus, for $\Delta(X, \mathbf{L}) = 1$, it is necessarily $(h^0(X, \mathbf{L}), \mathbf{L}^3) \in \{(3, 1), (4, 2)\}$, and for $\Delta(X, \mathbf{L}) = 2$, $(h^0(X, \mathbf{L}), \mathbf{L}^3) \in \{(2, 1), (3, 2), (4, 3), (5, 4)\}$.

Oguiso's analysis on the corresponding graded rings $\bigoplus_{n \geq 0} H^0(X, n\mathbf{L})$ for the above 6 possible values of $(h^0(X, \mathbf{L}), \mathbf{L}^3)$ lead to the following:

Theorem 2.44. (Oguiso's $(\Delta \leq 2)$ -classification [94, thm. 5.1.]) *Let (X, \mathbf{L}) be a polarized CY threefold with delta genus ≤ 2 . Then X is a complete intersection of codimension ≤ 2 in w.p.s. and $\mathbf{L} = \mathbf{L}_X = \mathcal{O}_X(1)$. More precisely, for $\Delta(X, \mathbf{L}) = 1$, X is isomorphic either to an $X_8 \subset \mathbb{P}^4(1, 1, 1, 1, 4)$ or to an $X_{10} \subset \mathbb{P}^4(1, 1, 1, 2, 5)$. For $\Delta(X, \mathbf{L}) = 2$, X can be one of the following: $X_6 \subset \mathbb{P}^4(1, 1, 1, 1, 2)$, $X_{(2,6)} \subset \mathbb{P}^5(1, 1, 1, 1, 1, 3)$, $X_{(3,6)} \subset \mathbb{P}^5(1, 1, 1, 1, 2, 3)$, $X_{(4,6)} \subset \mathbb{P}^5(1, 1, 1, 2, 2, 3)$ or $X_{(6,6)} \subset \mathbb{P}^5(1, 1, 2, 2, 3, 3)$.*

Theorems 2.43 and 2.44 are not true if one drops the assumption of the smoothness of X . Nevertheless, having formula (2.28) in hand, we can give the corresponding tables of CY models expressing well-formed, well-stratified q.s.c. intersections of codimension ≤ 2 in a w.p.s. with $\Delta(X, \mathbf{L}_X) \leq 2$, by using the "big classification tables" which were mentioned in 2.42. (i). The author thanks R. Schimmrigk and A. Klemm for various computer checkings.

Proposition 2.45. (i) *The class of minimal CY models $X = X_d \subset \mathbb{P}^4(\mathbf{w})$, being realized as quasismooth hypersurfaces (with sufficiently general defining polynomials) in a four-dimensional w.p.s., where $(d; \mathbf{w})$'s run through the list of the above mentioned 7555 combinations contains exactly 11 CY models with delta genus $\Delta(X, \mathbf{L}_X) \leq 2$. They are given by the following table:*

Nr.	Model	$X = X_d$	\mathbf{L}_X^3	$[c_2]_X(\mathbf{L}_X)$	$\Delta(X, \mathbf{L}_X)$	$\epsilon(X)$
(1)	$X_6 \subset \mathbb{P}^4$	$(1, 1, 1, 1, 2)$	3	42	2	-204
(2)	$X_8 \subset \mathbb{P}^4$	$(1, 1, 1, 1, 4)$	2	44	1	-296
(3)	$X_{10} \subset \mathbb{P}^4$	$(1, 1, 1, 2, 5)$	1	34	1	-288
(4)	$X_{12} \subset \mathbb{P}^4$	$(1, 2, 2, 3, 4)$	2	32	2	-138
(5)	$X_{12} \subset \mathbb{P}^4$	$(1, 1, 2, 2, 6)$	4	52	2	-250
(6)	$X_{14} \subset \mathbb{P}^4$	$(1, 2, 2, 2, 7)$	2	44	1	-212
(7)	$X_{15} \subset \mathbb{P}^4$	$(1, 3, 3, 3, 5)$	3	42	2	-124
(8)	$X_{18} \subset \mathbb{P}^4$	$(1, 1, 1, 6, 9)$	9	102	2	-542
(9)	$X_{18} \subset \mathbb{P}^4$	$(1, 2, 3, 3, 9)$	3	42	2	-188
(10)	$X_{24} \subset \mathbb{P}^4$	$(1, 1, 2, 8, 12)$	8	92	2	-482
(11)	$X_{36} \subset \mathbb{P}^4$	$(1, 2, 3, 12, 18)$	6	72	2	-362

Note that each of them can be defined by a Fermat polynomial.

(ii) Only 5 models lie on the $(\Delta = 3)$ -line: $[c_2]_X(\mathbf{L}_X) = 10 \mathbf{L}_X^3$, namely $X_5 \subset \mathbb{P}^4$, $X_{16} \subset \mathbb{P}^4(1, 1, 3, 3, 8)$, $X_{20} \subset \mathbb{P}^4(1, 4, 5, 5, 5)$, $X_{26} \subset \mathbb{P}^4(2, 2, 3, 6, 13)$ and $X_{30} \subset \mathbb{P}^4(1, 2, 6, 6, 15)$.

Proof. Apply the formulae (2.25), (2.27), $[c_2]_X(\mathbf{L}_X) = 12 h^0(X, \mathbf{L}_X) - 2 \mathbf{L}_X^3$ (cf. (5.3)) and (2.28) to the table of the 7555 combinations of degrees and weights given in [74]. \square

Similar results can be achieved for codimension $k = 2$.

Proposition 2.46. *There exist exactly 6 well-formed, well-stratified q.s.c. intersections $X = X_{(d_1, d_2)} \subset \mathbb{P}^5(w_1, \dots, w_6)$ with $\text{am}(X) = 0$ and $\Delta(X, \mathbf{L}_X) \leq 2$:*

Nr.	Model	$X = X_{(d_1, d_2)}$	\mathbf{L}_X^3	$[c_2]_X(\mathbf{L}_X)$	$\Delta(X, \mathbf{L}_X)$
(1)	$X_{(2,6)} \subset \mathbb{P}^5(1, 1, 1, 1, 1, 3)$		4	52	2
(2)	$X_{(3,6)} \subset \mathbb{P}^5(1, 1, 1, 1, 2, 3)$		3	42	2
(3)	$X_{(4,6)} \subset \mathbb{P}^5(1, 1, 1, 2, 2, 3)$		2	32	2
(4)	$X_{(6,6)} \subset \mathbb{P}^5(1, 1, 2, 2, 3, 3)$		1	22	2
(5)	$X_{(6,10)} \subset \mathbb{P}^5(2, 2, 2, 2, 3, 5)$		2	44	1
(6)	$X_{(6,12)} \subset \mathbb{P}^5(2, 3, 3, 3, 3, 4)$		3	42	2

Moreover, 5 models of this kind lie on the $(\Delta = 3)$ -line, namely $X_{(4,4)} \subset \mathbb{P}^5(1, 1, 1, 1, 2, 2)$, $X_{(6,8)} \subset \mathbb{P}^5(1, 2, 2, 2, 3, 4)$, $X_{(10,12)} \subset \mathbb{P}^5(1, 3, 3, 4, 5, 6)$, $X_{(10,15)} \subset \mathbb{P}^5(2, 3, 5, 5, 5, 5)$ and $X_{(14,18)} \subset \mathbb{P}^5(2, 2, 6, 6, 7, 9)$.

Proof. If X is a 2-dimensional well-formed, well-stratified q.s.c.i. in $\mathbb{P}^5(\mathbf{w})$, then $\text{Pic}(X)$ is generated by the class of $\mathbf{L}_X = \mathcal{O}_X(\eta_X)$, where η_X , similarly to the hypersurface case of cor. 2.38., is given by $\eta_X = \text{lcm}\{\mathcal{W}_1 \cup \mathcal{W}_2 \cup \mathcal{W}_3\}$, with

$$\mathcal{W}_1 := \{\text{gcd}(w_{i_1}, w_{i_2}, w_{i_3}) \mid 1 \leq i_1 < i_2 < i_3 \leq 6\}$$

$$\mathcal{W}_2 := \{\text{gcd}(w_{i_1}, w_{i_2}) \mid 1 \leq i_1 < i_2 \leq 6 \text{ with either } \text{gcd}(w_{i_1}, w_{i_2}) \nmid d_1 \\ \text{or } \text{gcd}(w_{i_1}, w_{i_2}) \nmid d_2\}$$

$$\mathcal{W}_3 := \{w_i \mid 1 \leq i \leq 6 \text{ such that } w_i \nmid d_1 \text{ and } w_i \nmid d_2\}.$$

Applying the formula (2.28) for this η_X to the combinations of $(\mathbf{d}; \mathbf{w})$'s which were found by [73], and taking into account that Δ grows rapidly after the first steps of a search procedure, we get only the above cases fulfilling the requirement $\Delta \leq 3$. \square

Remarks 2.47. (i) The complete classification of *all* polarized CY models with delta genus ≤ 2 remains an open problem. Nevertheless, the tables of propositions 2.45. and 2.46. give some first indications of how one could attempt to generalize thm. 2.44. at least under some additional assumptions. As it was pointed out by K. Oguiso (to whom we are indebted for this information), if one considers, for instance, a *non-smooth* polarized CY model (X, \mathbf{L}) , such that $(h^0(X, \mathbf{L}), \mathbf{L}^3) = (3, 2)$, i.e. $\Delta(X, \mathbf{L}) = 2$, having as a general member $S \in |\mathbf{L}|$ a normal surface S with at most *rational Gorenstein singularities*, $\dim Bs(|\mathbf{L}|_S) \leq 0$ and any general $C \in |\mathbf{L}|_S$ irreducible, then the assertions (5.6.) and (5.7.) from [94, pp. 423-424] remain true and X has to be a (not necessarily quasismooth) complete intersection of two hypersurfaces with multidegree $(4, 6)$ in $\mathbb{P}^5(1, 1, 1, 2, 2, 3)$. Since a Fermat hypersurface of degree 12 in $\mathbb{P}^4(1, 2, 2, 3, 4)$ has also $(h^0(\mathbf{L}), \mathbf{L}^3) = (3, 2)$ (with $\mathbf{L} = \mathcal{O}(2)$, cf. thm. 2.37. and prop. 2.45.) and satisfies the above mentioned properties, one should expect that it would “degenerate” into this c.i. of multidegree $(4, 6)$ in $\mathbb{P}^5(1, 1, 1, 2, 2, 3)$. Similar phenomena also occur for other pairs of models of the

tables of prop. 2.45. and 2.46., although there are at least three *exceptional cases*, namely those of (8), (10) and (11) of the table of prop. 2.45., which are of another nature! In these cases, a general member of $|L|$, say S , does not obey to Noether's inequality, which means, that even if we assume that $\dim Bs(|L|_S) \leq 0$ and that ω_S is invertible, S has to contain non-rational singularities, as for example *elliptic Gorenstein singularities*, comp. [98, thm. (2.6), p. 287]. (Details of the properties of such models will be discussed elsewhere.)

(ii) Using elementary number theory, we shall verify in 4.12. that, up to permutations of weights and degrees and up to different coefficients of the defining polynomials, there exist exactly 171 BP q.s.c. intersections of dimension 3 and of vanishing amplitude satisfying the assumptions of cor. 2.39. Namely 147 with codimension $k = 1$, 19 with $k = 2$, 4 with $k = 3$ and one with $k = 4$. By (2.26) and (2.28), we can deduce that the minimal delta genus for such an X with $k \in \{2, 3, 4\}$ occurs when $X = X_{(6,6)} \subset \mathbb{P}^5(1, 2, 2, 2, 2, 3)$ and $\Delta = 4$.

(iii) R. Schimmrigk studied the diagram of the "geographical placing" of the pairs $(L_X^3, [c_2]_X(L_X))$ for all 7555 combinations of $(d; \mathbf{w})$'s leading to quasismooth, well-formed hypersurfaces $X = X_d \subset \mathbb{P}^4(\mathbf{w})$ (cf. comments at the end of § 1). As it has turned out (see R. Schimmrigk: "Scaling behaviour in string theory", Bonn-TH-94-29, Preprint, December 1994), the number $[c_2]_X(L_X)$ grows like:

$$\frac{1}{24}([c_2]_X(L_X)) \sim B \cdot (L_X^3)^\beta$$

with approximative values: $B = 1,5$ and $\beta = 0,29$, which are in fact due to the arithmetical behaviour of η_X and of the pt-summands of $h^0(X, \mathcal{O}_X(\eta_X))$ in (2.20) (see also § 7). Moreover, Schimmrigk's $(L_X^3, [c_2]_X(L_X))$ -diagram (being depicted in logarithmic scales) shows that, if one ignores the 16 "special" hypersurfaces of prop. 2.45., the remaining 7539 are located within a lane region which lies far below the dotted "RR-line" $[c_2]_X(L_X) = 10(L_X^3)$. This gives an evidence in support of Wilson's conjecture [128, p. 409] on the existence of further inequalities involving L^3 and $[c_2](L)$, where L denotes an ample line bundle over an arbitrary CY-model of general type.

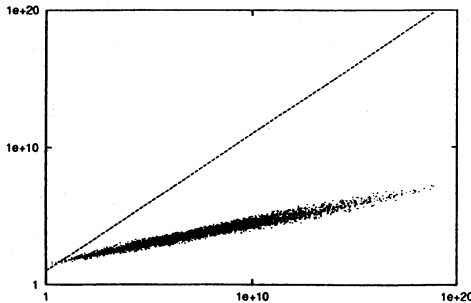

Schimmrigk's diagram



§ 3. Toric crepant resolutions of 2- and 3-dimensional Gorenstein cyclic quotient singularities

As it was mentioned in prop. 2.5. and 2.18., well-formed q.s.c. intersections have singular loci consisting of *cyclic quotient singularities (c.q.s.)* In particular, when the amplitude vanishes, the occurring c.q.s. are Gorenstein. To resolve them locally by crepant morphisms, we shall make use of the language of toric geometry as it is presented by Danilov [25], Oda [93] and Fulton [47].

Let us first review some preliminary definitions and facts and fix certain useful notations.

(i) For a lattice N of rank r , $M = \text{Hom}_{\mathbb{Z}}(N, \mathbb{Z})$ denotes its dual lattice and $N_{\mathbb{R}} := N \otimes_{\mathbb{Z}} \mathbb{R}$, $M_{\mathbb{R}} := M \otimes_{\mathbb{Z}} \mathbb{R}$ their scalar extensions to the field of real numbers. A subset σ of $N_{\mathbb{R}}$ is said to be a *strongly convex rational polyedral cone* (SCRPC, for short) if $\sigma \cap (-\sigma) = \{0\}$ and if there exist $n_1, \dots, n_{\mu} \in N$, s.t. $\sigma = \mathbb{R}_{\geq 0}n_1 + \dots + \mathbb{R}_{\geq 0}n_{\mu}$. Its *dimension* $\dim(\sigma)$ is that of the smallest \mathbb{R} -subspace $\sigma + (-\sigma) = \mathbb{R}\sigma$ of $N_{\mathbb{R}}$ containing σ and its *relative interior* $\text{int}(\sigma)$ (resp. its *relative boundary* $\partial\sigma$) is defined to be the usual interior (resp. the usual boundary) of σ regarded as a subset of the \mathbb{R} -vector space $\mathbb{R}\sigma$. Such a σ is called *simplicial* if n_1, \dots, n_{μ} are linearly independent over \mathbb{R} . The *dual cone* $\check{\sigma}$ of σ is defined by $\check{\sigma} := \{x \in M_{\mathbb{R}} \mid \langle x, y \rangle \geq 0, \forall y \in \sigma\}$ and turns out to be an r -dimensional SCRPC in $M_{\mathbb{R}}$. (Here $\langle \cdot, \cdot \rangle: M_{\mathbb{R}} \times N_{\mathbb{R}} \rightarrow \mathbb{R}$ denotes the natural \mathbb{R} -bilinear pairing). A subset τ of a SCRPC σ is called a *face* of σ (notation: $\tau \prec \sigma$) if it can be expressed as $\tau = \sigma \cap \{m_0\}^{\perp} := \{y \in \sigma \mid \langle m_0, y \rangle = 0\}$ for some $m_0 \in \check{\sigma}$.

(ii) For a μ -tuple $(n_1, \dots, n_{\mu}) \in N^{\mu}$ consisting of \mathbb{R} -linearly independent vectors, we define

$s(n_1, \dots, n_{\mu}) := \{y \in N_{\mathbb{R}} \mid y = \sum_{i=1}^{\mu} \lambda_i n_i \text{ with } \sum_{i=1}^{\mu} \lambda_i = 1 \text{ and } \lambda_1, \dots, \lambda_{\mu} \in \mathbb{R}_{\geq 0}\}$
to be the usual closed, affine simplex with vertices n_1, \dots, n_{μ} , and, for a given $s = s(n_1, \dots, n_{\mu})$, we set $\sigma(s) := \mathbb{R}_{\geq 0}n_1 + \dots + \mathbb{R}_{\geq 0}n_{\mu}$ to indicate the simplicial SCRPC arising from it after omitting of the affinity condition for its defining linear combinations.

(iii) If $\sigma \subset N_{\mathbb{R}}$ is a SCRPC, then the intersection $M \cap \check{\sigma}$ generates M as a group, is saturated, and is a finitely generated additive subsemigroup of M containing 0 , i.e. there exist $m_1, \dots, m_k \in M$, s.t. $M \cap \check{\sigma} = \mathbb{N}_0 m_1 + \dots + \mathbb{N}_0 m_k$. If $\tau \prec \sigma$ with $\tau = \sigma \cap \{m_0\}^{\perp}$, then $M \cap \check{\tau} = M \cap \check{\sigma} + \mathbb{N}_0(-m_0)$.

(iv) Let now $T_N \cong (\mathbb{C}^*)^r$ be the r -dimensional algebraic torus defined by $T_N := \text{Hom}_{\mathbb{Z}}(M, \mathbb{C}^*) = N \otimes_{\mathbb{Z}} \mathbb{C}^*$. Every $m \in M$ (resp. $n \in N$) assigns a character $e(m) : T_N \ni t \mapsto t(m) \in \mathbb{C}^*$ (resp. a 1-parameter subgroup $\gamma_n : \mathbb{C}^* \ni \lambda \mapsto \gamma_n(\lambda) \in T_N$, $\gamma_n(\lambda)(m) = \lambda^{\langle m, n \rangle}$, $\forall m \in M$) of T_N . This means that, after having chosen a \mathbb{Z} -basis $\{n_1, \dots, n_r\}$ of N and its dual basis $\{m_1, \dots, m_r\}$, we shall always get an isomorphism $T_N \ni t \mapsto (u_1(t), \dots, u_r(t)) \in (\mathbb{C}^*)^r$ for $u_j := e(m_j)$, $1 \leq j \leq r$, and that $\{u_1, \dots, u_r\}$ can therefore be considered as a coordinate system of T_N . On the other hand, for a SCRPC σ with $M \cap \check{\sigma} = \mathbb{N}_0 m_1 + \dots + \mathbb{N}_0 m_k$, we associate to the finitely generated, normal \mathbb{C} -algebra $\mathbb{C}[M \cap \check{\sigma}]$ an affine variety $U_{\sigma} := \text{Spec}(\mathbb{C}[M \cap \check{\sigma}])$, which can be written

$$U_{\sigma} = \{u : M \cap \check{\sigma} \rightarrow \mathbb{C} \mid u(0) = 1, u(m + m') = u(m)u(m'), \forall m, m' \in M \cap \check{\sigma}\}$$

with $e(m)(u) := u(m), \forall m \in M \cap \check{\sigma}$ and $\forall u \in U_\sigma$. In the analytic category, U_σ , identified with its image under $(e(m_1), \dots, e(m_k)) : U_\sigma \rightarrow \mathbb{C}^k$, can be regarded as an analytic set determined by a system of equations of the form: (monomial) = (monomial). This complex analytic structure induced on U_σ is independent of the semigroup generators $\{m_1, \dots, m_k\}$ and each polynomial function $e(m)$ on U_σ is holomorphic w.r.t. it. In particular, for $\tau \prec \sigma$, U_τ is an open subset of U_σ .

(v) A *fan* in $N \cong \mathbb{Z}^r$ is a collection Σ of SCRPCs in $N_{\mathbb{R}}$, s.t. (a) any face τ of $\sigma \in \Sigma$ belongs to Σ and (b) for $\sigma_1, \sigma_2 \in \Sigma$, the intersection $\sigma_1 \cap \sigma_2$ is a face of both σ_1 and σ_2 . The union $|\Sigma| := \cup\{\sigma | \sigma \in \Sigma\}$ is called *the support of Σ* . Furthermore, we define $\Sigma(i) := \{\sigma \in \Sigma | \dim(\sigma) = i\}$, $0 \leq i \leq r$.

If $\rho \in \Sigma(1)$, then there exists a unique primitive vector $n(\rho) \in \mathbb{N} \cap \rho$ with $\rho = \mathbb{R}_{\geq 0}n(\rho)$ and each cone $\sigma \in \Sigma$ can be therefore written as

$$\sigma = \sum_{\rho \in \Sigma(1), \rho \prec \sigma} \mathbb{R}_{\geq 0}n(\rho).$$

The set $Sk^1(\sigma) := \{n(\rho) | \rho \in \Sigma(1), \rho \prec \sigma\}$ is called *the first skeleton of σ* . *The toric variety associated to a fan (N, Σ)* is the identification space

$$Z(N, \Sigma) := ((\coprod_{\sigma \in \Sigma} U_\sigma) / \sim) \text{ with } U_{\sigma_1} \ni u_1 \sim u_2 \in U_{\sigma_2} : \iff$$

$$(\exists \tau \prec \sigma_1 \cap \sigma_2 : u_i \in U_\tau \subset U_{\sigma_i}, \text{ for } i = 1, 2, \text{ and } u_1 = u_2 \text{ within } U_\tau).$$

$Z(N, \Sigma)$ admits a canonical T_N -action, which extends the group multiplication of $T_N = U_{\{0\}} : T_N \times Z(N, \Sigma) \ni (t, u) \mapsto t \cdot u \in Z(N, \Sigma)$,

where, for $u \in U_\sigma$, $(t \cdot u)(m) := t(m) \cdot u(m)$, $\forall m \in M \cap \check{\sigma}$.

(vi) If we denote by $\text{orb}(\sigma)$ (resp. $V(\sigma) := \overline{\text{orb}(\sigma)}$) the orbit (resp. the closure of the orbit) of $\sigma \in \Sigma$ under this action, then

$$\begin{aligned} \Sigma \ni \sigma \mapsto \text{orb}(\sigma) = \{u : M \cap \sigma^\perp \rightarrow \mathbb{C}^* | u \text{ group homomorphism} \\ \in \{T_N - \text{orbits in } Z(N, \Sigma)\} \end{aligned}$$

establishes an 1-1 correspondence. The T_N -orbits have the following properties:

- (a) $\text{orb}(\{0\}) = U_{\{0\}} = T_N$ and $\dim(\text{orb}(\sigma)) = r - \dim(\sigma)$, $\forall \sigma \in \Sigma$.
- (b) $\tau \prec \sigma \iff \text{orb}(\sigma) \subset V(\tau)$.
- (c) For $\sigma \in \Sigma$, $\text{orb}(\sigma)$ is the unique closed T_N -orbit in U_σ and $U_\sigma = \coprod\{\text{orb}(\tau) | \tau \prec \sigma\}$.
- (d) For $\tau \in \Sigma$, we have $V(\tau) = \coprod\{\text{orb}(\sigma) | \sigma \in \Sigma, \tau \prec \sigma\}$.
- (e) For $\tau \in \Sigma$, $V(\tau) = Z(N(\tau), \text{Star}(\tau))$ is itself a toric variety w.r.t. $N(\tau) := N/\mathbb{Z}(\tau \cap N)$, $\text{Star}(\tau) := \{\bar{\sigma} | \sigma \in \Sigma, \tau \prec \sigma\}$, where $\bar{\sigma} := (\sigma + \mathbb{R}\tau)/\mathbb{R}\tau$ denotes the image of σ in $N(\tau)_{\mathbb{R}} = N_{\mathbb{R}}/\mathbb{R}\tau$.

(vii) Let $Z(N, \Sigma)$ be the toric variety associated to a fan Σ and $N \cong \mathbb{Z}^r$. Then:

- (a) for $\sigma \in \Sigma$, U_σ is nonsingular $\iff (\exists \mathbb{Z}$ -basis $\{n_1, \dots, n_r\}$ of N and $k \leq r$ with $\sigma = \sum_{i=1}^k \mathbb{R}_{\geq 0}n_i)$ and $Z(N, \Sigma)$ is nonsingular $\iff (U_\sigma$ is nonsingular, $\forall \sigma \in \Sigma)$.
- (b) $Z(N, \Sigma)$ is compact $\iff \Sigma$ is finite and $|\Sigma| = N_{\mathbb{R}}$.

(viii) A *map of fans* $\varphi : (N', \Sigma') \rightarrow (N, \Sigma)$ is a \mathbb{Z} -linear homomorphism $\varphi : N' \rightarrow N$ whose scalar extension $\varphi : N'_{\mathbb{R}} \rightarrow N_{\mathbb{R}}$ satisfies the property: $(\forall \sigma' \in \Sigma', \exists \sigma \in \Sigma : \varphi(\sigma') \subset \sigma)$. Such a φ induces an holomorphic map $\varphi_* : Z(N', \Sigma') \rightarrow Z(N, \Sigma)$ which is equivariant w.r.t. the action of $T_{N'}$ and T_N . Moreover, φ_* is proper

$\iff (\forall \sigma \in \Sigma, \Sigma'_\sigma := \{\sigma' \in \Sigma' \mid \varphi(\sigma') \subset \sigma\}$ is finite and $\varphi^{-1}(\sigma) = |\Sigma'_\sigma|$). In particular, if $N' = N$, $\varphi = \text{id}$ and Σ' is a locally finite nonsingular subdivision of Σ , then id_* is proper and birational and gives an equivariant desingularization of $Z(N, \Sigma)$.

(ix) For the group $T_N \text{Div}(Z)$ of Weil divisors on a toric variety $Z = Z(N, \Sigma)$ we have $T_N \text{Div}(Z) \cong \bigoplus_{\rho \in \Sigma(1)} \mathbb{Z}V(\rho)$. (For another approach via support functions see [93, §2.1].)

Let us now come back to our c.q.s. and see how are they describable in terms of the above given toric glossary (i)-(ix). Suppose that $r \geq 2$ and $G \subset GL(r, \mathbb{C})$ is a finite cyclic group of order l containing no pseudoreflections and being generated by $\text{diag}(\zeta_l^{\alpha_1}, \dots, \zeta_l^{\alpha_r})$, for suitable integers $0 \leq \alpha_1, \dots, \alpha_r < l$. If $(\mathbb{C}^r/G, [\mathbf{0}])$ is the germ of the corresponding quotient singularity, its underlying space \mathbb{C}^r/G can be identified with a toric variety $Z(N_G, \Sigma_0)$ of type $(l; \alpha_1, \dots, \alpha_r)$ as follows: $T_{N_G} := (\mathbb{C}^*)^r/G$ is an r -dimensional algebraic torus with 1-parameter group N_G and with group of characters $M_G = \text{Hom}_{\mathbb{Z}}(N_G, \mathbb{Z})$. Let $\{e_1 = (1, \dots, 0), \dots, e_r = (0, \dots, 1)\}$ be the standard basis of \mathbb{Z}^r . Then

$$N_G = N_0 + \sum_{j=1}^{l-1} \mathbb{Z} \left(\frac{[j\alpha_1]_l}{l}, \dots, \frac{[j\alpha_r]_l}{l} \right) \quad \text{with} \quad N_0 := \sum_{i=1}^r \mathbb{Z}e_i \quad \text{and}$$

$$M_G = \bigcap_{j=1}^{l-1} M_j \quad \text{with} \quad M_j := \{(m_1, \dots, m_r) \in \mathbb{Z}^r \mid \sum_{i=1}^r m_i [j\alpha_i]_l \equiv 0 \pmod{l}\}$$

$$\forall j, 1 \leq j \leq l-1.$$

Defining $\sigma_0 := \sum_{i=1}^r \mathbb{R}_{\geq 0}e_i$, $\Sigma_0 := \{\tau \mid \tau \prec \sigma_0\}$, and using the exact sequence

$$0 \rightarrow G \cong N_G/N_0 \rightarrow T_{N_0} \rightarrow T_{N_G} \rightarrow 0$$

we get as projection map: $\mathbb{C}^r = Z(N_0, \Sigma_0) \rightarrow Z(N_G, \Sigma_0) = \mathbb{C}^r/G$.

Proposition 3.1. *For $Z(N_G, \Sigma_0)$ the following conditions are equivalent:*

- (i) $Z(N_G, \Sigma_0)$ is Gorenstein.
- (ii) $\omega_{Z(N_G, \Sigma_0)}$ is trivial.
- (iii) $\exists ! m_0 \in M : \langle m_0, e_i \rangle = 1, \forall i, 1 \leq i \leq r$.

Proof. It follows from [98, footnote of p. 294] and Ishida's criteria [93, p. 126]. \square

If $\varphi = \text{id}_* : Z(N_G, \Sigma'_0) \rightarrow Z(N_G, \Sigma_0) = \mathbb{C}^r/G$ is a T_{N_G} -equivariant desingularization of $Z(N_G, \Sigma_0)$, then a cone $\mathbb{R}_{\geq 0}n(\rho')$, $\rho' \in \Sigma'_0(1)$, determines a prime divisor $D_{n(\rho')} := V(\mathbb{R}_{\geq 0}n(\rho')) = Z(\text{Star}(\mathbb{R}_{\geq 0}n(\rho')))$ on $Z(N_G, \Sigma'_0)$. So we have an 1-1 correspondence:

$$\{\text{exceptional prime divisors w.r.t. } \pi\} \longleftrightarrow \cup \{Sk^1(\sigma') \mid \sigma' \in \Sigma'_0\} \setminus \{e_1, \dots, e_r\}.$$

D_{e_i} corresponds to the strict transform of $\{(z_1, \dots, z_r) \in \mathbb{C}^r \mid z_i = 0\}/G$ w.r.t. π , $\forall i, 1 \leq i \leq r$.

Proposition 3.2. ([86], [101] (a)) A T_{N_G} -equivariant resolution $\pi : Z(N_G, \Sigma'_0) \rightarrow Z(N_G, \Sigma_0) = \mathbb{C}^r/G$ of a Gorenstein c.q.s. $Z(N_G, \Sigma_0)$ is crepant if and only if

$$\cup\{Sk^1(\sigma')|\sigma' \in \Sigma'_0\} \subset \mathcal{H} := \{(x_1, \dots, x_r) \in \mathbb{R}^r \mid \sum_{i=1}^r x_i = 1\}.$$

In this case we get $e(Z(N_G, \Sigma'_0)) = |G|$.

Proof. Let $\sigma' \in \Sigma'_0$ and $\varphi \in H^0(U'_{\sigma', \omega_{Z(N_G, \Sigma'_0)}}|_{U'_{\sigma'}})$ be $\varphi = f du'_1 \wedge \dots \wedge du'_r$, w.r.t. local coordinates u'_1, \dots, u'_r of $U'_{\sigma'}$. Then the zero order of f along any exceptional prime divisor $D_{n(\rho')}$, $\rho' \in \Sigma'_0(1)$, $\rho' \prec \sigma'$, equals $(\text{trace}(n(\rho'))) - 1$. So π is crepant if and only if the total union $\cup\{Sk^1(\sigma')|\sigma' \in \Sigma'_0(r)\}$ lies in the hyperplane \mathcal{H} . Moreover, $e(Z(N_G, \Sigma'_0)) = \sharp(\Sigma'_0(r))$, which is equal to the multiplicity $[N_G : N_0] = |G|$ of σ_0 , because $\sigma_0 = \cup\{\sigma'|\sigma' \in \Sigma'_0(r)\}$. \square

For $r \geq 4$ it is not always possible to construct such crepant resolutions. Nevertheless, in dimension 2 and 3, relatively simple principles of the corresponding lattice geometry lead to the desired constructions.

Proposition 3.3. For $r = 2$ and $Z(N_G, \Sigma_0)$ a Gorenstein c.q.s. of type $(l; \alpha_1, \alpha_2)$, there is a unique crepant desingularization $\pi : Z(N_G, \Sigma'_0) \rightarrow Z(N_G, \Sigma_0)$ with $\Sigma'_0 = \{\{\mathbb{R}_{\geq 0}(\frac{[j\alpha_1]_l}{l}, \frac{[j\alpha_2]_l}{l}) \mid 1 \leq j \leq l-1\}, \mathbb{R}_{\geq 0}e_1, \mathbb{R}_{\geq 0}e_2 \text{ and their faces}\}$, being provided with $l-1$ exceptional prime divisors $\cong \mathbb{P}^1$, which compose a Hirzebruch-Jung string.

Let now $r = 3$ and $Z(N_G, \Sigma_0) = \mathbb{C}^3/G$ be of type $(l; \alpha_1, \alpha_2, \alpha_3)$. We define $s_0 := s(e_1, e_2, e_3)$ and

$$\Phi_G := \left\{ \left(\frac{[j\alpha_1]_l}{l}, \frac{[j\alpha_2]_l}{l}, \frac{[j\alpha_3]_l}{l} \right) \mid \sum_{i=1}^3 [j\alpha_i]_l = l, 1 \leq j \leq l-1 \right\}$$

(If $G \subset SL(3, \mathbb{C})$, we can always assume, up to a generator change, that $\alpha_1 + \alpha_2 + \alpha_3 = l$.)

Proposition 3.4. All toric crepant resolutions of a Gorenstein c.q.s. $Z(N_G, \Sigma_0) = \mathbb{C}^3/G$ are of the form $\pi : Z(N_G, \Sigma'_0(\mathcal{S})) \rightarrow Z(N_G, \Sigma_0)$, where \mathcal{S} denotes a triangulation of $\Sigma_0 \cap \mathcal{H} = \{\tau \cap \mathcal{H} \mid \tau \prec \sigma_0\}$ with $s_0 \cap N_G = \Phi_G \coprod \{e_1, e_2, e_3\}$ as the sets of its vertices and $\Sigma'_0(\mathcal{S}) = \{\{0\}, \{\sigma(s) \mid s \in \mathcal{S}\}\}$. Moreover, they fulfill the following properties:

(i)

$$(3.1) \quad \sharp(\text{int}(s_0) \cap N_G) = \frac{1}{2} \left(l - \sum_{i=1}^3 \gcd(\alpha_i, l) \right) + 1$$

(ii) Let $D_n := V(\sigma(\{n\}))$ denote the prime divisor corresponding to an $n \in s_0 \cap N_G$.

(a) We have $\{\text{exc. pr. divisors w.r.t. } \pi\} = \cup\{D_n \mid n \in \Phi_G\}$.

(b) If $n \in \text{int}(s_0) \cap N_G$, then D_n is a rational surface coming from finitely many $T_{N_G(\sigma(\{n\}))}$ -equivariant blow-ups either of \mathbb{P}^2 or of a Hirzebruch surface

$\mathbb{F}_a := \mathbb{P}(\mathcal{O}_{\mathbb{P}^1} \oplus \mathcal{O}_{\mathbb{P}^1}(a))$, $a \geq 0$.

(c) If $\partial s_0 \cap \Phi_G$ is non-empty and n one of its members lying on $s(e_{i_1}, e_{i_2})$, where $1 \leq i_1, i_2 \leq 3$, $i_1 \neq i_2$ and $\{i_3\} = \{1, 2, 3\} \setminus \{i_1, i_2\}$, then D_n represents a ruled fibration over the i_3 -axis. Its fibers over the ‘‘punctured’’ i_3 -axis are isomorphic to \mathbb{P}^1 .

Proof. That the T_{N_G} -equivariant desingularizations of $Z(N_G, \Sigma_0)$ are parametrized by the above triangulations follows from [101 (a), prop. 2, p. 528].

(i) It is easy to verify that $\#\Phi_G = \frac{1}{2}(l + \sum_{i=1}^3 \gcd(\alpha_i, l)) - 2$ and $\#(\partial s_0 \cap \Phi_G) = \sum_{i=1}^3 \gcd(\alpha_i, l) - 3$.

(ii) (a) and (c) are clear from the construction. (b) follows from [93, thm. 1.28]. \square

Remarks 3.5.

(i) To each 1-simplex $s(n_1, n_2)$ of an \mathcal{S} corresponds a curve $\mathcal{C}(n_1, n_2) := V(\sigma(s(n_1, n_2)))$. $\mathcal{C}(n_1, n_2)$ is compact $\iff \text{int}(s(n_1, n_2)) \subset \text{int}(s_0)$. In this case $\mathcal{C}(n_1, n_2) \cong \mathbb{P}^1$.

(ii) If n is as in 3.4. (ii) (c), $\text{Spl}^1(\mathcal{S})(n)$ denotes all 1-simplices of \mathcal{S} which are connected with n having their second vertex in $\Phi_G \setminus \{n\}$ and $b(n) := \#(\text{Spl}^1(\mathcal{S})(n))$, then the fiber of $D_n \rightarrow \{i_3\text{-axis}\}$ over the zero point consists of a tree-configuration of $b(n)$ rational curves $\{\mathcal{C}(n, n_1), \dots, \mathcal{C}(n, n_{b(n)})\}$ with

$$\mathcal{C}(n, n_{t_1}) \cap \mathcal{C}(n, n_{t_2}) = \begin{cases} \{\text{a point}\}, & \text{for } |t_1 - t_2| = 1, 1 \leq t_1, t_2 \leq b(n) \\ \emptyset, & \text{otherwise} \end{cases}$$

where $\text{Spl}^1(\mathcal{S})(n) = \{s(n, n_t) | 1 \leq t \leq b(n)\}$.

Proposition 3.6. Let $Z(N_G, \Sigma_0) = \mathbb{C}^3/G$ be a Gorenstein c.q.s. and $Z(N_G, \Sigma'_0(\mathcal{S})) \rightarrow Z(N_G, \Sigma_0)$ be a crepant resolution w.r.t. \mathcal{S} .

(i) For three distinct vertices n_1, n_2, n_3 of \mathcal{S} we have $(D_{n_1} \cdot D_{n_2} \cdot D_{n_3}) \neq 0 \iff s(n_1, n_2, n_3)$ is a 2-simplex of \mathcal{S} . In this case $(D_{n_1} \cdot D_{n_2} \cdot D_{n_3}) = 1$.

(ii) If $n_1, n_2 \in s_0$, $s(n_1, n_2)$ is an 1-simplex of \mathcal{S} , but not both n_1 and n_2 belong to the same face of ∂s_0 , then there exist exactly two vertices n_3, n_4 of \mathcal{S} , such that $s(n_1, n_2, n_3)$ and $s(n_1, n_2, n_4)$ are 2-simplices of \mathcal{S} , and the corresponding intersection numbers are related by

$$(3.2) \quad (D_{n_1}^2 \cdot D_{n_2})n_1 + (D_{n_1} \cdot D_{n_2}^2)n_2 + n_3 + n_4 = 0$$

(iii) If $n \in \text{int}(s_0)$ is a vertex of \mathcal{S} , then:

$$(3.3) \quad D_n^3 = 12 - \#(\text{Star}(\mathbb{R}_{\geq 0}n)(2))$$

Proof. For (i) and (ii) apply the general techniques of [47, § 5].

(iii) Noether’s formula gives $\chi(D_n, \mathcal{O}_{D_n}) = 1 \implies \omega_{D_n}^2 = 12 - e(D_n)$. Since $\omega_{Z(N_G, \Sigma'_0(\mathcal{S}))} \cong \mathcal{O}_{Z(N_G, \Sigma'_0(\mathcal{S}))}$, we have $\omega_{D_n}^2 = D_n^3$ by adjunction. On the other hand

the topological Euler-Poincaré characteristic is nothing but $e(D_n) = e(V(\sigma(\{n\}))) = e(V(\mathbb{R}_{\geq 0}n)) = e(\text{Star}(\mathbb{R}_{\geq 0}n)) = \#(\text{Star}(\mathbb{R}_{\geq 0}n)(2))$ (cf. [47, p. 59]). \square

Definition 3.7. Let $Z(N, \Sigma)$ be a 3-dimensional nonsingular toric variety, associated to a fan Σ (w.r.t. $N \cong \mathbb{Z}^3$), $\{n_1, n_2, n_3\}$, $\{n_1, n_2, n_4\}$ two \mathbb{Z} -bases of N and $\sigma_1, \sigma_2 \in \Sigma(3)$ two cones $\sigma_1 = \mathbb{R}_{\geq 0}n_1 + \mathbb{R}_{\geq 0}n_2 + \mathbb{R}_{\geq 0}n_3$, $\sigma_2 = \mathbb{R}_{\geq 0}n_1 + \mathbb{R}_{\geq 0}n_2 + \mathbb{R}_{\geq 0}n_4$ adjacent along $\tau_{1,2} = \mathbb{R}_{\geq 0}n_1 + \mathbb{R}_{\geq 0}n_2$. If n_1, n_2, n_3 are coplanar and $n_1 + n_2 = n_3 + n_4$, then $\sigma_3 = \mathbb{R}_{\geq 0}n_1 + \mathbb{R}_{\geq 0}n_3 + \mathbb{R}_{\geq 0}n_4$, $\sigma_4 = \mathbb{R}_{\geq 0}n_2 + \mathbb{R}_{\geq 0}n_3 + \mathbb{R}_{\geq 0}n_4$ are adjacent along the 2-dimensional cone $\tau_{3,4} = \mathbb{R}_{\geq 0}n_3 + \mathbb{R}_{\geq 0}n_4$ and $Z(N, \tilde{\Sigma})$, with $\tilde{\Sigma} := (\Sigma \setminus \{\sigma_1, \sigma_2, \tau_{1,2}\}) \cup \{\sigma_3, \sigma_4, \tau_{3,4}\}$, is a nonsingular toric variety. In this case, $\tilde{\Sigma}$ is called *elementary transformation* of Σ w.r.t. σ_1, σ_2 and $\tau_{1,2}$. (See Fig. 1.)

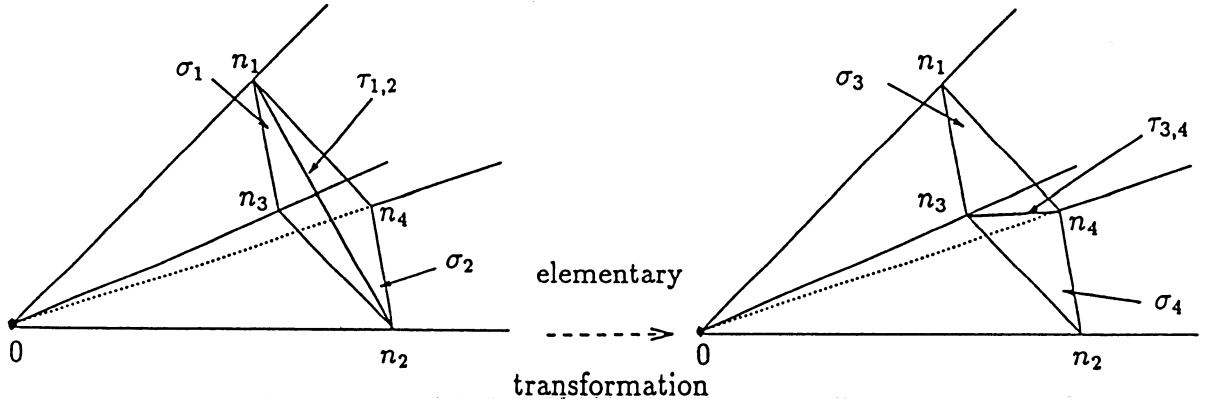

Fig. 1

Proposition 3.8. Let Σ_1, Σ_2 be two nonsingular fans in $N \cong \mathbb{Z}^3$ with $|\Sigma_1| = |\Sigma_2|$. If we assume the existence of an m_0 in $M = \text{Hom}_{\mathbb{Z}}(N, \mathbb{Z})$, for which $\langle m_0, n(\rho_1) \rangle = \langle m_0, n(\rho_2) \rangle = 1$ for all $\rho_1 \in \Sigma_1(1)$ and all $\rho_2 \in \Sigma_2(1)$, then Σ_2 is obtained from Σ_1 by a finite succession of elementary transformations.

Proof. See Danilov [26, prop. 2] or Oda [93, prop. 1.30. (ii)]. \square

Corollary 3.9. The fans $\Sigma'_0(\mathcal{S}_i)$, $i = 1, 2$, which correspond to two crepant resolutions $\pi_i : Z(N_G, \Sigma'_0(\mathcal{S}_i)) \rightarrow Z(N_G, \Sigma_0)$, $i = 1, 2$, of a Gorenstein 3-dimensional cyclic quotient singularity, differ from each other by finitely many elementary transformations.

Proof. Obvious by propositions 3.2. and 3.8. \square



§ 4. Global toroidal crepant desingularizations

Let $\mathbf{w} = (w_1, \dots, w_m)$ be a system of weights, $\mathbf{d} = (d_1, \dots, d_k) \in \mathbb{N}^k$, and

$$X = X_{\mathbf{d}} = \{[z_1, \dots, z_m] \in \mathbb{P}^{m-1}(\mathbf{w}) \mid f_1(z_1, \dots, z_m) = \dots = f_k(z_1, \dots, z_m) = 0\}$$

a well-formed, well-stratified q.s.c.i. of dimension 3 (i.e. $m-k=4$) with $\text{am}(X) = 0$ and nondegenerate 1-dimensional singular strata (cf. 2.32). Using the notations of §2, we define:

$$\begin{aligned} \Gamma_0 &:= \{I \subset \{1, \dots, m\} : |I| = 3 + \mathcal{V}(I), c_I > 1 \text{ and } c_{I'} = 1, \forall I', I' \subsetneq I\}, \\ \hat{\Gamma}_0 &:= \{I \subset \{1, \dots, m\} : |I| = 3 + \mathcal{V}(I) \text{ with } c_I > 1, c_{I \setminus \{i\}} > 1 \text{ for at least one} \\ &\quad i \in I \text{ and } c_I > c_{I \setminus \{i\}} \text{ for all that i's satisfying this property}\}, \end{aligned}$$

$$\text{and } \Gamma_1 := \{I \subset \{1, \dots, m\} : |I| = 2 + \mathcal{V}(I) \text{ and } c_I > 1\}.$$

Since X is normal and well-formed, we have $\text{codim}_X(\text{Sing}(X)) \geq 2$, and $\text{Sing}(X)$ can therefore have at most 1-dimensional components. We write $\text{Sing}(X)$ as the union of 0- and 1-dimensional singular strata

$$(4.1) \quad \text{Sing}(X) = \text{SSt}^0(X) \amalg \text{SSt}^1(X)$$

where $\text{SSt}^\rho(X) := \cup\{X(I) \mid I \in \Gamma_\rho\}$, $\rho = 0, 1$ (cf. prop. 2.18). Furthermore, we define $\text{INP}(X) := \cup\{X(I) \mid I \in \hat{\Gamma}_0\}$. Without loss of generality, we shall treat here only the case in which none of the above strata is empty. We first fix an enumeration $\Gamma_1 = \{I_1, \dots, I_\kappa\}$ of the index sets of Γ_1 . Each $C_j := X(I_j)$ is an irreducible smooth curve defined by a non-well formed 1-dimensional complete intersection in \mathbb{P}_{I_j} and

$$(4.2) \quad \text{SSt}^1(X) = \{C_j \mid 1 \leq j \leq \kappa\}$$

In addition, we introduce the enumerations

$$(4.3) \quad \{t_1^j, \dots, t_{m-|I_j|}^j\} := \{1, \dots, m\} \setminus I_j$$

$$(4.4) \quad \{s_1^j, \dots, s_{k-\mathcal{V}(I_j)}^j\} := \{\text{a fixed set of indices from } \{1, \dots, k\} \text{ corresponding to an} \\ \text{enumeration of polynomials whose restrictions on } \mathbb{P}_{I_j} \text{ constitute} \\ \text{a minimal set of generators of the ideal of } C_j = X(I_j)\}$$

to be used in the following:

Lemma 4.1. For the curve C_j and any point $Q \in C_j \setminus \text{INP}(X)$ there exist integers l_{C_j} and $\alpha_1^{(C_j)}, \alpha_2^{(C_j)} \geq 1$ with $\alpha_1^{(C_j)} + \alpha_2^{(C_j)} = l_{C_j}$, depending on the weights with indices in I_j and on the defining polynomials of X , such that:

(i) the germ (X, Q) of X at Q is isomorphic to

$$(4.5) \quad (X, Q) \cong (\mathbb{C}^2 / G_{C_j} \times \mathbb{C}, [0] \times \{0\})$$

where $(\mathbb{C}^2 / G_{C_j}, [0])$ is a c.q.s. of type $(l_{C_j}; \alpha_1^{(C_j)}, \alpha_2^{(C_j)})$, and
(ii) X near C_j looks like:

$$(4.6) \quad (X, C_j) \cong ((\mathcal{O}_{C_j}(\alpha_1^{(C_j)}) \oplus \mathcal{O}_{C_j}(\alpha_2^{(C_j)})) / G_{C_j}, C_j)$$

Proof. (i) Since X is well-stratified and $Q \notin \text{INP}(X)$ (i.e. it is not possible for Q to contain more than $2 + \mathcal{V}(I_j)$ coordinates equal to zero), we have:

$$\text{rank} \left(\frac{\partial(f_{s_1^j}|_{C_j}, \dots, f_{s_{k-\mathcal{V}(I_j)}^j}|_{C_j})}{\partial(z_{t_1^j}, \dots, z_{t_{m-|I_j|}^j})} \Big|_Q \right) = k - \mathcal{V}(I_j) \quad \text{and}$$

$$\text{rank} \left(\frac{\partial(f_1, \dots, f_k)}{\partial(z_1, \dots, z_m)} \Big|_Q \right) = k.$$

Thus, by implicit function theorem, a local chart of the V -variety X centered at Q will have as coordinates $z_{q_1^j}, z_{q_2^j}$, where $\{q_1^j, q_2^j\} \subset I_j$, together with a third one $z_{q_3^j}$ expressing the restriction on C_j ($q_3^j \in \{t_1^j, \dots, t_{m-|I_j|}^j\}$). Note that the complex plane determined by $z_{q_1^j}, z_{q_2^j}$ is equipped with the action

$$(z_{q_1^j}, z_{q_2^j}) \longmapsto (\zeta_{c_{I_j}}^{[w_{q_1^j}]_{c_{I_j}}} z_{q_1^j}, \zeta_{c_{I_j}}^{[w_{q_2^j}]_{c_{I_j}}} z_{q_2^j}).$$

We end the proof just by setting $l_{C_j} := c_{I_j} = c(\mathbf{w}, I_j) = \gcd(w_{t_1^j}, \dots, w_{t_{m-|I_j|}^j})$, $\alpha_1^{(C_j)} := [w_{q_1^j}]_{c_{I_j}}$, $\alpha_2^{(C_j)} := [w_{q_2^j}]_{c_{I_j}}$, and taking into account that $\text{am}(X) = 0$.

(ii) We can use the above description or, alternatively, apply the tubular neighbourhood theorem to the affine quasicones over C_j and X . For the punctured quasicones we have $(CN^*(X), CN^*(C_j)) \cong (CN^*(C_j) \times \mathbb{C}^2 / G_{C_j}, CN^*(C_j))$. Letting \mathbb{C}^* act on them in the usual way (cf. 2.11.) we get (4.6). \square

Let us now give enumerations to the points of the singular locus of X . We set:

$$(4.7) \quad \text{SSt}^0(X) = \{P_i | 1 \leq i \leq \lambda\} \quad \text{and}$$

$$(4.8) \quad \text{INP}(X) = \{Q_\iota | 1 \leq \iota \leq \mu\} \quad \text{as well as}$$

$$(4.9) \quad \text{INP}(X) \cap C_j = \{Q_{\nu_j}^{(j)} | 1 \leq \nu_j \leq \xi_j\}, \quad 1 \leq j \leq \kappa$$

to indicate an enumeration of the points of $\text{INP}(X)$ sitting on C_j . It should be mentioned here that $\max\{\xi_j | 1 \leq j \leq \kappa\} \leq \mu \leq \sum_{j=1}^{\kappa} \xi_j$, because (for $\kappa \geq 2$) it may happen that there are indices $1 \leq j, j' \leq \kappa, j \neq j'$, such that $Q_\iota = Q_{\nu_j}^{(j)} = Q_{\nu_{j'}}^{(j')}$, for certain $1 \leq \iota \leq \mu$ and $1 \leq \nu_j \leq \xi_j, 1 \leq \nu_{j'} \leq \xi_{j'}$. (This is exactly the case, in which C_j and $C_{j'}$ have at least one intersection point.)

Lemma 4.2. *For any $P_i \in X(I), I \in \Gamma_0$, there exist integers l_{P_i} and $\alpha_1^{(P_i)}, \alpha_2^{(P_i)}, \alpha_3^{(P_i)} \geq 1$ with $\alpha_1^{(P_i)} + \alpha_2^{(P_i)} + \alpha_3^{(P_i)} = l_{P_i}$, such that*

$$(4.10) \quad (X, P_i) \cong (\mathbb{C}^3 / G_{P_i}, [\mathbf{0}])$$

i.e. the germ of X at P_i is isomorphic to that of a c.q.s. of type $(l_{P_i}; \alpha_1^{(P_i)}, \alpha_2^{(P_i)}, \alpha_3^{(P_i)})$. (The same holds true if we consider a Q_ι instead of P_i).

Proof. Exactly as in the proof of 4.1. one finds indices $\{q_1, q_2, q_3\} \subset I$, such that $z_{q_1}, z_{q_2}, z_{q_3}$ represent local coordinates of X centered at P_i with respect to the action:

$$(z_{q_1}, z_{q_2}, z_{q_3}) \longmapsto (\zeta_{c_I}^{[w_{q_1}]_{c_I}} z_{q_1}, \zeta_{c_I}^{[w_{q_2}]_{c_I}} z_{q_2}, \zeta_{c_I}^{[w_{q_3}]_{c_I}} z_{q_3}).$$

Since the acting cyclic group lies in $SL(3, \mathbb{C})$, we set $l_{P_i} := c_I$ and make use of the “normalization” of the exponents

$$(\alpha_1^{(P_i)}, \alpha_2^{(P_i)}, \alpha_3^{(P_i)}) := \begin{cases} ([w_{q_1}]_{c_I}, [w_{q_2}]_{c_I}, [w_{q_3}]_{c_I}), & \text{if } \sum_{\rho=1}^3 [w_{q_\rho}]_{c_I} = c_I \\ (c_I - [w_{q_1}]_{c_I}, c_I - [w_{q_2}]_{c_I}, c_I - [w_{q_3}]_{c_I}), & \text{if } \sum_{\rho=1}^3 [w_{q_\rho}]_{c_I} = 2c_I \end{cases}$$

□

The points of $\text{SSt}^0(X)$ are the *isolated points* of $\text{Sing}(X)$. The points of $\text{INP}(X)$ will be called *individual*. The justification of the choice of this name comes from the fact, that for a $Q_{\nu_j}^{(j)} \in \text{INP}(X) \cap C_j$, the group $G_{Q_{\nu_j}^{(j)}}$ has order strictly bigger than that one of the group G_{C_j} . The union $\text{SSt}^0(X) \amalg \text{INP}(X)$ of isolated and individual points of $\text{Sing}(X)$ constitutes the set of the so called *dissident points* in Reid’s terminology (see [98, Cor. 1.14., p. 281]), i.e. the set of points of the threefold X which are not of *compound Du Val type*. In other words, the *compound Du Val locus*, in our case, is composed of the points of $\text{SSt}^1(X) \setminus \text{INP}(X)$, and each point $Q \in C_j \setminus \text{INP}(X)$ is by lemma 4.1. of type $cA_{l_{C_j}-1}$.

Let us now consider appropriate open neighbourhoods \mathcal{U}_{P_i} , resp. \mathcal{U}_{Q_ι} of P_i , resp. of $Q_\iota, 1 \leq i \leq \lambda, 1 \leq \iota \leq \mu$, such that $\mathcal{U}_{P_i} \cong Z(N_{G_{P_i}}, \Sigma_0) = \mathbb{C}^3 / G_{P_i}$ and $\mathcal{U}_{Q_\iota} \cong Z(N_{G_{Q_\iota}}, \Sigma_0) = \mathbb{C}^3 / G_{Q_\iota}$ respectively. Since $Q_\iota = Q_{\nu_j}^{(j)}$ for some $1 \leq \nu_j \leq \xi_j, 1 \leq j \leq \kappa$, we can take a tubular neighbourhood \mathcal{U}_{C_j} of C_j , such that

$$(4.11) \quad \mathcal{U}_{C_j} \cap \mathcal{U}_{Q_{\nu_j}^{(j)}} \cong V(\tau^{(j)}) = Z(N_{G_{Q_{\nu_j}^{(j)}}}(\tau^{(j)}), \text{Star}(\tau^{(j)}))$$

with $\tau^{(j)} = \mathbb{R}_{\geq 0} e_{v_1^{(j)}} + \mathbb{R}_{\geq 0} e_{v_2^{(j)}}$, $\{v_1^{(j)}, v_2^{(j)}\} \in \{\{1, 2\}, \{2, 3\}, \{3, 1\}\}$.

Fig. 2 shows these neighbourhoods of two curves of $\text{SSt}^1(X)$ having an individual intersection point.

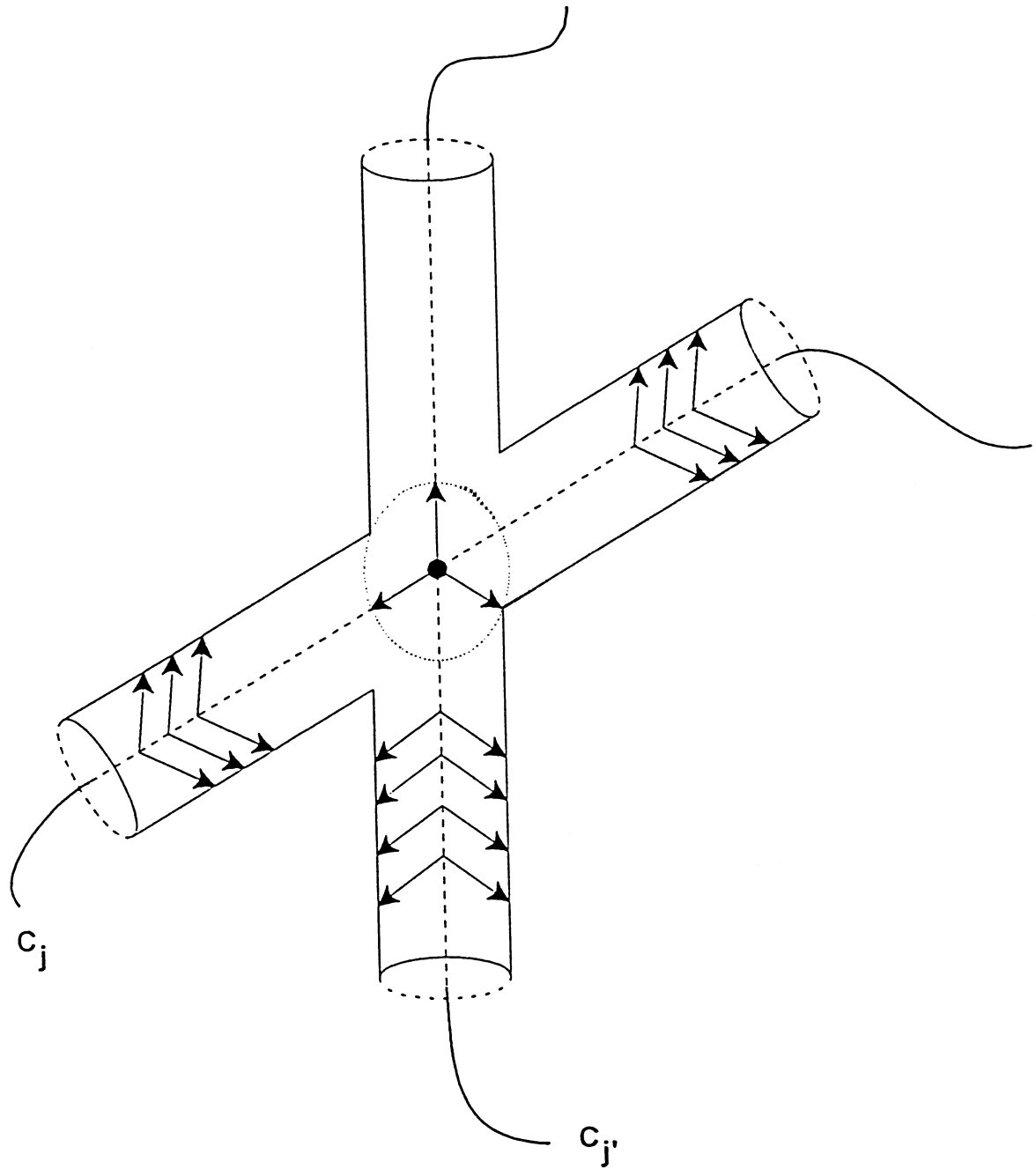

Fig. 2

Using prop. 3.4 we construct toric crepant resolutions

$$(4.12) \quad \pi_{P_i}(\mathcal{S}_{P_i}) : (Z(N_{G_{P_i}}, \Sigma'_0(\mathcal{S}_{P_i})), \mathcal{E}_{P_i}) \rightarrow (Z(N_{G_{P_i}}, \Sigma_0), P_i)$$

$$(4.13) \quad \pi_{Q_i}(\mathcal{S}_{Q_i}) : (Z(N_{G_{Q_i}}, \Sigma'_0(\mathcal{S}_{Q_i})), \mathcal{E}_{Q_i}) \rightarrow (Z(N_{G_{Q_i}}, \Sigma_0), Q_i)$$

with $\mathcal{E}_{P_i} := \{D_n^{(P_i)} | n \in \text{int}(s_0) \cap N_{G_{P_i}}\}$, $\mathcal{E}_{Q_i} := \{D_n^{(Q_i)} | n \in \text{int}(s_0) \cap N_{G_{Q_i}}\}$. (All the above divisors are assumed to be endowed with the *reduced* space structure.) Analogously, we construct uniquely determined crepant resolutions

$$(4.14) \quad \pi_{C_j} : Z(N_{G_{C_j}}, \Sigma'_0) \times C_j \rightarrow \mathcal{U}_{C_j} \cong Z(N_{G_{C_j}}, \Sigma_0) \times C_j$$

by applying prop. 3.3. along the normal sheaf $\mathcal{N}_{C_j/X}$ of C_j in X . (4.11) give rise to the compatibility conditions

$$(4.15) \quad \pi_{C_j}|_{\mathcal{U}_{C_j} \cap \mathcal{U}_{Q_{\nu_j^{(j)}}}} = \pi_{Q_{\nu_j^{(j)}}}(\mathcal{S}_{Q_{\nu_j^{(j)}}})|_{\mathcal{U}_{C_j} \cap \mathcal{U}_{Q_{\nu_j^{(j)}}}}$$

and enable us to glue (4.12), (4.13) and (4.14) together in order to define a total number of

$$\left(\prod_{i=1}^{\lambda} \# \{\text{triangulations } \mathcal{S}_{P_i}\} \right) \left(\prod_{i=1}^{\mu} \# \{\text{triangulations } \mathcal{S}_{Q_i}\} \right)$$

global resolutions

$$(4.16) \quad \pi : (Y = Y(\mathcal{S}_1, \dots, \mathcal{S}_{P_\lambda}, \mathcal{S}_{Q_1}, \dots, \mathcal{S}_{Q_\mu}), \mathcal{E}(X)) \rightarrow (X, \text{Sing}(X))$$

of the singularities of X , with Y 's obtained from X by replacing $\text{Sing}(X)$ by $\mathcal{E}(X)$. Their *exceptional loci* can be written as

$$\mathcal{E}(X) := \left(\prod_{i=1}^{\lambda} \mathcal{E}_{P_i} \right) \amalg \left(\left(\bigcup_{j=1}^{\kappa} \mathcal{E}_{C_j} \right) \cup \left(\prod_{i=1}^{\mu} \mathcal{E}_{Q_i} \right) \right),$$

where $\mathcal{E}_{C_j} = \{D_{r_j}^{(C_j)} | 1 \leq r_j \leq l_{C_j} - 1\}$ expresses the union of the $l_{C_j} - 1$ prime divisors lying over C_j . All $\pi|_{D_{r_j}^{(C_j)}} : D_{r_j}^{(C_j)} \rightarrow C_j$ are smooth *ruled fibrations* provided with two sections $\cong C_j$ and allowing, in general, exceptional fibers. Indeed, if $Q_{\nu_j^{(j)}}$ is an individual point of C_j , it is $\text{supp}(D_{r_j}^{(C_j)}) \cap \mathcal{U}_{Q_{\nu_j^{(j)}}} = \text{supp}(D_{n^{(\nu_j, r_j)}})$, i.e. the support of a non-compact divisor, realized in the corresponding triangle $s_0 = s(e_1, e_2, e_3)$ by the vertex $n^{(\nu_j, r_j)}$ of $\mathcal{S}_{Q_{\nu_j^{(j)}}}$, and if (in the notation of 3.5. (ii))

$$(4.17) \quad \text{Spl}^1(\mathcal{S}_{Q_{\nu_j^{(j)}}})(n^{(\nu_j, r_j)}) = \{\mathcal{C}(n^{(\nu_j, r_j)}, n_{t^{(\nu_j, r_j)}}^{(\nu_j, r_j)}) | 1 \leq t^{(\nu_j, r_j)} \leq b(n^{(\nu_j, r_j)})\}$$

then

$$\pi^{-1}(Q_{\nu_j^{(j)}}) \cap \mathcal{E}_{C_j} = \bigcup_{r_j=1}^{l_{C_j}-1} \left(\bigcup_{t^{(\nu_j, r_j)}=1}^{b(n^{(\nu_j, r_j)})} \mathcal{C}(n^{(\nu_j, r_j)}, n_{t^{(\nu_j, r_j)}}^{(\nu_j, r_j)}) \right)$$

(i.e. exceptional fibers occur whenever $b(n^{(\nu_j, r_j)}) > 1$, see fig. 3).

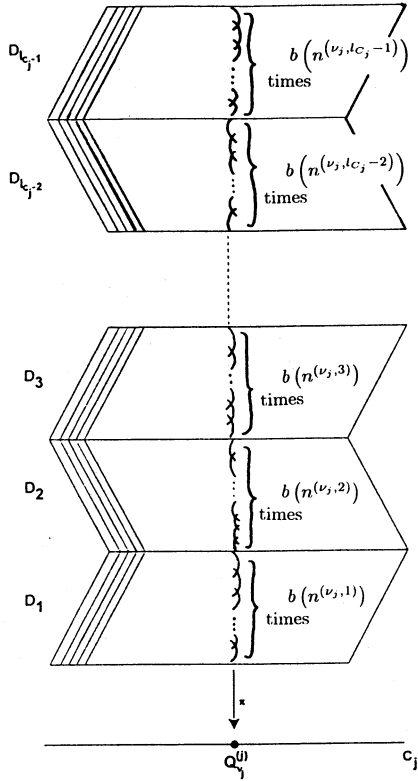

Fig. 3

Proposition 4.3. *The global desingularizations (4.16) of X are all crepant, and each of them differs from another one by finitely many simple flops, being realized by elementary transformations which take place within the fans $\{\Sigma'_0(\mathcal{S}_{P_i}), \Sigma'_0(\mathcal{S}_{Q_i}) | 1 \leq i \leq \lambda, 1 \leq \iota \leq \mu\}$.*

Proof. The verification of the first assertion follows from the construction and [99, thm. 1.14., p. 142]. Now every rational curve $C = C(n_1, n_2)$ representing an 1-simplex in one of the above triangulations $\mathcal{S}_{P_i}, \mathcal{S}_{Q_i}$, which is a diagonal of a convex quadrilateral (determined by lattice points), has normal bundle $\mathcal{N}_{C/Y} \cong \mathcal{O}_C(-1) \oplus \mathcal{O}_C(-1)$ and can therefore be flopped (see [78, 2.3.2.1]). Simple flopping, in our case, means the replacement of the one diagonal of a regarded convex lattice quadrilateral by the other, i.e. the application of an elementary transformation. Hence, the second assertion follows from cor. 3.9. \square

Definition 4.4. Although X and Y 's are not themselves toric varieties, we shall call (4.16) *the toroidal crepant desingularizations of X* , since they can be completely described by means of their local toric data.

Remarks 4.5. (i) Most of Y 's are projective, but, in general, there is no guarantee that *all* of them will be projective. This is why we shall deal here with both possibilities. (Of course, all projective ones are CY threefolds.) For the construction of pathological triangulations for crepant toric resolutions of abelian quotient singularities which lead, after gluing together, to nonprojective threefolds with trivial canonical bundle, as well as for a combinatorial method of how one describes the projective ones, we refer to [24].

(ii) In both cases, Y 's are Moishezon smooth threefolds and admit Hodge decomposition according to a theorem of Deligne (see [27, prop. 5.3., p. 121]). Moreover, all Y 's have *the same* Hodge numbers, because the surgery of “flopping type” does not have any influence upon them (cf. [77, § 4] or [78, § 5]).

(iii) It is not known if X can have crepant desingularizations other than the toroidal ones or not. Nevertheless, a general theorem of Kawamata-Matsuki [70] and Kollár [77, Cor. 5.6.] informs us that the number of all projective crepant desingularizations has to be always finite. The toroidal crepant desingularizations are, so to say, the ones which can be characterized, from the combinatorial point of view, in the best possible manner, because the corresponding “flopping loci” are easily controllable. (There are, of course, examples of X 's containing a plethora of $(-1, -1)$ -curves which do not belong to that class of $(-1, -1)$ -curves being realized as 1-simplices within the “toric triangles” assigned to the dissident points of X . These additional curves can be also “flopped”.)

Before proceeding to the determination of the Hodge numbers of Y 's, we have to introduce some more useful notations. We set $a(P_i) := \#(\mathcal{E}_{P_i})$, $a(Q_\iota) := \#(\mathcal{E}_{Q_\iota})$ and we fix the enumerations

$$(4.18) \quad \mathcal{E}_{P_i} = \{D_{n_{\mathfrak{p}_i}}^{(P_i)} \mid 1 \leq \mathfrak{p}_i \leq a(P_i)\}, \quad \mathcal{E}_{Q_\iota} = \{D_{n_{\mathfrak{q}_\iota}}^{(Q_\iota)} \mid 1 \leq \mathfrak{q}_\iota \leq a(Q_\iota)\}$$

By Prop. 3.4. (i) we get

$$(4.19) \quad a(P_i) = \frac{1}{2}(l_{P_i} - \sum_{\rho=1}^3 \gcd(\alpha_\rho^{(P_i)}, l_{P_i})) + 1$$

$$(4.20) \quad \text{and } a(Q_\iota) = \frac{1}{2}(l_{Q_\iota} - \sum_{\rho=1}^3 \gcd(\alpha_\rho^{(Q_\iota)}, l_{Q_\iota})) + 1$$

Theorem 4.6. *The Hodge numbers of the toroidal crepant desingularization spaces Y of X are the following:*

$$h^{0,0}(Y) = h^{0,3}(Y) = h^{3,0}(Y) = h^{3,3}(Y) = 1, h^{p,q}(Y) = 0, \forall p, q, p \neq q, p + q \neq 3,$$

$$(4.21) \quad h^{1,1}(Y) = \sum_{i=1}^{\lambda} a(P_i) + \sum_{\iota=1}^{\mu} a(Q_{\iota}) + \sum_{j=1}^{\kappa} l_{C_j} - (\kappa - 1)$$

$$(4.22) \quad h^{1,2}(Y) = h^{1,2}(X) + \sum_{j=1}^{\kappa} (l_{C_j} - 1) h^0(C_j, \mathcal{O}_{C_j}(\text{am}(C_j)))$$

($h^{1,2}(X) = h_{\text{prim}}^{1,2}(X)$ and $h^0(C_j, \mathcal{O}_{C_j}(\text{am}(C_j)))$ are known from the formulae (2.17) and (2.20).)

Proof. By (2.5) we know that $h^{p,q}(X) = 1, \forall p, 0 \leq p \leq 3$ and $h^{p,q}(X) = 0$, for $p + q \neq 3, p \neq q$. Since $\text{am}(X) = 0$, formulae (2.6), (2.16) and (2.18) give $h^{3,0}(X) = h^{0,3}(X) = 1$. The desingularization process alters only the remaining non-trivial Hodge numbers $h^{1,1} = h^{2,2}$ and $h^{1,2} = h^{2,1}$. Making use of the Mayer-Vietoris homology (or cohomology) sequences (see [101] (b)), we deduce the following additive splitting for the Betti numbers coming into question:

$$(4.23) \quad b_2(Y) = b_2(X) + \#(\text{exceptional prime divisors w.r.t. } \pi)$$

$$(4.24) \quad b_3(Y) = b_3(X) + \sum_{j=1}^{\kappa} (l_{C_j} - 1) b_1(C_j)$$

The number of the exceptional prime divisors being located only over P_i (resp. Q_{ι}) is $a(P_i)$ (resp. $a(Q_{\iota})$), while over C_j lie exactly $l_{C_j} - 1$ ruled fibrations. Summing them up and setting $b_2(Y) = h^{1,1}(Y)$, $b_2(X) = 1$, we get (4.21) by (4.23). Finally, (4.22) follows from (4.24), because $h^{1,2}(Y) = \frac{1}{2} b_3(Y) - 1$, $b_3(X) = 2(1 + h^{1,2}(X))$ and $b_1(C_j) = 2h^1(C_j, \mathcal{O}_{C_j}) = 2h^0(C_j, \mathcal{O}_{C_j}(\text{am}(C_j)))$. \square

Remarks 4.7. (i) By [32, 3.2.4. (ii)'] X is simply connected. Thus, Y 's are also simply connected, because the fibers of $\pi : Y \rightarrow X$ are simply connected.

(ii) Let us denote a few words on the precise determination of λ and μ in (4.7), (4.8), (4.21), (4.22). Since X is assumed to be well-stratified (cf. 2.36. (b)), each $X(I)$, $I \in \Gamma_0 \cup \hat{\Gamma}_0$, consists of finitely many points (expressing the *same* type of singularity on our model X) and

$$\lambda = \sum_{I \in \Gamma_0} \#(X(I)), \quad \mu = \sum_{I \in \hat{\Gamma}_0} \#(X(I)).$$

For an arbitrary $X(I)$, $I \in \Gamma_0 \cup \hat{\Gamma}_0$, let us fix enumerations

$$\{\tau_1, \dots, \tau_{m-|I|}\} := \{1, \dots, m\} \setminus I,$$

$\{\sigma_1, \dots, \sigma_{k-\nu(I)}\} := \{ \text{a set of indices from } \{1, \dots, k\} \text{ corresponding to polynomials whose restrictions on } \mathbb{P}_I \text{ constitute a minimal set of generators of the defining ideal of } X(I) \text{ in } \mathbb{P}_I \}$,

and write

$$X'(I) = (f'_{\sigma_1} = \dots = f'_{\sigma_{k-\mathcal{V}(I)}} = 0) \subset \mathbb{P}^{m-|I|-1}(w'_{\tau_1}, \dots, w'_{\tau_{m-|I|}})$$

its isomorphic space coming from the normalization of the weights $(w_{\tau_1}, \dots, w_{\tau_{m-|I|}})$ (cf. prop. 2.30.) Obviously, $k - \mathcal{V}(I) = m - |I| - 1$ and it is enough to compute $\sharp(X'(I)) = \sharp(X(I))$. By condition 2.36. (c), $\sharp(X'(I))$ is equal to the number of points of $(f'_{\sigma_1} = \dots = f'_{\sigma_{k-\mathcal{V}(I)}} = 0)$ lying within the algebraic torus $(\mathbb{C}^*)^{m-|I|-1} =: \mathbf{T} = (z_{\tau_1} \cdot z_{\tau_2} \cdots z_{\tau_{m-|I|}} \neq 0)$ being embedded in our w.p.s. Thus, by the Bézout-type formula due to Bernstein and Kouchnirenko (see also [41, § I.6.], [47, pp. 122-124]), we get:

$$\sharp(X'(I)) = \frac{d'_{\sigma_1} \cdots d'_{\sigma_{k-\mathcal{V}(I)}}}{w'_{\tau_1} \cdots w'_{\tau_{m-|I|}}}$$

($\sharp(X'(I))$ is computable, even, if we slightly weaken the above condition. See [41, I.6.6.(2)].)

(iii) The above formulae (4.21) and (4.22) depend, of course, on the defining polynomials of X . However, they turn out to be very efficient if one examines polynomials with special prescribed monomial decompositions, without demanding the fulfillment of any other extra conditions.

On the other hand, in certain cases, if each stratum $X(I)$ is assumed to be defined by polynomials, which are general enough, and if f_1, \dots, f_k can be rearranged in such a way that $(f_1 = \dots = f_\rho = 0)$ is quasismooth, $\forall \rho, 1 \leq \rho \leq k$, then one can use a “gluing technique” of the so called *relative Milnor fibers*, in order to get *explicit* formulae for $h^{1,1}$ and $h^{1,2}$, depending *only* on \mathbf{w} and \mathbf{d} . This computational method will be applied below. Previous results concerning the hypersurface case (i.e. when $k = 1$) are due to Vafa [120] and Roan [101] (b).

Another computation method for the case of hypersurfaces, which are embedded in a Gorenstein toric Fano variety, was recently presented by Batyrev [7]. Batyrev’s approach is mainly based on the study of the ambient space and its associated polyhedron and it is also applicable to partial crepant resolutions of arbitrary dimension. The regarded Hodge numbers are expressible by the numbers of the integral points of certain polyhedron faces. Moreover, for some families of hypersurfaces in spaces corresponding to reflexive polyhedra, the classical involutive duality of convex sets leads to a precise mathematical interpretation of the so called *mirror phenomena*. These phenomena have been initially observed by the physicists within the framework of investigations of special conformal field theories. Their first rigorous mathematical formulation for the special case of hypersurfaces in w.p.s. is due to Roan [102] (a), who constructed “mirror isomorphisms” by using an *explicit* lattice dualism.

Definition 4.8. For $\rho, 1 \leq \rho \leq k$, let X^ρ be a w.c.i.

(4.25)

$$\{[z_1, \dots, z_m] \in \mathbb{P}^{m-1}(w_1, \dots, w_m) \mid f_1(z_1, \dots, z_m) = \dots = f_\rho(z_1, \dots, z_m) = 0\}$$

with $\deg(f_\rho) = d_\rho$ and $X := X^k := X_{(d_1, \dots, d_k)}$, $X^0 := \mathbb{P}^{m-1}(\mathbf{w})$. X will be called *overall well-stratified* (w.r.t. the above enumeration of its defining polynomials) if X^ρ is well-stratified (see 2.36) for all ρ ’s.

Definition 4.9. Let $X = X_{(d_1, \dots, d_k)}$ be an overall well-stratified w.c.i. with a fixed enumeration (4.25) of its defining polynomials. For all ρ , $1 \leq \rho \leq k$, $(CN(X^\rho), \mathbf{0})$ is the zero locus of the holomorphic function germ $f_\rho : (CN(X^{\rho-1}), \mathbf{0}) \rightarrow (\mathbb{C}, 0)$. For a sufficiently small $\varepsilon > 0$ we consider the open ball

$$B_\varepsilon(\mathbf{0}) := \{\mathbf{z} \in \mathbb{C}^m : \|\mathbf{z}\| < \varepsilon\}.$$

$CN(X^\rho) \cap \overline{\partial B_\varepsilon(\mathbf{0})}$ is a $(m - \rho - 2)$ -connected $(2(m - \rho) - 1)$ -dimensional orientable C^∞ -differentiable manifold and $CN(X^\rho) \cap \overline{B_\varepsilon(\mathbf{0})}$ is homeomorphic to the cone $\{t\mathbf{z} \mid 0 \leq t \leq 1, \mathbf{z} \in CN(X^\rho) \cap \overline{\partial B_\varepsilon(\mathbf{0})}\}$ over $\text{Lk}(\rho) := CN(X^\rho) \cap \overline{\partial B_\varepsilon(\mathbf{0})}$. $\text{Lk}(\rho)$ is called *the relative link* of the origin in $CN(X^\rho)$ w.r.t. $CN(X^{\rho-1})$. By assumption, the set of critical points of $f_\rho|_{CN(X^{\rho-1})}$ consists only of the zero point. We can therefore choose $\varepsilon \gg \varepsilon'$ small enough in order to construct two fibrations

$$\hat{f}_\rho : (f_\rho|_{CN(X^{\rho-1})})^{-1}(\overline{B_{\varepsilon'}(\mathbf{0})}) \cap B_\varepsilon(\mathbf{0}) \setminus \{0\} \rightarrow \overline{B_{\varepsilon'}(\mathbf{0})} \setminus \{0\}$$

and

$$\varphi_\rho := \frac{\hat{f}_\rho}{\|\hat{f}_\rho\|} : \text{Lk}(\rho - 1) \setminus \text{Lk}(\rho) \rightarrow S^1.$$

The inclusion $\overline{\partial B_{\frac{\varepsilon'}{2}}(\mathbf{0})} \hookrightarrow (B_{\varepsilon'}(\mathbf{0}) \setminus \{0\})$ is an homotopy equivalence and consequently all topological properties of the first fibration are preserved (up to homotopy) by its restriction over the circle $\overline{\partial B_{\frac{\varepsilon'}{2}}(\mathbf{0})}$. By identifying $\overline{\partial B_{\frac{\varepsilon'}{2}}(\mathbf{0})}$ with the unit circle S^1 via the map $\tau \mapsto \frac{2\tau}{\varepsilon'}$, we regard this new restricted fibration over S^1 , which we shall denote again by \hat{f}_ρ . \hat{f}_ρ and φ_ρ are (in this sense) fiberwise diffeomorphic in the category of the locally trivial fibrations over S^1 and define *the relative Milnor fibration* of $CN(X^\rho)$ w.r.t. $CN(X^{\rho-1})$. The fibers F^ρ are homotopic to a bouquet $S^{m-\rho} \vee \dots \vee S^{m-\rho}$ of $(m - \rho)$ -spheres (see [58]). The number of these spheres is called the *relative Milnor number* $\text{mil}(F^\rho)$ of $CN(X^\rho)$ w.r.t. $(X^{\rho-1})$. It is easy to see that the topological Euler-Poincaré characteristic of F^ρ is given by $e(F^\rho) = 1 + (-1)^{m-\rho} \text{mil}(F^\rho)$ and $\text{mil}(F^\rho) = \text{rk}(\tilde{H}_{m-\rho}(F^\rho, \mathbb{Z}))$. F^ρ is furthermore diffeomorphic to $\{(z_1, \dots, z_m) \in \mathbb{C}^m \mid f_1(z_1, \dots, z_m) = \dots = f_{\rho-1}(z_1, \dots, z_m) = 0, f_\rho(z_1, \dots, z_m) = 1\}$ and its associated *characteristic automorphism* $\mathfrak{h}_\rho : F^\rho \rightarrow F^\rho$, coming from the fiber transport via the standard generator of $\pi_1(S^1, \{1\})$, is given by $\mathfrak{h}_\rho(z_1, \dots, z_m) := \zeta_{d_\rho} \cdot (z_1, \dots, z_m) = (\zeta_{d_\rho}^{w_1} z_1, \dots, \zeta_{d_\rho}^{w_m} z_m)$.

For an X as above and indices $0 \leq r_\rho \leq d_\rho - 1$, $0 \leq s_\rho \leq d_\rho - 1$, $1 \leq \rho \leq k$, we introduce the following index-sets and enumerate them increasingly:

$$\begin{aligned}
N_\rho(r_\rho) &:= \left\{ i \mid 1 \leq i \leq m : \frac{r_\rho w_i}{d_\rho} \in \mathbb{Z} \right\} = \left\{ \nu_1^{(r_\rho)}, \dots, \nu_{\alpha_\rho(r_\rho)}^{(r_\rho)} \right\}, \\
\Xi_\rho(r_\rho) &:= \left\{ e \mid 1 \leq e \leq \rho : \frac{r_\rho d_e}{d_\rho} \in \mathbb{Z} \right\} = \left\{ \xi_1^{(r_\rho)}, \dots, \xi_{\beta_\rho(r_\rho)}^{(r_\rho)} \right\}, \\
T(r_\rho, s_\rho) &:= \left\{ t \mid 1 \leq t \leq \alpha(r_\rho) : \frac{s_\rho w_{t(r_\rho)}}{d_\rho} \in \mathbb{Z} \right\} = \left\{ \tau_1^{(r_\rho, s_\rho)}, \dots, \tau_{\gamma_\rho(r_\rho, s_\rho)}^{(r_\rho, s_\rho)} \right\}, \\
V(r_\rho, s_\rho) &:= \left\{ l \mid 1 \leq l \leq \beta(r_\rho) : \frac{s_\rho d_{\xi_l(r_\rho)}}{d_\rho} \in \mathbb{Z} \right\} = \left\{ v_1^{(r_\rho, s_\rho)}, \dots, v_{\varepsilon_\rho(r_\rho, s_\rho)}^{(r_\rho, s_\rho)} \right\},
\end{aligned}$$

$$\mathcal{L}^{(j)} := \begin{cases} \{r_k \mid 1 \leq r_k \leq d_k - 1 \text{ with } \alpha_k(r_k) - \beta_k(r_k) = 2\}, & \text{if } j = k \\ \{r_j \mid 1 \leq r_j \leq d_j - 1 \text{ with } \alpha_k(r_j) - \beta_k(r_j) = 2 \text{ and} \\ N_j(r_j) \neq N_l(r_l), \forall l, j+1 \leq l \leq k \text{ and} \\ \forall r_l, 0 \leq r_l \leq d_l - 1\}, & \text{if } j \neq k \end{cases}$$

where the j in the last expression is bounded by $1 \leq j \leq k$ and $\{j : 1 \leq j \leq k \mid \mathcal{L}^{(j)} \neq \emptyset\} = \{j_1, \dots, j_q\}$. Furthermore we need the following abbreviations:

$$\mathfrak{Z}(r_\rho, s_\rho) := \left(\prod_{l=1}^{\varepsilon_\rho(r_\rho, s_\rho)} d_{\xi_{v_l(r_\rho, s_\rho)}^{(r_\rho)}} \right) \left(\prod_{t=1}^{\gamma_\rho(r_\rho, s_\rho)} w_{\tau_t^{(r_\rho, s_\rho)}^{(r_\rho)}} \right)^{-1},$$

$$\begin{aligned}
\mathfrak{Y}_\rho(r_\rho, s_\rho) &:= \\
&= \sum_{i=0}^{\varepsilon(\rho)} (-1)^i D_i \left(d_{\xi_{v_1(r_\rho, s_\rho)}^{(r_\rho)}}, \dots, d_{\xi_{v_{\varepsilon_\rho(r_\rho, s_\rho)}^{(r_\rho)}}^{(r_\rho)}} \right) W_{\varepsilon(\rho)-i} \left(w_{\tau_1^{(r_\rho, s_\rho)}^{(r_\rho)}}, \dots, w_{\tau_{\gamma_\rho(r_\rho, s_\rho)}^{(r_\rho)}} \right),
\end{aligned}$$

defined by means of the symmetric polynomials (2.7), (2.8), with $\varepsilon(\rho) := \gamma_\rho(r_\rho, s_\rho) - \varepsilon_\rho(r_\rho, s_\rho)$,

$$e(r_\rho, s_\rho) := \begin{cases} 0, & \text{if } \varepsilon(\rho) < 0 \\ \mathfrak{Z}(r_\rho, s_\rho) \cdot \mathfrak{Y}(r_\rho, s_\rho), & \text{if } \varepsilon(\rho) \geq 0 \end{cases}$$

$$g_{r_\rho}^{(\rho)} := \frac{1}{d_\rho} \sum_{s_\rho=0}^{d_\rho-1} (1 - e(r_\rho, s_\rho))$$

and

$$\mathfrak{G}_{r_{j_\lambda}}^{(j_\lambda)} := \begin{cases} 0, & \text{if } j_\lambda = 1 \\ \sum_{\sigma=1}^{j_\lambda-1} \tilde{g}_{r_\sigma}^{(\sigma)}, & \text{if } j_\lambda \geq 2 \end{cases}$$

with

$$\tilde{g}_{r_\sigma}^{(\sigma)} := \begin{cases} 0, & \text{if } \nexists r_\sigma, 0 \leq r_\sigma \leq d_\sigma - 1, \text{ with } N_\sigma(r_\sigma) = N_{j_\lambda}(r_{j_\lambda}) \\ g_{\hat{r}_\sigma}^{(\sigma)}, & \text{if } \exists \hat{r}_\sigma = r_\sigma \text{ with } 0 \leq \hat{r}_\sigma \leq d_\sigma - 1 \text{ and} \\ N_\sigma(\hat{r}_\sigma) = N_{j_\lambda}(r_{j_\lambda}), \forall \sigma, 1 \leq \sigma \leq j_\lambda - 1 \end{cases}$$

for $1 \leq \sigma \leq j_\lambda - 1$ and $1 \leq \lambda \leq q$.

Lemma 4.10. *Let $F^\rho(r_\rho) := (F^\rho)^{\mathfrak{h}^{r_\rho}}$ denote the fixed point set of \mathfrak{h}^{r_ρ} . Suppose $F^\rho(r_\rho) \neq \emptyset$. Then*

$$F^\rho(r_\rho) = \{(z_1, \dots, z_m) \in \mathbb{C}^m \mid f_j(z_1, \dots, z_m) = 0, \forall j, 1 \leq j \leq \rho - 1, j \in \Xi_\rho(r_\rho), \\ f_\rho(z_1, \dots, z_m) = 1 \text{ and } z_i = 0, \forall i, 1 \leq i \leq m, i \notin N_\rho(r_\rho)\}$$

is an affine complete intersection of dimension $\alpha_\rho(r_\rho) - \beta_\rho(r_\rho)$ w.r.t. the weights $\{w_{\nu_1^{(r_\rho)}}, \dots, w_{\nu_{\alpha_\rho(r_\rho)}^{(r_\rho)}}\}$ in the $\alpha_\rho(r_\rho)$ variables $z_{\nu_1^{(r_\rho)}}, \dots, z_{\nu_{\alpha_\rho(r_\rho)}^{(r_\rho)}}$ with no singular points other than the origin. $F^\rho(r_\rho)$ is also diffeomorphic to the relative Milnor fiber w.r.t.

$$f_\rho : (\{(z_{\nu_1^{(r_\rho)}}, \dots, z_{\nu_{\alpha_\rho(r_\rho)}^{(r_\rho)}}) \in \mathbb{C}^{\alpha_\rho(r_\rho)} \mid f_j(z_{\nu_1^{(r_\rho)}}, \dots, z_{\nu_{\alpha_\rho(r_\rho)}^{(r_\rho)}}) = 0, \\ \forall j, 1 \leq j \leq \rho - 1, j \in \Xi_\rho(r_\rho)\}, \mathbf{0}) \rightarrow (\mathbb{C}, 0).$$

Proof. Let $t := \zeta_{d_\rho}^{r_\rho}$ and consider the maps $\psi_\rho := (f_1, \dots, f_\rho) : \mathbb{C}^m \rightarrow \mathbb{C}^\rho$, resp. $\mathbb{C}^m \ni \mathbf{z} \mapsto {}^t\psi_\rho(\mathbf{z}) := \psi_\rho(t \cdot \mathbf{z}) \in \mathbb{C}^\rho$, where $t \cdot \mathbf{z} := (t^{w_1} z_1, \dots, t^{w_m} z_m)$. The chain rule gives

$$\mathbf{D}({}^t\psi_\rho(\mathbf{z})) = (\mathbf{D}\psi_\rho(t \cdot \mathbf{z})) \cdot \text{diag}(t^{w_1}, \dots, t^{w_m}) = \text{diag}(t^{d_1}, \dots, t^{d_\rho}) \cdot (\mathbf{D}\psi_\rho(\mathbf{z})).$$

For $\mathbf{z} \in F^\rho(r_\rho)$ we have $t \cdot \mathbf{z} = \mathbf{z}$ and therefore

$$t^{w_i} \frac{\partial f_j}{\partial z_i} = t^{d_j} \frac{\partial f_j}{\partial z_i}, \forall i, 1 \leq i \leq m, \forall j, 1 \leq j \leq \rho.$$

This means that

$$\frac{\partial f_j}{\partial z_i} = 0 \quad \text{if} \quad \begin{cases} \text{either} & i \notin N_\rho(r_\rho) \text{ and } j \in \Xi_\rho(r_\rho) \\ \text{or} & i \in N_\rho(r_\rho) \text{ and } j \notin \Xi_\rho(r_\rho). \end{cases}$$

On the other hand the functions $\{f_j \mid j \notin \Xi_\rho(r_\rho)\}$ are constant on

$$\{\mathbf{z} \in \mathbb{C}^m \mid t \cdot \mathbf{z} = \mathbf{z}\} = \{\mathbf{z} \in \mathbb{C}^m \mid z_i = 0, \forall i, 1 \leq i \leq m, i \notin N_\rho(r_\rho)\}$$

and therefore vanish. Thus, $F^\rho(r_\rho)$ has the above form. Moreover, for every point $\mathbf{z}^0 \in (F^\rho(r_\rho) \setminus \{\mathbf{0}\})$, we get for the Jacobian block matrix:

$$\mathrm{rk} \left(\frac{\partial f_j}{\partial z_i} \Big|_{\mathbf{z}=\mathbf{z}^0} \right)_{\substack{i \in N_\rho(r_\rho) \\ j \in \Xi_\rho(r_\rho)}} = \beta_\rho(r_\rho)$$

and $F^\rho(r_\rho)$ cannot have \mathbf{z}^0 as a singular point. \square

Now \mathfrak{h}_ρ induces the automorphism:

$$\mathfrak{h}_\rho(r_\rho) : F^\rho(r_\rho) \ni (z_{\nu_1(r_\rho)}, \dots, z_{\nu_{\alpha_\rho(r_\rho)}(r_\rho)}) \mapsto (\zeta_{d_\rho}^{w_{\nu_1(r_\rho)}} z_{\nu_1(r_\rho)}, \dots, \zeta_{d_\rho}^{w_{\nu_{\alpha_\rho(r_\rho)}}(r_\rho)} z_{\nu_{\alpha_\rho(r_\rho)}(r_\rho)}) \in F^\rho(r_\rho)$$

and the cyclic group $\langle \mathfrak{h}_\rho(r_\rho) \rangle$ generated by $\mathfrak{h}_\rho(r_\rho)$ has the order

$$d_{r_\rho} := \frac{d_\rho}{\mathrm{gcd} \{w_i | i \in N_\rho(r_\rho)\}}$$

For $0 \leq r_\rho \leq d_\rho - 1$, $0 \leq s_\rho \leq d_\rho - 1$, we get $F^\rho(r_\rho)^{\mathfrak{h}_\rho(r_\rho)^{s_\rho}} = F^\rho(r_\rho) \cap F^\rho(s_\rho) =: F^\rho(r_\rho, s_\rho)$ and $F^\rho(r_\rho)^{\mathfrak{h}_\rho(r_\rho)^{s'_\rho}} = F^\rho(r_\rho)^{\mathfrak{h}_\rho(r_\rho)^{s'_\rho}}$ if $0 \leq s'_\rho \leq d_\rho - 1$ with $s_\rho \equiv s'_\rho \pmod{d_{r_\rho}}$. As in the previous lemma, we can conclude that $F^\rho(r_\rho, s_\rho)$ is an affine c.i. of dimension $\epsilon(\rho)$ with $\mathbf{0}$ as the only singular point (for $\epsilon(\rho) \geq 0$). From the Lefschetz fixed point formula we deduce:

$$\begin{aligned} 1 - e(F^\rho(r_\rho)/\langle \mathfrak{h}_\rho \rangle) &= 1 - \frac{1}{d_{r_\rho}} \sum_{s_\rho=0}^{d_\rho-1} e(F^\rho(r_\rho)^{\mathfrak{h}_\rho(r_\rho)^{s_\rho}}) = \\ (4.26) \quad &= 1 - \frac{1}{d_\rho} \sum_{s_\rho=0}^{d_\rho-1} e(F^\rho(r_\rho, s_\rho)) = \frac{1}{d_\rho} \sum_{s_\rho=0}^{d_\rho-1} (1 - e(F^\rho(r_\rho, s_\rho))). \end{aligned}$$

Theorem 4.11. *Let $X = X_{(d_1, \dots, d_k)} \subset \mathbb{P}^{m-1}(\mathbf{w})$ be a well-formed, overall well-stratified c.i. with $m - k = 4$, $\mathrm{am}(X) = 0$. Then the non-trivial Hodge numbers of the toroidal crepant desingularizations $\pi : Y \rightarrow X$ of X are given by:*

$$(4.27) \quad h^{1,1}(Y) = \frac{1}{2}e(Y) + h^{1,2}(Y), \quad \text{where}$$

$$(4.28) \quad e(Y) = \sum_{\rho=1}^k \sum_{r_\rho=0}^{d_\rho-1} g_{r_\rho}^{(\rho)} \quad \text{and}$$

$$(4.29) \quad h^{1,2}(Y) = h^{1,2}(X) - \frac{1}{2} \left(\sum_{\lambda=1}^q \sum_{r_{j_\lambda} \in \mathcal{L}^{(j_\lambda)}} (\mathfrak{G}_{r_{j_\lambda}}^{(j_\lambda)} + g_{r_{j_\lambda}}^{(j_\lambda)}) \right)$$

Proof. (4.27) is obvious. By prop. 3.2. we can see that for all strata $X_I := X(I)$ of X and $I \subsetneq M \subset \{1, \dots, m\}$,

$$\pi : (\pi^{-1}(X_I \setminus \cup \{X_M : I \subsetneq M\})) \rightarrow X_I \setminus \cup \{X_M : I \subsetneq M\}$$

is a fibration with $e(\text{fiber}) = c_I$ (cf. 2.5., 2.18.). The stratification of Y gives

$$(4.30) \quad e(Y) = \sum_I \left(\sum_{I \subset J} (-1)^{|I|+|J|} e(X_J) \right) c_I.$$

By assumption, $X_I^\rho := X^\rho \cap \mathbb{P}_I$ (in the notation of 2.5.) is a q.s.c.i. Since X_I^ρ appears as the support of a *subcomplex* in a *topological triangulation* of $X_I^{\rho-1}$ (see [83]), the exact cohomology sequence concerning the complements $U_I^\rho := X_I^{\rho-1} \setminus X_I^\rho$ ([13, p. 52]):

$$\dots \rightarrow H^i(U_I^\rho, \mathbb{Q}) \rightarrow H^i(X_I^{\rho-1}, \mathbb{Q}) \rightarrow H^i(X_I^\rho, \mathbb{Q}) \rightarrow H^{i+1}(U_I^\rho, \mathbb{Q}) \rightarrow \dots$$

yields: $e(U_I^\rho) = e(X_I^{\rho-1}) - e(X_I^\rho)$, $\forall \rho, 1 \leq \rho \leq k$. Summing these k equations together, we get for $X_I := X_I^k$:

$$(4.31) \quad e(X_I) = e(\mathbb{P}_I) - \sum_{\rho=1}^k e(U_I^\rho)$$

If we set $\mathcal{I}_\rho := \{I \subset \{1, \dots, m\} \mid U_I^\rho \neq \emptyset\}$, then $e(Y)$, according to (4.30) and (4.31), can be written as:

$$(4.32) \quad e(Y) = \sum_I [e(\mathbb{P}_I) - e(\cup\{\mathbb{P}_J \mid I \subsetneq J\})] c_I - \sum_{\rho=1}^k \sum_{I \in \mathcal{I}_\rho} [e(U_I^\rho) - e(\cup\{U_J^\rho \mid I \subsetneq J\})] c_I$$

Combining this with $e(\mathbb{P}_I) - e(\cup\{\mathbb{P}_J \mid I \subsetneq J\}) = \begin{cases} 1, & \text{if } |I| = m-1 \\ 0, & \text{otherwise} \end{cases}$

we have:

$$(4.33) \quad e(Y) = \sum_{i=1}^m w_i - \sum_{\rho=1}^k \sum_{I \in \mathcal{I}_\rho} [e(U_I^\rho) - e(\cup\{U_J^\rho \mid I \subsetneq J\})]$$

Defining $U_I^{\prime\rho} := U_I^\rho \setminus \cup\{U_J^\rho \mid I \subsetneq J\}$, we show similarly

$$(4.34) \quad \begin{aligned} e(U_I^{\prime\rho}) &= e(U_I^\rho) - e(\cup\{U_J^\rho \mid I \subsetneq J\}) \quad \text{and} \\ e(U_I^\rho) &= \sum_{I \subset J} e(U_J^{\prime\sigma}), \quad \forall I \in \mathcal{I}_\rho. \end{aligned}$$

The transition from the local to the global data can be achieved via the relative Milnor fibers F^ρ , by identifying $F^\rho / \langle \mathfrak{h}_\rho \rangle$ and $U^\rho = X^{\rho-1} \setminus X^\rho$ by means of the projection

$q_\rho : F^\rho \ni (z_1, \dots, z_m) \mapsto [z_1, \dots, z_m] \in U^\rho$, for all ρ , $1 \leq \rho \leq k$.

Moreover, for $I \in \mathcal{I}_\rho$, $q_\rho^{-1}(U_I^\rho)$ is \mathfrak{h}_ρ -invariant and

$$\begin{aligned}
(4.35) \quad & \#\{r_\rho | 0 \leq r_\rho \leq d_\rho - 1 : F^\rho(r_\rho)/\langle \mathfrak{h}_\rho \rangle \supset U_I^\rho\} = \\
& \#\{r_\rho | 0 \leq r_\rho \leq d_\rho - 1 : \mathfrak{h}_\rho^{r_\rho} = \text{id on } q_\rho^{-1}(U_I^\rho)\} = \\
& = \#\{r_\rho | 0 \leq r_\rho \leq d_\rho - 1 : \frac{d_\rho}{c_I} | r_\rho\} = c_I.
\end{aligned}$$

Hence (4.33), (4.34) give:

$$\begin{aligned}
e(Y) &= \sum_{\rho=1}^k \left[d_\rho - \sum_{I \in \mathcal{I}_\rho} e(U_I^\rho) c_I \right] \quad (\text{since } \sum_{i=1}^m w_i = \sum_{\rho=1}^k d_\rho) \\
&\stackrel{(4.35)}{=} \sum_{\rho=1}^k \left[d_\rho - \sum_{r_\rho=0}^{d_\rho-1} \left(\sum \{e(U_{J^\rho}^\rho) | F^\rho(r_\rho)/\langle \mathfrak{h}_\rho \rangle \supset U_{J^\rho}^\rho\} \right) \right] \\
&\stackrel{(4.34)}{=} \sum_{\rho=1}^k \left[d_\rho - \sum_{r_\rho=0}^{d_\rho-1} e(F^\rho(r_\rho)/\langle \mathfrak{h}_\rho \rangle) \right] \\
&= \sum_{\rho=1}^k \sum_{r_\rho=0}^{d_\rho-1} [1 - e(F^\rho(r_\rho)/\langle \mathfrak{h}_\rho \rangle)] \\
&\stackrel{(4.26)}{=} \sum_{\rho=1}^k \sum_{r_\rho=0}^{d_\rho-1} g_{r_\rho}^{(\rho)},
\end{aligned}$$

because $e(F^\rho(r_\rho, s_\rho)) = 1 + (-1)^{\epsilon(\rho)} \text{mil}(F^\rho(r_\rho, s_\rho)) = e(r_\rho, s_\rho)$ by the formulae of Greuel and Hamm in [52, Cor. 3.8. (b), p. 76]. So (4.28) is proven. Now if we define $J_{r_{j_\lambda}} := \{1, \dots, m\} \setminus N_{j_\lambda}(r_{j_\lambda})$, $\forall \lambda$, $1 \leq \lambda \leq q$, we have

$$\text{SSt}^1(X) = \{X_{J_{j_\lambda}} | 1 \leq \lambda \leq q\}.$$

(Warning (*) ! $X_{J_{j_\lambda}}$ represents the *same curve* for all r_{j_λ} 's of the form $r_{j_\lambda} = t_{j_\lambda} \cdot \frac{d_{j_\lambda}}{c_{J_{r_{j_\lambda}}}}$, $1 \leq t_{j_\lambda} \leq c_{J_{r_{j_\lambda}}}$.)

On the other hand, for all λ , $1 \leq \lambda \leq q$, $1 \leq r_{j_\lambda} \leq d_{j_\lambda} - 1$, we get:

$$\begin{aligned}
b_1(X_{J_{r_{j_\lambda}}}) &= 2 - e(X_{J_{r_{j_\lambda}}}) = 2 - e(\mathbb{P}_{J_{r_{j_\lambda}}}) + \sum_{\rho=1}^{j_\lambda} e(U_{J_{r_{j_\lambda}}}^\rho) = \\
&= 2 - \{(m-1) - [(m-2) - \beta_{j_\lambda}(r_{j_\lambda})] + 1\} + \sum_{\rho=1}^{j_\lambda} e(U_{J_{r_{j_\lambda}}}^\rho) =
\end{aligned}$$

(Note that exactly $j_\lambda - \beta_{j_\lambda}(r_{j_\lambda})$ of the $U_{J_{r_{j_\lambda}}}^\rho$'s are empty !)

$$\begin{aligned} &= - \sum_{u=1}^{\beta_{j_\lambda}(r_{j_\lambda})} (1 - e(U_{J_{r_{j_\lambda}}}^{\xi_u^{(r_{j_\lambda})}})) = \quad (\text{here is } \xi_{\beta_{j_\lambda}(r_{j_\lambda})}^{(r_{j_\lambda})} = j_\lambda) \\ &= - \sum_{u=1}^{\beta_{j_\lambda}(r_{j_\lambda})} g_{r_{j_\lambda}}^{\xi_u^{(r_{j_\lambda})}} = - \sum_{p=1}^{\beta_{j_\lambda}(r_{j_\lambda})-1} g_{r_{j_\lambda}}^{\xi_p^{(r_{j_\lambda})}} - g_{r_{j_\lambda}}^{(j_\lambda)} \end{aligned}$$

by the identification of $U_{J_{r_{j_\lambda}}}^{\xi_u^{(r_{j_\lambda})}}$ with $F^{\xi_u^{(r_{j_\lambda})}}(r_{\xi_u^{(r_{j_\lambda})}})/\langle \mathfrak{h}_{\xi_u^{(r_{j_\lambda})}} \rangle$ and for all $r_{\xi_u^{(r_{j_\lambda})}}$'s for which $N_{\xi_u^{(r_{j_\lambda})}}(r_{j_\lambda}) = N_{j_\lambda}(r_{j_\lambda})$ holds.

If C is an irreducible curve in $\text{SSt}^1(X)$ with $C = X_{J_{r_{j_\lambda}}}$ for some $\lambda \in \{1, \dots, q\}$, we have exactly $c_{J_{r_{j_\lambda}}} - 1$ exceptional prime divisors of Y lying over C . To express $\Sigma\{(l_C - 1)b_1(C) | C \in \text{SSt}^1(X)\}$ in terms of \mathbf{d} and \mathbf{w} , it is sufficient (by (*)) to sum our $b_1(X_{J_{r_{j_\lambda}}})$'s over all λ 's and r_{j_λ} 's included in $\mathcal{L}^{(j_\lambda)}$. The representatives of the required additional summands, which occur w.r.t. each stratum, can be obviously abbreviated by $\mathfrak{G}_{r_{j_\lambda}}^{(j_\lambda)}$. Hence, the above sum equals

$$\sum_{\lambda=1}^q \sum_{r_{j_\lambda} \in \mathcal{L}^{(j_\lambda)}} (\mathfrak{G}_{r_{j_\lambda}}^{(j_\lambda)} + g_{r_{j_\lambda}}^{(j_\lambda)})$$

and (4.29) follows directly from (4.24). \square

Let us now apply the formulae of thm. 4.6. (or, alternatively, of thm. 4.11.) for the non-trivial Hodge and Betti numbers to the spaces of crepant toroidal desingularizations of 3-dimensional BP q.s.c.i (with vanishing amplitude) of cor. 2.39. The classification of these CY models is given by the following:

Proposition 4.12. *Up to permutations of weights and degrees and up to different coefficients of the defining polynomials, there exist exactly 171 BP q.s.c. intersections*

$$X = X_{(d_1, \dots, d_k)} = \{[z_1, \dots, z_m] \in \mathbb{P}^{m-1}(\mathbf{w}) \mid \sum_{i=1}^m \lambda_{ij} z_i^{\alpha_{ij}} = 0, \forall j, 1 \leq j \leq k\}$$

of dimension $m - k - 1 = 3$ and of vanishing amplitude satisfying the assumptions of cor. 2.39. (see Table 1). More precisely, there are 147 with codimension $k = 1$, 19 with $k = 2$, 4 with $k = 3$, one with $k = 4$ and none with $k \geq 5$. Only 10 of these complete intersections are smooth. (They are marked with **.) In particular, $X_6 \subset \mathbb{P}^4(1, 1, 1, 1, 2)$ (resp. $X_8 \subset \mathbb{P}^4(1, 1, 1, 1, 4)$) expresses a triple (resp. a double) covering of \mathbb{P}^3 branched along a smooth sextic (resp. octic) surface. All the others certain singular loci consisting of κ irreducible curves, λ isolated points and μ

individual points. If for all $(k+m)$ -tuples $((d_1, \dots, d_k), (w_1, \dots, w_m))$, we denote by

$$\Gamma'_1 := \{\{i_1, \dots, i_{k+2}\} \subset \{1, \dots, m\} \mid 1 \leq i_1 < i_2 < \dots < i_{k+2} \leq m \\ \text{and } \gcd(w_{i_1}, \dots, w_{i_{k+2}}) > 1\},$$

$$\Gamma'_0 := \{\{i_1, \dots, i_{k+1}\} \subset \{1, \dots, m\} \mid 1 \leq i_1 < i_2 < \dots < i_{k+1} \leq m \text{ with} \\ \gcd(w_{i_1}, \dots, w_{i_{k+1}}) > 1 \text{ and} \\ \gcd(w_{i_1}, \dots, w_{i_{k+1}}, w_j) = 1, \forall j, j \in \{1, \dots, m\} \setminus \{i_1, \dots, i_{k+1}\}\},$$

and

$$\hat{\Gamma}'_0 := \{\{i_1, \dots, i_{k+1}\} \subset \{1, \dots, m\} \mid 1 \leq i_1 < i_2 < \dots < i_{k+1} \leq m \text{ with} \\ \gcd(w_{i_1}, \dots, w_{i_{k+1}}) > 1, \gcd(w_{i_1}, \dots, w_{i_{k+1}}, w_j) > 1 \text{ for at least one} \\ j \in \{1, \dots, m\} \setminus \{i_1, \dots, i_{k+1}\} \text{ and } \gcd(w_{i_1}, \dots, w_{i_{k+1}}) > \gcd(w_{i_1}, \dots, w_{i_{k+1}}, w_j) \\ \text{for all that } j\text{'s satisfying this property}\}$$

the complements of Γ_1, Γ_0 and $\hat{\Gamma}_0$ w.r.t. the index set $\{1, \dots, m\}$, then $\kappa = \#(\Gamma'_1)$ and λ (resp. μ) is given by the formula

$$\sum_{\{i_1, \dots, i_{k+1}\}} \left(\frac{\gcd(w_{i_1}, \dots, w_{i_{k+1}}) \cdot \prod_{j=1}^k d_j}{\prod_{\rho=1}^{k+1} w_{i_\rho}} \right)$$

where the sum runs over all the $(k+1)$ -tuples $\{i_1, \dots, i_{k+1}\}$ of Γ'_0 (resp. of $\hat{\Gamma}'_0$). Moreover, for all non-individual points P of a curve $C = X_{\{n_1, n_2\}}$, with $\{n_1, n_2\} = \{1, \dots, m\} \setminus \{i_1, \dots, i_{k+2}\}$, $\{i_1, \dots, i_{k+2}\} \in \Gamma'_1$, we have:

$$(4.36) \quad (X, P) \cong (\mathbb{C}^2 / G_C \times \mathbb{C}, [0] \times \{0\}),$$

where $(\mathbb{C}^2 / G_C, [0])$ is a c.q.s. of type $(\ell_C; [w_{n_1}]_{\ell_C}, [w_{n_2}]_{\ell_C})$ with $\ell_C := \gcd(w_{i_1}, \dots, w_{i_{k+2}})$. Correspondingly, for $P \in X_{\{n_1, n_2, n_3\}}$, $\{n_1, n_2, n_3\} = \{1, \dots, m\} \setminus \{i_1, \dots, i_{k+1}\}$, $\{i_1, \dots, i_{k+1}\} \in \Gamma'_0 \cup \hat{\Gamma}'_0$, we have:

$$(4.37) \quad (X, P) \cong (\mathbb{C}^3 / G_P, [0]),$$

i.e. the germ of X at P is isomorphic to that of a c.q.s. of type $(\ell_P; y_1, y_2, y_3)$ with $\ell_P := \gcd(w_{i_1}, \dots, w_{i_{k+1}})$ and

$$(y_1, y_2, y_3) := \begin{cases} ([w_{n_1}]_{\ell_P}, [w_{n_2}]_{\ell_P}, [w_{n_3}]_{\ell_P}), & \text{if } \sum_{s=1}^3 [w_{n_s}]_{\ell_P} = \ell_P \\ (\ell_P - [w_{n_1}]_{\ell_P}, \ell_P - [w_{n_2}]_{\ell_P}, \ell_P - [w_{n_3}]_{\ell_P}), & \text{if } \sum_{s=1}^3 [w_{n_s}]_{\ell_P} = 2\ell_P. \end{cases}$$

(Using the types of dissident points of $\text{Sing}(X)$ for all X 's of Table 1 with $\text{SSt}^0(X) \amalg \text{INP}(X) \neq \emptyset$, we have marked with a * the 56 models which admit a unique toroidal crepant desingularization.)

For the proof of 4.12. we need the following lemma:

Lemma 4.13. *Let $\beta_1, \dots, \beta_\nu$ be $\nu \geq 1$ integers with $\beta_t > 1, \forall t, 1 \leq t \leq \nu$ and $\mu \in \{1, \dots, \nu\}$. Then the diophantine equation:*

$$(4.38) \quad \mu \left(\prod_{t=1}^{\nu} \beta_t \right) = \sum_{t=1}^{\nu} \left(\prod_{\substack{i=1 \\ i \neq t}}^{\nu} \beta_i \right)$$

has no solution for $\nu < 2\mu$.

Proof. (4.38) is equivalent to $\sum_{t=1}^{\nu} \frac{1}{\beta_t} = \mu$. Without loss of generality, we may assume that β_1 is the smallest number among all β_t 's. Then $\beta_1 \leq \frac{\nu}{\mu}$, i.e. $\beta_1 \leq 1 + \frac{\nu-\mu}{\mu}$. The assumption of the existence of a solution of (4.38) for $\nu < 2\mu$ would therefore imply $\beta_1 < 2$, which would lead to a contradiction. \square

Proof of 4.12. At first we have to determine all combinations of weights $\mathbf{w} = (w_1, \dots, w_m)$ and degrees $\mathbf{d} = (d_1, \dots, d_k)$ for which

$$(4.39) \quad \sum_{i=1}^m w_i = \sum_{j=1}^k d_j$$

holds true.

1st case: Let $X_{\mathbf{d}}$ be a *Fermat type*, i.e. $d_1 = \dots = d_k := d$. In this case we set $a_i := \frac{d}{w_i} = \alpha_{ij}$. (4.39) can be rewritten as

$$(4.40) \quad \sum_{i=1}^m \frac{1}{a_i} = k$$

Since $a_i > 1, \forall i, 1 \leq i \leq m$, (4.40) has no solution for $k > m - k = 4$ (by 4.13.), i.e. $k \in \{1, 2, 3, 4\}$. We order now a_1, \dots, a_m as follows:

$$a_1 = \dots = a_{\xi_1} < a_{\xi_1+1} = \dots = a_{\xi_2} < \dots < a_{\xi_{r-1}+1} = \dots = a_{\xi_r},$$

where $r \in \{1, \dots, m\}$, $\xi_0 := 0$ and $\xi_r = k + 4$. If $q_t := \xi_t - \xi_{t-1} > 0$ for $t = 1, \dots, r$, equation (4.40) can be written as

$$(4.41) \quad \sum_{t=1}^r \frac{q_t}{a_{\xi_t}} = k \quad \text{with}$$

$$(4.42) \quad \sum_{t=1}^r q_t = m = k + 4.$$

(i) For $r = 1 \Rightarrow a_1 = \dots = a_m =: a$, $w_1 = \dots = w_m = 1$ and $(a - 1)k = 4$, i.e. $(k, a) \in \{(1, 5), (2, 3), (4, 2)\}$.

(ii) If $2 \leq r \leq m$, we set $k_0 := k$, $k_1 := \frac{q_1}{a_{\xi_1}}$ and

$$k_\tau := k - \sum_{v=1}^{\tau} \frac{q_v}{a_{\xi_v}} = \sum_{\sigma=\tau+1}^r \frac{q_\sigma}{a_{\xi_\sigma}} = k_{\tau-1} - \frac{q_\tau}{a_{\xi_\tau}}, \quad \tau \in \{1, \dots, r-1\}.$$

$\{k_\tau | 0 \leq \tau \leq r-1\}$ is a finite decreasing sequence of natural numbers. For $k \in \{1, 2, 3, 4\}$ we choose an $a_1 = a_{\xi_1}$ from the interval $2 \leq a_1 \leq \frac{m}{k}$ and an arbitrary natural number q_1 which occurs in the partition (4.42). Then we can determine iteratively all combinations of r -tuples $(a_{\xi_1}, \dots, a_{\xi_r})$, (q_1, \dots, q_r) , which satisfy the inequalities:

$$(4.43) \quad \left\{ \begin{array}{l} 2 \leq a_{\xi_1} \leq \frac{m}{k} \\ a_{\xi_1+1} \leq a_{\xi_2} \leq \frac{m - q_1}{k_1} \\ \dots\dots\dots \\ a_{\xi_{r-2}+1} \leq a_{\xi_{r-1}} \leq \frac{m - q_1 - q_2 - \dots - q_{r-2}}{k_{r-2}} \\ a_{\xi_{r-1}+1} \leq a_{\xi_r} \leq \frac{m - q_1 - q_2 - \dots - q_{r-1}}{k_{r-1}} \end{array} \right.$$

It is easy to see that q_1, \dots, q_r have the following bounds:

$$(4.44) \quad \left\{ \begin{array}{l} a_{\xi_1} \{k(a_{\xi_1} + 1) - m\} \leq q_1 \leq k a_{\xi_1} \\ a_{\xi_2} \{k_1(a_{\xi_2} + 1) - (m - q_1)\} \leq q_2 \leq k_1 a_{\xi_2} \\ \dots\dots\dots \\ a_{\xi_{r-1}} \{k_{r-2}(a_{\xi_{r-1}} + 1) - (m - q_1 - \dots - q_{r-2})\} \leq q_{r-1} \leq k_{r-2} a_{\xi_{r-1}} \\ a_{\xi_r} \{k_{r-1}(a_{\xi_r} + 1) - (m - q_1 - \dots - q_{r-1})\} \leq q_r \leq k_{r-1} a_{\xi_r} \end{array} \right.$$

The system of (4.41), (4.42), (4.43) and (4.44) can be solved by this algorithm and leads to 146 solutions for $k = 1$, 17 solutions for $k = 2$, 3 solutions for $k = 3$, and no solution for $k = 4$ respectively. (The computer aided verification of this fact is due to A. Klemm.)

2d case: (Not all degrees are equal and $k \geq 2$.) Since $w_i | d_j, \forall i, 1 \leq i \leq m, \forall j, 1 \leq j \leq k$, we have in this case $w_i | \gcd(d_1, \dots, d_k), \forall i, 1 \leq i \leq m$.

(i) If $\gcd(d_1, \dots, d_k) = 1 \implies w_1 = \dots = w_m = 1$ and (4.39) has only one solution (up to permutations of degrees), namely $(k = 3, d_1 = 2, d_2 = 2, d_3 = 3)$.

(ii) If $\gcd(d_1, \dots, d_k) > 1$, we set $e_j := \frac{d_j}{\gcd(d_1, \dots, d_k)}, \forall j, 1 \leq j \leq k$.

Obviously,

$$(4.45) \quad \sum_{j=1}^k e_j \in \{k, k+1, k+2, k+3, k+4\}, \gcd(e_1, \dots, e_k) = 1.$$

Thus, (4.39) can be rewritten as:

$$(4.46) \quad 1 + \frac{1}{e_j} \left(\sum_{\substack{s=1 \\ s \neq j}}^k e_s \right) = \sum_{i=1}^m \frac{1}{\alpha_{ij}}, \forall j, 1 \leq j \leq k.$$

(a) From (4.45) we exclude the case in which $\sum_{j=1}^k e_j = k$, because $X_{\mathbf{d}}$ is assumed to be of non-Fermat type.

(b) If $\sum_{j=1}^k e_j = k+1$, then one of the e_j 's equals 2 and all the other = 1. Setting, for instance, $e_1 = 2, e_2 = \dots = e_k = 1$, we have $\frac{d_1}{2} = d_2 = \dots = d_k$ and (4.46) can be reduced to $\sum_{i=1}^m \frac{1}{\alpha_{ij}} = k+1, \forall j, 2 \leq j \leq k$.

According to our lemma 4.13, this equation has no solution for $k > 2$, but for $k = 2$ we get $\alpha_{i2} = 2$ and $\alpha_{i1} = 4, \forall i, 1 \leq i \leq 6$. Hence, the only solution that can occur (up to permutation of degrees) is $(k = 2, d_1 = 4, d_2 = 2, w_1 = \dots = w_6 = 1)$.

(c) If $\sum_{j=1}^k e_j = k+2$, then the set $\{e_1, \dots, e_k\}$ equals either

$$\underbrace{\{1, 1, \dots, 1, 3\}}_{(k-1)\text{-times}} \quad (k \geq 1)$$

or

$$\underbrace{\{1, \dots, 1, 2, 2\}}_{(k-2)\text{-times}} \quad (k \geq 3)$$

and (4.46) has no solution by 4.13.

(d) The remaining two cases can be investigated similarly. Applying lemma 4.13.

several times, we conclude that (up to permutations of degrees and weights) (4.46) has one more solution for $k = 2$, namely $(k = 2, d_1 = 4, d_2 = 6, w_1 = \dots = w_4 = 2, w_5 = w_6 = 1)$, but no further solution for $k > 2$.

The proof of the proposition is completed by making use of the “weighted Bézout’s theorem” (for the formulae of λ and μ , cf. 4.7. (ii)), of lemmata 4.1. and 4.2. (for the determination of the types of the points of $\text{Sing}(X)$), and of the precise placing of the exceptional prime divisors on the toric triangles lying over the dissident points of X (for finding out which of the Y ’s are indeed unique). \square

Table 1: The $k = 1$ case

N^0	$X = X_d \subset \mathbb{P}^4(\mathbf{w})$	κ	λ	μ	$e(X)$	$e(Y)$	$b_3(X)$	$b_3(Y)$	$h^{1,2}(Y)$	$h^{1,1}(Y)$
1	$**X_5 \subset \mathbb{P}^4(1, 1, 1, 1, 1)$	0	0	0	-200	-200	204	204	101	1
2	$**X_6 \subset \mathbb{P}^4(1, 1, 1, 1, 2)$	0	0	0	-204	-204	208	208	103	1
3	$*X_8 \subset \mathbb{P}^4(1, 1, 2, 2, 2)$	1	0	0	-164	-168	168	174	86	2
4	$**X_8 \subset \mathbb{P}^4(1, 1, 1, 1, 4)$	0	0	0	-296	-296	300	300	149	1
5	$*X_9 \subset \mathbb{P}^4(1, 1, 1, 3, 3)$	0	3	0	-222	-216	226	226	112	4
6	$**X_{10} \subset \mathbb{P}^4(1, 1, 1, 2, 5)$	0	0	0	-288	-288	292	292	145	1
7	$*X_{12} \subset \mathbb{P}^4(2, 2, 2, 3, 3)$	1	4	0	-98	-108	102	122	60	6
8	$*X_{12} \subset \mathbb{P}^4(1, 2, 3, 3, 3)$	1	0	0	-124	-132	128	140	69	3
9	$*X_{12} \subset \mathbb{P}^4(1, 2, 2, 3, 4)$	1	0	0	-138	-144	142	150	74	2
10	$*X_{12} \subset \mathbb{P}^4(1, 1, 3, 3, 4)$	0	4	0	-176	-168	180	180	89	5
11	$*X_{12} \subset \mathbb{P}^4(1, 1, 2, 4, 4)$	1	0	3	-198	-192	202	204	101	5
12	$*X_{12} \subset \mathbb{P}^4(1, 1, 2, 2, 6)$	1	0	0	-250	-252	254	258	128	2
13	$*X_{12} \subset \mathbb{P}^4(1, 1, 1, 3, 6)$	0	2	0	-328	-324	332	332	165	3
14	$*X_{14} \subset \mathbb{P}^4(1, 2, 2, 2, 7)$	1	0	0	-212	-240	216	246	122	2
15	$*X_{15} \subset \mathbb{P}^4(1, 3, 3, 3, 5)$	1	0	0	-124	-144	128	152	75	3
16	$*X_{15} \subset \mathbb{P}^4(1, 1, 3, 5, 5)$	0	3	0	-204	-192	208	208	103	7
17	$*X_{16} \subset \mathbb{P}^4(1, 1, 2, 4, 8)$	1	0	2	-292	-288	296	298	148	4
18	$X_{18} \subset \mathbb{P}^4(1, 2, 3, 6, 6)$	2	0	3	-150	-144	154	160	79	7
19	$*X_{18} \subset \mathbb{P}^4(1, 2, 3, 3, 9)$	1	0	0	-188	-192	192	200	99	3
20	$*X_{18} \subset \mathbb{P}^4(2, 2, 2, 3, 9)$	1	2	0	-166	-216	170	226	112	4
21	$*X_{18} \subset \mathbb{P}^4(1, 1, 1, 6, 9)$	0	1	0	-542	-540	546	546	272	2
22	$*X_{20} \subset \mathbb{P}^4(2, 4, 4, 5, 5)$	1	4	5	-64	-48	68	80	39	15
23	$*X_{20} \subset \mathbb{P}^4(1, 4, 5, 5, 5)$	1	0	0	-104	-120	108	132	65	5
24	$*X_{20} \subset \mathbb{P}^4(1, 2, 2, 5, 10)$	1	2	0	-230	-228	234	242	120	6
25	$*X_{20} \subset \mathbb{P}^4(1, 1, 4, 4, 10)$	1	0	5	-284	-272	288	288	143	7
26	$*X_{21} \subset \mathbb{P}^4(1, 3, 3, 7, 7)$	0	10	0	-128	-96	132	132	65	17
27	$*X_{24} \subset \mathbb{P}^4(2, 3, 3, 8, 8)$	1	8	3	-82	-48	86	88	43	19
28	$*X_{24} \subset \mathbb{P}^4(3, 3, 4, 6, 8)$	2	0	3	-70	-96	74	112	55	7
29	$X_{24} \subset \mathbb{P}^4(1, 3, 4, 8, 8)$	1	0	3	-132	-120	136	142	70	10
30	$X_{24} \subset \mathbb{P}^4(1, 3, 6, 6, 8)$	2	0	4	-122	-120	126	138	68	8
31	$*X_{24} \subset \mathbb{P}^4(2, 3, 3, 4, 12)$	2	0	2	-114	-120	118	134	66	6
32	$*X_{24} \subset \mathbb{P}^4(1, 3, 4, 4, 12)$	1	2	0	-166	-168	170	182	90	6
33	$X_{24} \subset \mathbb{P}^4(1, 2, 3, 6, 12)$	2	0	2	-220	-216	224	230	114	6
34	$*X_{24} \subset \mathbb{P}^4(1, 1, 6, 8, 8)$	1	0	3	-260	-240	264	264	131	11
35	$*X_{24} \subset \mathbb{P}^4(1, 1, 4, 6, 12)$	1	0	4	-326	-312	330	330	164	8
36	$*X_{24} \subset \mathbb{P}^4(1, 1, 2, 8, 12)$	1	0	1	-482	-480	486	488	243	3
37	$*X_{28} \subset \mathbb{P}^4(1, 2, 4, 7, 14)$	1	2	0	-224	-216	228	234	116	8
38	$X_{30} \subset \mathbb{P}^4(3, 5, 6, 6, 10)$	2	3	5	-52	-48	56	80	39	15
39	$X_{30} \subset \mathbb{P}^4(2, 3, 5, 10, 10)$	2	0	3	-84	-72	88	98	48	12
40	$X_{30} \subset \mathbb{P}^4(1, 3, 6, 10, 10)$	1	5	3	-132	-96	136	136	67	19

N^0	$X = X_d \subset \mathbb{P}^4(\mathbf{w})$	κ	λ	μ	$e(X)$	$e(Y)$	$b_3(X)$	$b_3(Y)$	$h^{1,2}(Y)$	$h^{1,1}(Y)$
41	* $X_{30} \subset \mathbb{P}^4(2, 3, 5, 5, 15)$	1	2	0	-104	-108	108	124	61	7
42	* $X_{30} \subset \mathbb{P}^4(1, 3, 5, 6, 15)$	1	2	0	-172	-168	176	184	91	7
43	* $X_{30} \subset \mathbb{P}^4(2, 2, 5, 6, 15)$	1	3	0	-152	-192	156	208	103	7
44	$X_{30} \subset \mathbb{P}^4(1, 2, 6, 6, 15)$	2	0	5	-220	-216	224	236	117	9
45	* $X_{30} \subset \mathbb{P}^4(1, 2, 2, 10, 15)$	1	1	0	-388	-408	392	418	208	4
46	* $X_{30} \subset \mathbb{P}^4(1, 1, 3, 10, 15)$	0	3	0	-500	-492	504	504	251	5
47	$X_{36} \subset \mathbb{P}^4(2, 4, 9, 9, 12)$	2	0	7	-70	-48	74	88	43	19
48	$X_{36} \subset \mathbb{P}^4(2, 3, 4, 9, 18)$	2	0	2	-126	-120	130	142	70	10
49	* $X_{36} \subset \mathbb{P}^4(1, 4, 4, 9, 18)$	1	2	9	-180	-144	184	184	91	19
50	$X_{36} \subset \mathbb{P}^4(1, 2, 9, 12, 12)$	2	0	3	-196	-168	200	202	100	16
51	$X_{36} \subset \mathbb{P}^4(1, 2, 6, 9, 18)$	2	0	4	-246	-228	250	254	126	12
52	$X_{36} \subset \mathbb{P}^4(1, 2, 3, 12, 18)$	2	0	1	-362	-360	366	372	185	5
53	* $X_{36} \subset \mathbb{P}^4(1, 1, 4, 12, 18)$	1	0	4	-540	-528	544	544	271	7
54	* $X_{40} \subset \mathbb{P}^4(2, 5, 5, 8, 20)$	2	0	1	-96	-112	100	128	63	7
55	$X_{40} \subset \mathbb{P}^4(1, 4, 5, 10, 20)$	2	0	4	-182	-168	186	194	96	12
56	* $X_{40} \subset \mathbb{P}^4(1, 1, 8, 10, 20)$	1	0	3	-452	-432	456	456	227	11
57	$X_{42} \subset \mathbb{P}^4(2, 6, 6, 7, 21)$	2	2	7	-98	-96	102	132	65	17
58	$X_{42} \subset \mathbb{P}^4(1, 6, 7, 14, 14)$	2	0	3	-116	-96	120	132	65	17
59	* $X_{42} \subset \mathbb{P}^4(1, 6, 7, 7, 21)$	1	1	0	-146	-156	150	174	86	8
60	* $X_{42} \subset \mathbb{P}^4(2, 2, 3, 14, 21)$	1	3	0	-262	-288	266	304	151	7
61	* $X_{42} \subset \mathbb{P}^4(1, 3, 3, 14, 21)$	1	1	0	-334	-348	338	362	180	6
62	$X_{45} \subset \mathbb{P}^4(1, 5, 9, 15, 15)$	2	0	3	-124	-96	128	136	67	19
63	$X_{48} \subset \mathbb{P}^4(1, 3, 12, 16, 16)$	1	4	3	-170	-120	174	174	86	26
64	$X_{48} \subset \mathbb{P}^4(1, 3, 8, 12, 24)$	2	0	4	-218	-192	222	226	112	16
65	* $X_{48} \subset \mathbb{P}^4(2, 3, 3, 16, 24)$	2	0	1	-222	-240	226	256	127	7
66	$X_{48} \subset \mathbb{P}^4(1, 3, 4, 16, 24)$	1	2	1	-320	-312	324	330	164	8
67	* $X_{48} \subset \mathbb{P}^4(1, 1, 6, 16, 24)$	1	0	3	-640	-624	644	644	321	9
68	$X_{54} \subset \mathbb{P}^4(1, 2, 6, 18, 27)$	2	0	4	-412	-408	416	430	214	10
69	$X_{60} \subset \mathbb{P}^4(3, 5, 12, 20, 20)$	2	5	3	-52	0	56	64	31	31
70	$X_{60} \subset \mathbb{P}^4(4, 6, 15, 15, 20)$	3	0	7	-40	0	44	56	27	27
71	$X_{60} \subset \mathbb{P}^4(2, 3, 15, 20, 20)$	2	4	3	-106	-48	110	112	55	31
72	$X_{60} \subset \mathbb{P}^4(1, 12, 12, 15, 20)$	2	1	5	-92	-48	96	96	47	23
73	$X_{60} \subset \mathbb{P}^4(4, 5, 6, 15, 30)$	3	0	4	-70	-48	74	86	42	18
74	$X_{60} \subset \mathbb{P}^4(3, 10, 12, 15, 20)$	3	0	4	-44	-48	48	80	39	15
75	$X_{60} \subset \mathbb{P}^4(3, 5, 10, 12, 30)$	3	0	3	-72	-72	76	100	49	13
76	$X_{60} \subset \mathbb{P}^4(2, 3, 10, 15, 30)$	3	0	4	-138	-108	142	150	74	20
77	$X_{60} \subset \mathbb{P}^4(1, 4, 15, 20, 20)$	2	0	3	-164	-120	168	174	86	26
78	$X_{60} \subset \mathbb{P}^4(1, 5, 12, 12, 30)$	1	2	5	-168	-120	172	172	85	25
79	$X_{60} \subset \mathbb{P}^4(1, 4, 10, 15, 30)$	2	0	4	-204	-168	208	210	104	20

N^0	$X = X_d \subset \mathbb{P}^4(\mathbf{w})$	κ	λ	μ	$e(X)$	$e(Y)$	$b_3(X)$	$b_3(Y)$	$h^{1,2}(Y)$	$h^{1,1}(Y)$
80	$X_{60} \subset \mathbb{P}^4(3, 3, 4, 20, 30)$	2	0	4	-176	-192	180	216	107	11
81	$X_{60} \subset \mathbb{P}^4(2, 3, 5, 20, 30)$	2	2	1	-200	-192	204	214	106	10
82	$X_{60} \subset \mathbb{P}^4(1, 4, 5, 20, 30)$	2	0	4	-300	-288	304	312	155	11
83	$X_{60} \subset \mathbb{P}^4(1, 2, 12, 15, 30)$	2	0	3	-340	-312	344	348	173	17
84	$X_{60} \subset \mathbb{P}^4(1, 3, 6, 20, 30)$	2	0	3	-338	-336	342	358	178	10
85	$X_{66} \subset \mathbb{P}^4(2, 3, 6, 22, 33)$	2	1	0	-216	-240	220	260	129	9
86	$X_{70} \subset \mathbb{P}^4(2, 5, 14, 14, 35)$	2	2	5	-104	-64	108	120	59	27
87	$X_{70} \subset \mathbb{P}^4(1, 10, 10, 14, 35)$	2	1	7	-140	-96	144	144	71	23
88	$X_{72} \subset \mathbb{P}^4(1, 8, 9, 18, 36)$	2	0	3	-164	-144	168	184	91	19
89	$X_{72} \subset \mathbb{P}^4(1, 3, 8, 24, 36)$	2	0	4	-360	-336	364	368	183	15
90	$X_{72} \subset \mathbb{P}^4(1, 2, 9, 24, 36)$	2	0	3	-480	-456	484	486	242	14
91	$X_{78} \subset \mathbb{P}^4(1, 6, 6, 26, 39)$	2	1	13	-284	-240	288	288	143	23
92	$X_{84} \subset \mathbb{P}^4(3, 4, 21, 28, 28)$	2	4	3	-74	0	78	84	41	41
93	$X_{84} \subset \mathbb{P}^4(2, 12, 21, 21, 28)$	3	0	5	-56	0	60	72	35	35
94	$X_{84} \subset \mathbb{P}^4(3, 4, 14, 21, 42)$	3	0	4	-96	-48	100	106	52	28
95	$X_{84} \subset \mathbb{P}^4(1, 6, 21, 28, 28)$	2	2	3	-150	-72	154	154	76	40
96	$X_{84} \subset \mathbb{P}^4(2, 7, 12, 21, 42)$	3	0	3	-98	-72	102	120	59	23
97	$X_{84} \subset \mathbb{P}^4(3, 4, 7, 28, 42)$	2	2	4	-138	-120	142	154	76	16
98	$X_{84} \subset \mathbb{P}^4(1, 6, 14, 21, 42)$	3	0	6	-190	-132	194	194	96	30
99	$X_{84} \subset \mathbb{P}^4(1, 6, 7, 28, 42)$	2	0	3	-280	-264	284	296	147	15
100	* $X_{84} \subset \mathbb{P}^4(1, 1, 12, 28, 42)$	1	0	3	-980	-960	984	984	491	11
101	$X_{90} \subset \mathbb{P}^4(2, 10, 15, 18, 45)$	3	0	3	-92	-96	96	136	67	19
102	$X_{90} \subset \mathbb{P}^4(2, 3, 10, 30, 45)$	3	0	4	-232	-216	236	254	126	18
103	$X_{90} \subset \mathbb{P}^4(1, 5, 9, 30, 45)$	2	0	3	-300	-276	304	312	155	17
104	$X_{96} \subset \mathbb{P}^4(1, 3, 12, 32, 48)$	2	0	3	-430	-408	434	446	222	18
105	$X_{100} \subset \mathbb{P}^4(1, 4, 20, 25, 50)$	2	0	8	-280	-216	284	284	141	33
106	$X_{110} \subset \mathbb{P}^4(1, 10, 22, 22, 55)$	2	1	5	-156	-80	160	160	79	39
107	$X_{120} \subset \mathbb{P}^4(1, 15, 24, 40, 40)$	2	1	3	-108	0	112	112	55	55
108	$X_{120} \subset \mathbb{P}^4(1, 15, 20, 24, 60)$	3	0	5	-136	-72	140	140	69	33
109	$X_{120} \subset \mathbb{P}^4(3, 5, 12, 40, 60)$	3	0	3	-138	-120	142	166	82	22
110	$X_{120} \subset \mathbb{P}^4(1, 5, 24, 30, 60)$	2	0	3	-272	-216	276	284	141	33
111	$X_{120} \subset \mathbb{P}^4(2, 3, 15, 40, 60)$	3	0	3	-270	-240	274	288	143	23
112	$X_{120} \subset \mathbb{P}^4(1, 4, 15, 40, 60)$	2	0	3	-400	-360	404	410	204	24
113	$X_{126} \subset \mathbb{P}^4(1, 6, 14, 42, 63)$	3	0	7	-316	-264	320	322	160	28
114	$X_{126} \subset \mathbb{P}^4(1, 2, 18, 42, 63)$	2	0	3	-740	-720	744	756	377	17
115	$X_{140} \subset \mathbb{P}^4(1, 14, 20, 35, 70)$	3	0	5	-158	-72	162	162	80	44
116	$X_{140} \subset \mathbb{P}^4(2, 5, 28, 35, 70)$	3	0	3	-160	-96	164	176	87	39
117	$X_{156} \subset \mathbb{P}^4(1, 12, 39, 52, 52)$	2	1	3	-140	0	144	144	71	71
118	$X_{156} \subset \mathbb{P}^4(1, 12, 26, 39, 78)$	3	0	5	-176	-72	180	180	89	53
119	$X_{156} \subset \mathbb{P}^4(1, 12, 13, 52, 78)$	2	0	3	-260	-240	264	288	143	23

N^0	$X = X_d \subset \mathbb{P}^4(\mathbf{w})$	κ	λ	μ	$e(X)$	$e(Y)$	$b_3(X)$	$b_3(Y)$	$h^{1,2}(Y)$	$h^{1,1}(Y)$
120	$X_{168} \subset \mathbb{P}^4(3, 4, 21, 56, 84)$	3	0	3	-190	-144	194	212	105	33
121	$X_{168} \subset \mathbb{P}^4(1, 6, 21, 56, 84)$	3	0	5	-374	-312	378	382	190	34
122	$X_{168} \subset \mathbb{P}^4(1, 3, 24, 56, 84)$	2	0	3	-656	-624	660	672	335	23
123	$X_{180} \subset \mathbb{P}^4(4, 5, 36, 45, 90)$	3	0	8	-100	0	104	112	55	55
124	$X_{180} \subset \mathbb{P}^4(1, 9, 20, 60, 90)$	2	0	6	-298	-216	302	302	150	42
125	$X_{198} \subset \mathbb{P}^4(2, 9, 22, 66, 99)$	3	0	6	-170	-96	174	188	93	45
126	$X_{210} \subset \mathbb{P}^4(6, 14, 15, 70, 105)$	4	0	6	-64	0	68	88	43	43
127	$X_{210} \subset \mathbb{P}^4(2, 3, 30, 70, 105)$	3	0	3	-416	-384	420	444	221	29
128	$X_{216} \subset \mathbb{P}^4(1, 8, 27, 72, 108)$	2	0	6	-358	-264	362	362	180	48
129	$X_{220} \subset \mathbb{P}^4(1, 10, 44, 55, 110)$	3	0	5	-248	-120	252	252	125	65
130	$X_{240} \subset \mathbb{P}^4(1, 15, 24, 80, 120)$	3	0	5	-266	-168	270	270	134	50
131	$X_{264} \subset \mathbb{P}^4(3, 8, 33, 88, 132)$	3	0	6	-148	-48	152	164	81	57
132	$X_{294} \subset \mathbb{P}^4(1, 6, 42, 98, 147)$	3	0	10	-572	-480	576	576	287	47
133	$X_{312} \subset \mathbb{P}^4(1, 12, 39, 104, 156)$	3	0	5	-346	-216	350	350	174	66
134	$X_{330} \subset \mathbb{P}^4(3, 22, 30, 110, 165)$	4	0	6	-96	0	100	120	59	59
135	$X_{336} \subset \mathbb{P}^4(1, 7, 48, 112, 168)$	2	0	3	-560	-480	564	576	287	47
136	$X_{342} \subset \mathbb{P}^4(1, 18, 38, 114, 171)$	3	0	6	-284	-144	288	288	143	71
137	$X_{378} \subset \mathbb{P}^4(2, 7, 54, 126, 189)$	3	0	3	-320	-240	324	348	173	53
138	$X_{420} \subset \mathbb{P}^4(1, 20, 84, 105, 210)$	3	0	5	-236	0	240	240	119	119
139	$X_{420} \subset \mathbb{P}^4(3, 7, 60, 140, 210)$	3	0	3	-236	-144	240	264	131	59
140	$X_{462} \subset \mathbb{P}^4(2, 33, 42, 154, 231)$	4	0	5	-136	0	140	160	79	79
141	$X_{546} \subset \mathbb{P}^4(6, 7, 78, 182, 273)$	4	0	10	-152	0	156	168	83	83
142	$X_{600} \subset \mathbb{P}^4(1, 24, 75, 200, 300)$	3	0	5	-332	-96	336	336	167	119
143	$X_{630} \subset \mathbb{P}^4(1, 14, 90, 210, 315)$	3	0	6	-524	-336	528	528	263	95
144	$X_{714} \subset \mathbb{P}^4(3, 14, 102, 238, 357)$	4	0	6	-200	0	204	216	107	107
145	$X_{924} \subset \mathbb{P}^4(1, 21, 132, 308, 462)$	3	0	5	-512	-240	516	516	257	137
146	$X_{966} \subset \mathbb{P}^4(2, 21, 138, 322, 483)$	4	0	5	-272	0	276	288	143	143
147	$X_{1806} \subset \mathbb{P}^4(1, 42, 258, 602, 903)$	4	0	6	-500	0	504	504	251	251

148	** $X_{(3,3)} \subset \mathbb{P}^5(1, 1, 1, 1, 1, 1)$	0	0	0	-144	-144	148	148	73	1
149	** $X_{(2,4)} \subset \mathbb{P}^5(1, 1, 1, 1, 1, 1)$	0	0	0	-176	-176	180	180	89	1
150	** $X_{(4,4)} \subset \mathbb{P}^5(1, 1, 1, 1, 2, 2)$	0	0	0	-144	-144	148	148	73	1
151	* $X_{(4,6)} \subset \mathbb{P}^5(1, 1, 2, 2, 2, 2)$	1	0	0	-126	-132	130	138	68	2
152	* $X_{(6,6)} \subset \mathbb{P}^5(1, 1, 1, 3, 3, 3)$	0	4	0	-152	-144	156	156	77	5
153	** $X_{(6,6)} \subset \mathbb{P}^5(1, 1, 2, 2, 3, 3)$	0	0	0	-120	-120	124	124	61	1
154	* $X_{(6,6)} \subset \mathbb{P}^5(1, 2, 2, 2, 2, 3)$	1	0	0	-102	-120	106	126	62	2
155	* $X_{(8,8)} \subset \mathbb{P}^5(1, 1, 2, 4, 4, 4)$	1	0	4	-136	-128	140	142	70	6
156	* $X_{(10,10)} \subset \mathbb{P}^5(1, 2, 2, 5, 5, 5)$	0	4	0	-104	-88	108	108	53	9
157	* $X_{(12,12)} \subset \mathbb{P}^5(1, 1, 4, 6, 6, 6)$	1	0	4	-150	-132	154	154	76	10
158	$X_{(12,12)} \subset \mathbb{P}^5(1, 2, 3, 6, 6, 6)$	2	0	4	-104	-96	108	114	56	8
159	* $X_{(12,12)} \subset \mathbb{P}^5(1, 3, 4, 4, 6, 6)$	1	4	0	-78	-72	82	86	42	6
160	* $X_{(12,12)} \subset \mathbb{P}^5(3, 3, 4, 4, 4, 6)$	1	8	9	-34	0	38	40	19	19
161	* $X_{(12,12)} \subset \mathbb{P}^5(2, 3, 3, 4, 6, 6)$	2	0	0	-62	-84	66	94	46	4
162	$X_{(18,18)} \subset \mathbb{P}^5(1, 2, 6, 9, 9, 9)$	1	0	4	-112	-84	116	116	57	15
163	$X_{(20,20)} \subset \mathbb{P}^5(1, 4, 5, 10, 10, 10)$	2	0	4	-86	-68	90	98	48	14
164	$X_{(24,24)} \subset \mathbb{P}^5(1, 3, 8, 12, 12, 12)$	2	0	4	-102	-72	106	110	54	18
165	$X_{(30,30)} \subset \mathbb{P}^5(2, 3, 10, 15, 15, 15)$	2	0	4	-64	-24	68	72	35	23
166	$X_{(42,42)} \subset \mathbb{P}^5(1, 6, 14, 21, 21, 21)$	2	0	4	-88	-24	92	92	45	33
167	** $X_{(2,2,3)} \subset \mathbb{P}^6(1, 1, 1, 1, 1, 1, 1)$	0	0	0	-144	-144	148	148	73	1
168	* $X_{(4,4,4)} \subset \mathbb{P}^6(1, 1, 2, 2, 2, 2, 2)$	1	0	0	-104	-112	108	118	58	2
169	* $X_{(6,6,6)} \subset \mathbb{P}^6(1, 2, 3, 3, 3, 3, 3)$	1	0	0	-80	-96	84	104	51	3
170	* $X_{(6,6,6)} \subset \mathbb{P}^6(2, 2, 2, 3, 3, 3, 3)$	0	8	0	-52	-36	56	56	27	9
171	** $X_{(2,2,2,2)} \subset \mathbb{P}^7$	0	0	0	-128	-128	132	132	65	1

Example 4.14. Let us explain by an example how the configuration of the exceptional prime divisors in a crepant toroidal desingularization becomes “visible”. If we take $X = X_{(30,30)} \subset \mathbb{P}^5(2, 3, 10, 15, 15, 15)$ to be the Fermat 165th CY model of Table 1, then $\text{Sing}(X) = C_1 \cup C_2$ is the union of a rational curve $C_1 := X_{\{1,2\}}$ and an elliptic curve $C_2 := X_{\{1,3\}}$ with $C_1 \cap C_2 = \{P_1, P_2, P_3, P_4\}$ composed of four common individual points. It is easy to verify by (4.36) and (4.37) that

$$(X, P) \cong \begin{cases} (C \times (C^2 / \langle \text{diag}(\zeta_5^2, \zeta_5^3), \{0\} \times \{0\} \rangle), & \text{if } P \in C_1 \setminus \{P_1, P_2, P_3, P_4\} \\ (C \times (C^2 / \langle \text{diag}(\zeta_3^2, \zeta_3), \{0\} \times \{0\} \rangle), & \text{if } P \in C_2 \setminus \{P_1, P_2, P_3, P_4\} \\ (C^3 / \langle \text{diag}(\zeta_{15}^2, \zeta_{15}^3, \zeta_{15}^{10}), \{0\} \rangle), & \text{if } P \in \{P_1, P_2, P_3, P_4\} \end{cases}$$

and that our formulae give: $e(X) = -64$, $e(Y) = -24$, $h^{1,1}(Y) = 1+2+4+4 = 23$,

$b_3(Y) = 68 + 4 \cdot 0 + 2 \cdot 2 = 72$, for every crepant toroidal desingularization space Y of X . Using, for instance, for a point P_j , $j \in \{1, 2, 3, 4\}$, the local crepant toric desingularization being depicted in fig. 4, we can recognize promptly (by § 3) what kind of exceptional prime divisors are contained in \mathcal{E}_{P_j} . (They are all Hirzebruch surfaces blown up at 0, 2 or 3 points.) Figure 5 shows the corresponding *global* configuration of the members of the exceptional locus near P_j .

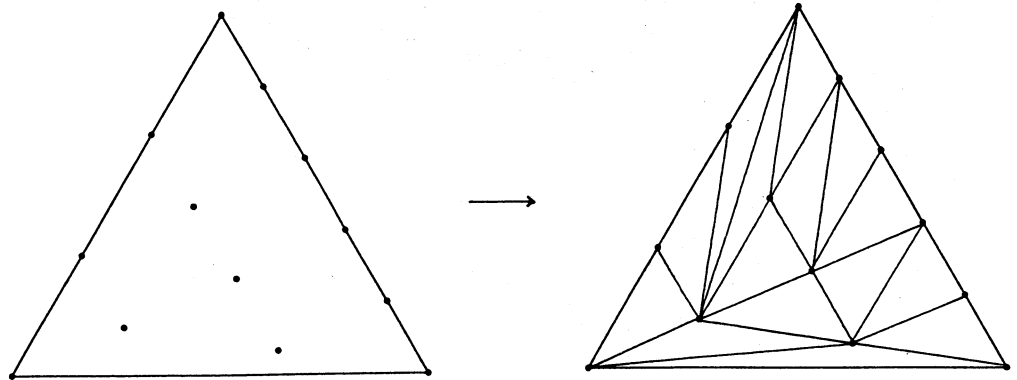

Fig. 4

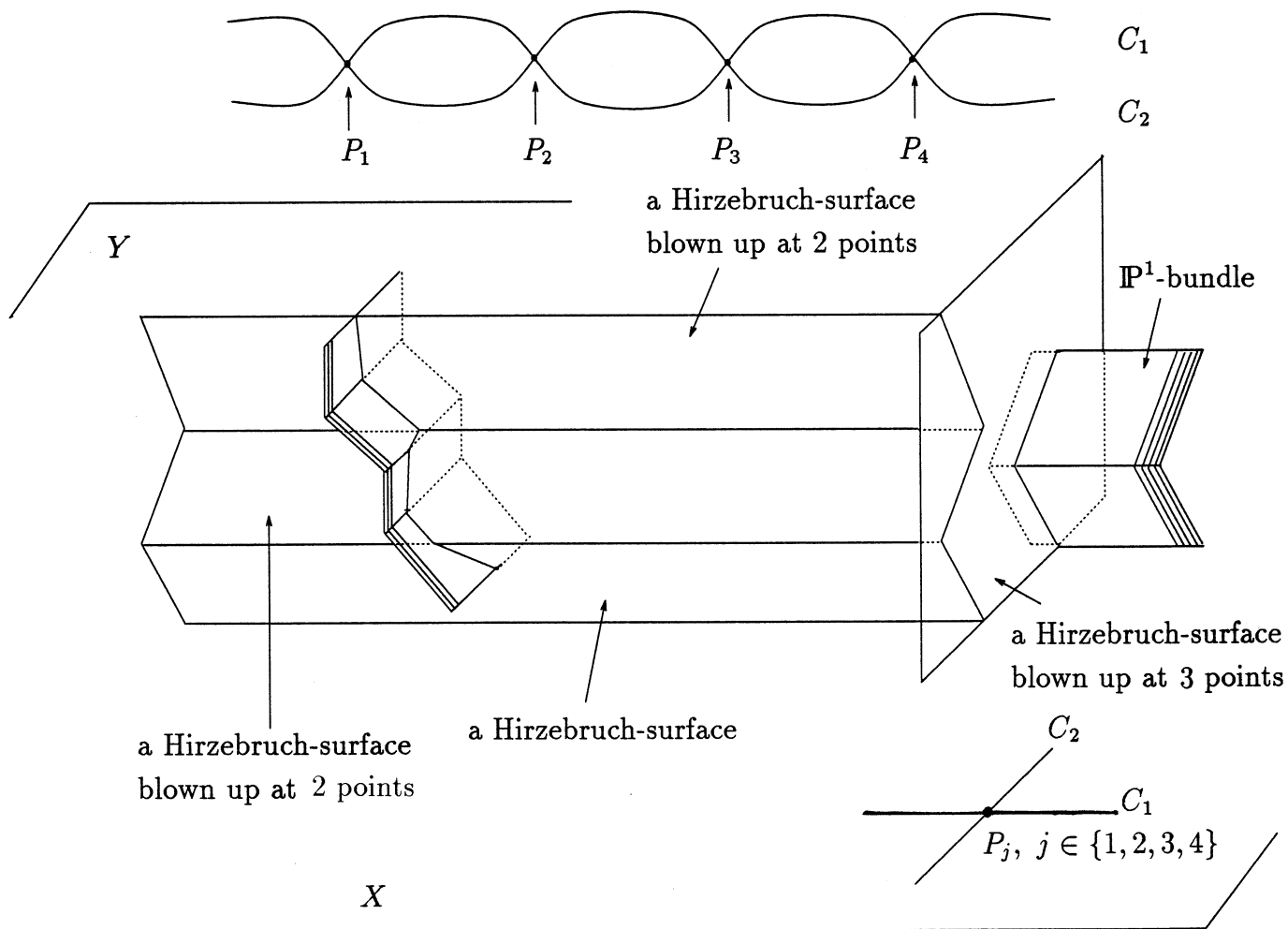

Fig. 5

Remark 4.15. The formulae of theorem 4.11. are also applicable to that complete intersections of Brieskorn-Pham type, which become overall well-stratified after a suitable rearrangement of their defining polynomials. If we consider, for example, $f_1(z_1, \dots, z_6) = z_1^2 + 2z_2^3 + 3z_3^3 + \sum_{i=4}^6 i z_i^6$, $f_2(z_1, \dots, z_6) = z_2^2 + z_3^2 + \sum_{i=4}^6 z_i^4$ and

$$X = X_{(6,4)} = \{[z_1, \dots, z_6] \in \mathbb{P}^5(3, 2, 2, 1, 1, 1) \mid f_1(z_1, \dots, z_6) = f_2(z_1, \dots, z_6) = 0\},$$

then X is smooth, $e(X) = -156$, $b_3(X) = 160$ and $h^{1,2}(X) = 79$.

Table 2: Here we give some examples in codimension 2, where the first variable does not appear in the second defining polynomial

N^0	$X = X_{(d_1, d_2)} \subset \mathbb{P}^5(\mathbf{w})$	$e(X)$	$e(Y)$	$b_3(X)$	$b_3(Y)$	$h^{1,2}(Y)$	$h^{1,1}(Y)$
1	$X_{(4,3)} \subset \mathbb{P}^5(2, 1, 1, 1, 1, 1)$	-156	-156	160	160	79	1
2	$X_{(6,2)} \subset \mathbb{P}^5(3, 1, 1, 1, 1, 1)$	-256	-256	260	260	129	1
3	$X_{(6,4)} \subset \mathbb{P}^5(3, 2, 2, 1, 1, 1)$	-156	-156	160	160	79	1
4	$X_{(6,9)} \subset \mathbb{P}^5(2, 3, 3, 3, 3, 1)$	-96	-108	100	116	57	3
5	$X_{(8,4)} \subset \mathbb{P}^5(4, 2, 2, 2, 1, 1)$	-164	-168	168	174	86	2
6	$X_{(12,6)} \subset \mathbb{P}^5(4, 3, 3, 3, 3, 2)$	-76	-108	80	116	57	3

Remark 4.16. In string theory one class of c.i. in w.p.s., which is of particular interest, is that leading to toroidal crepant desingularizations Y whose Euler number has absolute value $|e(Y)| = 6$. Table 3 shows 39 hypersurfaces discovered by Klemm and Schimmrigk [74], which satisfy this property.

Table 3:

N^0	$X_d \subset \mathbb{P}^4(w_1, w_2, w_3, w_4, w_5)$	Polynomial	$e(Y)$	$h^{1,1}(Y)$	$h^{1,2}(Y)$
1	$X_{237} \subset \mathbb{P}^4(3, 8, 30, 79, 117)$	$-z_1^{79} + z_1^5 z_2^5 + z_1^3 z_3^3 + z_1^3 + z_1^2 z_2^2 + z_1^2 z_3^2 z_4^2 - z_1^2 z_5^2$	6	77	74
2	$X_{195} \subset \mathbb{P}^4(4, 5, 26, 65, 95)$	$z_1^{75} z_2^5 + z_1^{39} + z_1^3 z_2^4 + z_1^3 + z_1^2 z_2^2$	6	70	67
3	$X_{135} \subset \mathbb{P}^4(1, 21, 30, 38, 45)$	$-z_1^{35} + z_1^2 z_2^3 + z_1^2 z_3^3 + z_1^2 z_2^2 + z_1^2 z_3^2$	6	50	47
4	$X_{103} \subset \mathbb{P}^4(1, 16, 23, 29, 34)$	$z_1^{63} + z_1^2 z_2^3 + z_1^2 z_3^3 + z_1^2 z_2^2 + z_1^2 z_3^2$	6	50	47
5	$X_{135} \subset \mathbb{P}^4(5, 6, 14, 45, 65)$	$-z_1^{77} + z_1^5 z_2^4 + z_1^3 z_3^3 + z_1^3 + z_1^2 z_2^2$	6	45	42
6	$X_{83} \subset \mathbb{P}^4(2, 9, 12, 23, 37)$	$-z_1^{37} z_2^2 + z_1^3 z_2^4 + z_1^2 z_3^3 + z_1^2 z_2^2 + z_1 z_3^{30} + z_5 z_1^{23}$	6	40	37
7	$X_{123} \subset \mathbb{P}^4(4, 7, 13, 41, 58)$	$-z_1^{58} z_2^2 + z_1^3 z_2^5 + z_1^2 z_3^3 + z_1^2 + z_1^2 z_3^{21} + z_1 z_2^{13} + z_1^2 z_2^2 z_3^3$	6	40	37
8	$X_{105} \subset \mathbb{P}^4(4, 6, 15, 35, 45)$	$-z_1^{45} z_2^3 + z_1^5 z_3^3 + z_1^3 + z_1^2 + z_1^2 z_2^3 + z_5 z_1^{10}$	6	37	34
9	$X_{51} \subset \mathbb{P}^4(2, 6, 9, 17, 17)$	$-z_1^{17} z_2^3 + z_1^5 z_3^3 + z_1^3 + z_1^2 + z_1^2 z_2^3 + z_5 z_1^{10}$	6	37	34
10	$X_{81} \subset \mathbb{P}^4(2, 9, 19, 24, 27)$	$-z_1^{26} z_2^3 + z_1^2 + z_1^2 z_2^4 + z_1^2 z_3^3 + z_1^2 + z_3 z_1^{11}$	6	32	29
11	$X_{75} \subset \mathbb{P}^4(5, 8, 12, 15, 35)$	$z_1^5 + z_1^2 z_2^3 + z_1^2 z_4^3 + z_1^2 + z_1^2 z_1$	6	30	27
12	$X_{39} \subset \mathbb{P}^4(3, 4, 6, 13, 13)$	$-z_1^{13} + z_1^2 z_1 + z_1^2 z_1 + z_1^2 + z_1^2 + z_3 z_1^5 z_4$	6	29	26
13	$X_{49} \subset \mathbb{P}^4(4, 5, 10, 11, 19)$	$-z_1^{19} z_2^2 + z_1^2 z_2^3 + z_1^2 z_3^3 + z_1^2 z_4^3 + z_1^2 z_1^2 + z_5 z_1^9$	6	23	20
14	$X_{51} \subset \mathbb{P}^4(5, 6, 9, 10, 21)$	$-z_1^{21} z_2^2 + z_1^2 z_2^3 + z_1^2 z_3^3 + z_1^2 z_4^3 + z_1^2 z_1^2 + z_5 z_1^9$	6	23	20
15	$X_{75} \subset \mathbb{P}^4(10, 12, 13, 15, 25)$	$-z_1^{25} z_2^2 + z_1^2 z_2^4 + z_1^2 z_1 + z_1^2 + z_1^2 + z_2 z_1^2 z_3 + z_1^2 z_1^2$	6	20	17
16	$X_{51} \subset \mathbb{P}^4(5, 6, 9, 14, 17)$	$-z_1^{17} z_2^2 + z_1^2 z_2^3 + z_1^2 z_3^3 + z_1^2 z_4^3 + z_1^2 + z_1^2 z_1^2$	6	18	15
17	$X_{45} \subset \mathbb{P}^4(5, 8, 9, 11, 12)$	$-z_1^5 + z_1^2 z_1 + z_1^2 + z_1^2 z_2^3 + z_1^2 z_3^3$	6	16	13
18	$X_{177} \subset \mathbb{P}^4(3, 10, 18, 59, 87)$	$-z_1^{87} + z_1^2 z_2^3 + z_1^2 z_3^3 + z_1^2 + z_1^2 z_1 + z_1^2 z_2^2 z_1$	-6	57	60
19	$X_{147} \subset \mathbb{P}^4(2, 8, 29, 49, 59)$	$-z_1^{59} z_2^3 + z_1^5 z_3^3 + z_1^2 z_1 + z_1^2 + z_3 z_1^{14}$	-6	48	51
20	$X_{135} \subset \mathbb{P}^4(1, 18, 32, 39, 45)$	$-z_1^{35} + z_1^2 z_2^3 + z_1^2 z_3^3 + z_1^2 z_2^2 + z_1^2 z_3^2$	-6	47	50
21	$X_{97} \subset \mathbb{P}^4(1, 13, 23, 28, 32)$	$-z_1^{32} + z_1^2 z_2^3 + z_1^2 z_3^3 + z_1^2 z_2^2 + z_1^2 z_3^2$	-6	47	50
22	$X_{75} \subset \mathbb{P}^4(3, 5, 8, 24, 35)$	$-z_1^{35} + z_1^2 z_2^3 + z_1^2 z_3^3 + z_1^2 z_2^2 + z_1^2 z_3^2$	-6	40	43
23	$X_{77} \subset \mathbb{P}^4(2, 6, 15, 23, 31)$	$-z_1^{31} z_2^2 + z_1^2 z_2^4 + z_1^2 z_3^3 + z_1^2 z_2^3 + z_4 z_1^{27} + z_5 z_1^{23}$	-6	37	40
24	$X_{77} \subset \mathbb{P}^4(3, 6, 8, 23, 37)$	$-z_1^{37} z_2^2 + z_1^2 z_2^4 + z_1^2 z_3^3 + z_1^2 z_2^3 + z_1^2 z_1 + z_4 z_1^{18}$	-6	37	40
25	$X_{75} \subset \mathbb{P}^4(3, 9, 17, 22, 24)$	$-z_1^{25} + z_1^2 z_1 + z_1^2 z_2^3 + z_1^2 z_3^3 + z_1^2 z_1 + z_1^2 z_2^2$	-6	35	38
26	$X_{63} \subset \mathbb{P}^4(3, 4, 14, 21, 21)$	$-z_1^{21} + z_1^2 z_1 + z_1^2 z_2^3 + z_1^2 + z_1^2 z_1$	-6	32	35
27	$X_{81} \subset \mathbb{P}^4(3, 7, 18, 26, 27)$	$-z_1^{27} + z_1^2 z_2^3 + z_1^2 z_3^3 + z_1^2 z_1 + z_1^2 z_1$	-6	29	32
28	$X_{93} \subset \mathbb{P}^4(3, 8, 21, 30, 31)$	$-z_1^{31} + z_1^2 z_2^3 + z_1^2 z_3^3 + z_1^2 z_1 + z_1^2 z_1$	-6	29	32
29	$X_{75} \subset \mathbb{P}^4(3, 8, 13, 15, 36)$	$-z_1^{36} + z_1^2 z_1 + z_1^2 z_2^3 + z_1^2 + z_1^2 z_1 + z_5 z_1^{24}$	-6	29	32
30	$X_{63} \subset \mathbb{P}^4(3, 12, 15, 16, 17)$	$-z_1^{17} + z_1^2 z_1 + z_1^2 z_1 + z_1^2 z_2^3 + z_1^2 z_2^2 + z_3 z_1^2$	-6	29	32
31	$X_{55} \subset \mathbb{P}^4(3, 4, 12, 17, 19)$	$-z_1^{19} + z_1^2 z_1 + z_1^2 z_2^3 + z_1^2 + z_1^2 z_1 + z_5 z_1^{24}$	-6	26	29
32	$X_{45} \subset \mathbb{P}^4(3, 5, 8, 9, 20)$	$-z_1^{20} + z_1^2 + z_1^2 z_2^3 + z_1^2 + z_1^2 z_2^2 + z_3 z_1^2 z_4$	-6	23	26
33	$X_{93} \subset \mathbb{P}^4(5, 12, 13, 15, 20)$	$-z_1^{20} + z_1^2 z_1 + z_1^2 + z_1^2 z_1 + z_1^2 z_1 + z_1^2 z_2^3 + z_1^2 z_2^2 z_3$	-6	23	26
34	$X_{55} \subset \mathbb{P}^4(4, 4, 11, 17, 19)$	$-z_1^{19} z_2^2 + z_1^5 z_3^3 + z_1^2 z_1 + z_1^2 z_2^4 + z_1^2 z_2^2 + z_5 z_1^9$	-6	21	24
35	$X_{43} \subset \mathbb{P}^4(4, 4, 7, 13, 15)$	$-z_1^{15} z_2^2 + z_1^2 z_2^3 + z_1^2 z_3^3 + z_1^2 z_1 + z_1^2 z_2^4 + z_1^2 z_2^2 + z_3 z_1^2$	-6	20	23
36	$X_{45} \subset \mathbb{P}^4(3, 5, 8, 14, 15)$	$-z_1^{15} + z_1^2 + z_1^2 z_2^3 + z_1^2 z_1 + z_1^2 z_1$	-6	20	23
37	$X_{43} \subset \mathbb{P}^4(4, 5, 7, 8, 19)$	$-z_1^{19} z_2^2 + z_1^2 z_2^4 + z_1^2 z_3^3 + z_1^2 z_2^2 + z_1^2 z_1^2 + z_5 z_1^9 + z_1^2 z_1^2$	-6	20	23
38	$X_{25} \subset \mathbb{P}^4(4, 4, 5, 5, 7)$	$-z_1^{25} z_2^2 + z_1^2 z_2^3 + z_1^2 + z_1^2 + z_1^2 z_1 + z_1^2 z_2^4 + z_1^2 z_2^2$	-6	17	20
39	$X_{45} \subset \mathbb{P}^4(4, 7, 9, 10, 15)$	$-z_1^{15} z_2^2 + z_1^2 z_2^4 + z_1^2 + z_1^2 z_2^3 + z_1^2 + z_1^2 z_1^2$	-6	13	16

§ 5. Intersection forms and $[c_2]$ -linear forms

Let X be a well-formed, well-stratified q.s.c.i.

$X = X_{\mathbf{d}} = \{[z_1, \dots, z_m] \in \mathbb{P}^{m-1}(\mathbf{w}) \mid f_1(z_1, \dots, z_m) = \dots = f_k(z_1, \dots, z_m) = 0\}$ of dimension 3 with $\text{am}(X) = 0$, such that all curves C_j in $\text{SSt}^1(X)$ are *nondegenerate* in the sense of 2.32. (We shall keep here the notations, which were introduced at the beginning of § 4, in order to avoid lengthy repetitions.) By theorem 2.37., $\text{Pic}(X)$ is generated by the class of $\mathbf{L}_X = \mathcal{O}_X(\eta_X)$ (with η_X given by (2.24)), and (X, \mathbf{L}_X) is polarized. In this section, we shall study the forms $q_Y^{\mathbb{Q}}$ and $[c_2]_Y^{\mathbb{Q}}$, which are associated to the crepant toroidal desingularizations $\pi : Y \rightarrow X$ of X (cf. 1.3.), by using their evaluations at the members of the natural \mathbb{Q} -basis

$$B_Y := \{c_1(\mathbf{L}_Y), \{c_1(\mathcal{O}_Y(D)) \mid D \text{ exc. prime divisor} \in \mathcal{E}(X)\}\}$$

of $\text{Pic}_{\mathbb{Q}}(Y)$, where $\mathbf{L}_Y := \pi^* \mathbf{L}_X$.

Theorem 5.1. *Let $\pi : Y \rightarrow X$ be a crepant toroidal desingularization of X . Then:*

(i)

$$(5.1) \quad q_Y(\mathbf{L}_Y, \mathbf{L}_Y, \mathbf{L}_Y) = \mathbf{L}_Y^3 = \mathbf{L}_X^3$$

(ii)

(Y, \mathbf{L}_Y) is a quasi-polarized threefold

(iii)

$$(5.2) \quad h^i(Y, \mathbf{L}_Y) = \begin{cases} 0, & \text{for } i > 0 \\ h^0(X, \mathbf{L}_X), & \text{for } i = 0 \end{cases}$$

(iv)

$$(5.3) \quad [c_2]_Y(\mathbf{L}_Y) =: (c_2(Y) \cdot \mathbf{L}_Y) = (c_2(X) \cdot \mathbf{L}_X) = 12h^0(X, \mathbf{L}_X) - 2\mathbf{L}_X^3$$

(\mathbf{L}_X^3 and $h^0(X, \mathbf{L}_X) = h^0(X, \mathcal{O}_X(\eta_X))$ are given by (2.27) and (2.20).)

Proof. (i) Obvious by $\mathbf{L}_Y^3 = \deg(\pi) \mathbf{L}_X^3$ and $\deg(\pi) = 1$.

(ii) For an arbitrary curve \mathcal{C} on Y the projection formula gives: $(\mathbf{L}_Y \cdot \mathcal{C}) = (\mathbf{L}_X \cdot (\pi_* \mathcal{C})) \geq 0$ and therefore \mathbf{L}_Y inherits its numerical effectiveness from that of \mathbf{L}_X . \mathbf{L}_Y is also big, since $\mathbf{L}_Y^3 = \mathbf{L}_X^3 > 0$ by (2.27).

(iii) *1st case:* Let us first consider the case where Y is projective. Applying Kawamata-Viehweg vanishing theorem to \mathbf{L}_Y (cf. [76, 1.8.]) we get

$$h^i(Y, \omega_Y \otimes \mathbf{L}_Y) = h^i(Y, \mathbf{L}_Y) = 0, \quad \forall i, i > 0.$$

2nd case: Let now Y be arbitrary. We shall show that, even in this case, the above equality remains valid. Since X contains only quotient singularities, i.e. special *rational* singularities, we have

$$R^i \pi_* \mathcal{O}_Y \cong \begin{cases} \mathcal{O}_X, & \text{for } i = 0 \\ 0, & \text{for } i > 0 \end{cases}$$

which means that, by the projection formula for direct image sheaves (see [47, 12.2.3.2, p. 402]), one obtains:

$$\begin{aligned} R^i \pi_* \mathbf{L}_Y &= R^i \pi_* (\pi^* \mathbf{L}_X) \cong R^i (\pi_* (\mathcal{O}_Y \otimes \pi^* \mathbf{L}_X)) \\ &\cong (R^i \pi_* \mathcal{O}_Y) \otimes \mathbf{L}_X \cong \begin{cases} \mathbf{L}_X, & \text{for } i = 0 \\ 0, & \text{for } i > 0 \end{cases} \end{aligned}$$

On the other hand, the Leray spectral sequence $\{\mathbf{E}_r = \bigoplus_{i,j \geq 0} \mathbf{E}_r^{i,j}\}$, which is associated to $\pi : Y \rightarrow X$, converges to the term $\mathbf{E}_2 = \dots = \mathbf{E}_\infty$ with $\mathbf{E}_2^{i,j} = H^i(X, R^j \pi_* \mathbf{L}_Y)$ abutting to $H^{i+j}(Y, \mathbf{L}_Y)$. Thus, for all $i > 0$: $H^i(X, \mathbf{L}_X) \cong H^i(X, R^0 \pi_* \mathbf{L}_Y) \cong H^i(Y, \mathbf{L}_Y)$ (comp. [61], Exc. III 8.1., p. 252), and it is sufficient to prove that $H^i(X, \mathbf{L}_X) = 0, \forall i, i > 0$. This can be done by applying a suitable version of Grauert-Riemenschneider vanishing theorem (see [108, thm. 7.80. (f), pp. 157-158]) and taking into account the ampleness of \mathbf{L}_X and the triviality of ω_X .

Finally, from the connectedness of the fibers of π and the projection formula, we obtain $H^0(Y, \mathbf{L}_Y) \cong H^0(X, \mathbf{L}_X)$. q.e.d.

(iv) Since $\omega_Y \cong \mathcal{O}_Y$, Atiyah-Singer-Hirzebruch version of Riemann-Roch theorem (cf. [5, p. 20], [63, p. 155 and p. 187]) expresses the Euler-Poincaré characteristic

$$\chi(Y, \mathbf{L}_Y) = \sum_{i=0}^3 (-1)^i h^i(Y, \mathbf{L}_Y)$$

of the sheaf of holomorphic sections of \mathbf{L}_Y as follows:

$$(5.4) \quad \chi(Y, \mathbf{L}_Y) = \frac{\mathbf{L}_Y^3}{6} + \frac{(c_2(Y) \cdot \mathbf{L}_Y)}{12}$$

Hence, (5.4), combined with (5.1) and (5.2), implies

$$(c_2(Y) \cdot \mathbf{L}_Y) = 12\chi(Y, \mathbf{L}_Y) - 2\mathbf{L}_Y^3 = 12h^0(X, \mathbf{L}_X) - 2\mathbf{L}_X^3.$$

□

Lemma 5.2. *For a prime divisor D of a smooth, compact complex threefold Y with trivial canonical bundle we have:*

$$(5.5) \quad K_D^2 = D^3$$

$$(5.6) \quad (c_2(Y) \cdot \mathcal{O}_Y(D)) = 12\chi(D, \mathcal{O}_D) - 2D^3$$

Proof. (a) The adjunction formula and $\omega_Y \cong \mathcal{O}_Y$ give

$$\omega_D \cong \omega_Y \otimes \mathcal{O}_Y(D)|_D \cong \mathcal{O}_D(D) \cong \mathcal{N}_{D/Y} \Rightarrow K_D^2 = c_1^2(\omega_D)([D]) = c_1^2(\mathcal{N}_{D/Y})([D]) = D^3.$$

(b) If \mathcal{T}_D , resp. \mathcal{T}_Y is the tangent bundle of D , resp. of Y , then the normal bundle sequence $0 \rightarrow \mathcal{T}_D \rightarrow \mathcal{T}_{Y|D} \rightarrow \mathcal{N}_{D/Y} \rightarrow 0$, combined with Noether's formula and (5.5), implies

$$\begin{aligned} c(\mathcal{T}_{Y|D}) &= c(\mathcal{T}_D)c(\mathcal{N}_{D/Y}) = c(D)c(\omega_D) \Rightarrow \\ &(1 + (c_2(Y) \cdot \mathcal{O}_Y(D))) = (1 + c_1(D) + c_2(D))(1 - c_1(D)) \Rightarrow \\ &(c_2(Y) \cdot \mathcal{O}_Y(D)) = -K_D^2 + e(D) = 12\chi(D, \mathcal{O}_D) - 2D^3. \end{aligned}$$

□

We start the computation of the intersection numbers containing exceptional divisors from $\mathcal{E}(X)$ by considering firstly the case of a D sitting over a dissident point of X . (The computation will be done for a fixed Y , i.e. for a fixed choice of triangulations $\mathcal{S}_{P_1}, \dots, \mathcal{S}_{P_\lambda}, \mathcal{S}_{Q_1}, \dots, \mathcal{S}_{Q_\mu}$.)

Theorem 5.3. *The intersection numbers of an exceptional prime divisor D within $(\coprod_{i=1}^\lambda \mathcal{E}_{P_i}) \coprod (\coprod_{i=1}^\mu \mathcal{E}_{Q_i})$ with elements of $\mathcal{E}(X) \cup \{\mathbf{L}_Y\}$ are given by the following formulae:*

(i) *If $D = D_{n_{\mathfrak{p}_i}}^{(P_i)} \in \mathcal{E}_{P_i}$ (resp. $D = D_{n_{\mathfrak{q}_i}}^{(Q_i)} \in \mathcal{E}_{Q_i}$) with $n_{\mathfrak{p}_i}$ (resp. $n_{\mathfrak{q}_i}$) denoting a vertex of $\Phi_{G_{P_i}}$ (resp. of $\Phi_{G_{Q_i}}$), then:*

$$(5.7) \quad D^3 = 12 - \#(\text{Star}(\mathbb{R}_{\geq 0} n_{\mathfrak{p}_i})(2)) \quad (\text{resp. } D^3 = 12 - \#(\text{Star}(\mathbb{R}_{\geq 0} n_{\mathfrak{q}_i})(2)))$$

(5.8)

$$(c_2(Y) \cdot D) = 2\#(\text{Star}(\mathbb{R}_{\geq 0} n_{\mathfrak{p}_i})(2)) - 12 \quad (\text{resp. } (c_2(Y) \cdot D) = 2\#(\text{Star}(\mathbb{R}_{\geq 0} n_{\mathfrak{q}_i})(2)) - 12)$$

(ii) *For $D = D_{n_{\mathfrak{p}_i}}^{(P_i)} \in \mathcal{E}_{P_i}$ and $D' = D_{n_{\mathfrak{p}'_i}}^{(P_i)} \in \mathcal{E}_{P_i}$ with $1 \leq \mathfrak{p}_i, \mathfrak{p}'_i \leq a(P_i)$, $\mathfrak{p}_i \neq \mathfrak{p}'_i$, one computes $(D^2 \cdot D')$ and $(D \cdot D'^2)$ by means of a single vectorial \mathbb{Z} -linear dependence equation:*

$$(5.9) \quad (D^2 \cdot D')n_{\mathfrak{p}_i} + (D \cdot D'^2)n_{\mathfrak{p}'_i} + n(\mathfrak{p}_i, \mathfrak{p}'_i) + n(\mathfrak{p}'_i, \mathfrak{p}_i) = 0$$

where $n(\mathfrak{p}_i, \mathfrak{p}'_i)$, $n(\mathfrak{p}'_i, \mathfrak{p}_i)$ denote the unique vertices of $\Phi_{G_{P_i}} \coprod \{e_1, e_2, e_3\}$ for which $s(n_{\mathfrak{p}_i}, n_{\mathfrak{p}'_i}, n(\mathfrak{p}_i, \mathfrak{p}'_i))$ and $s(n_{\mathfrak{p}_i}, n_{\mathfrak{p}'_i}, n(\mathfrak{p}'_i, \mathfrak{p}_i))$ form two distinct 2-simplices of \mathcal{S}_{P_i} . (The intersection numbers $(D^2 \cdot D')$, $(D \cdot D'^2)$ can be computed by the same method, if D and D' correspond to vertices of $\Phi_{G_{Q_i}} \coprod \{e_1, e_2, e_3\}$ and Q_i is an individual point. We do not exclude the case in which both D and D' correspond to points of

$\partial s_0 \setminus \{e_1, e_2, e_3\}$, i.e. $(D, D') \in (\mathcal{E}_{C_j})^2$, where $Q_i = Q_{\nu_j}^{(j)} \in C_j$ for some j .)
(iii) The intersection numbers involving \mathbf{L}_Y vanish, i.e.

$$(5.10) \quad (\mathbf{L}_Y^2 \cdot D) = (\mathbf{L}_Y \cdot D^2) = 0$$

(iv) The intersection behaviour of three distinct divisors from \mathcal{E}_{P_i} or \mathcal{E}_{Q_i} is described by Prop. 3.6. (i). All the other possible triples lead to vanishing intersection numbers.

Proof. (i) The equality (5.7) is a reformulation of (3.3) applied to the c.q.s. $Z(N_{G_{P_i}}, \Sigma_0)$ (resp. $Z(N_{G_{Q_i}}, \Sigma_0)$). Since $\chi(D, \mathcal{O}_D) = 1$, (5.6) and (5.7) give (5.8). (ii) is an immediate consequence of prop. 3.6. (ii).
(iii) As \mathbf{L}_X is ample, $n\mathbf{L}_X$ will be very ample for some $n \gg 0$. If $D \in \mathcal{E}_{P_i}$ (resp. $D \in \mathcal{E}_{Q_i}$) and if we choose a general member \mathbf{M} of the linear system $|n\mathbf{L}_X|$, such that $P_i \notin \mathbf{M}$ (resp. $Q_i \notin \mathbf{M}$), then $\text{supp}(\pi^*\mathbf{M}) \cap \text{supp}(D) = \emptyset$, $\pi^*\mathbf{M}|_D \sim 0 \Rightarrow n^2(\mathbf{L}_Y^2 \cdot D) = ((\pi^*(n\mathbf{L}_X))^2 \cdot D) = ((\pi^*\mathbf{M})^2 \cdot D) = (\pi^*\mathbf{M}|_D)^2 = 0$ and $n(\mathbf{L}_Y \cdot D^2) = ((\pi^*(n\mathbf{L}_X) \cdot D^2) = ((\pi^*\mathbf{M}) \cdot D^2) = ((\pi^*\mathbf{M}|_D) \cdot (D|_D)) = 0$, i.e.

$$(\mathbf{L}_Y^2 \cdot D) = (\mathbf{L}_Y \cdot D^2) = 0.$$

(The existence of such an \mathbf{M} follows from the fact that $|n\mathbf{L}_X|$ separates points of X . See [61, ch. II, 7.8.2., p. 158].)

(iv) is obvious. □

Our next step will be the description of the intersection numbers which contain a divisor D located over a curve $C_j \in \text{SSt}^1(X)$, $1 \leq j \leq \kappa$. At first we shall need some technical lemmata.

Lemma 5.4. For each $1 \leq j \leq \kappa$, $1 \leq r_j \leq l_{C_j} - 1$, one contracts all

(-1) -curves of $D_{r_j}^{(C_j)}$ by a birational morphism $\varphi_{r_j}^{(j)} : D_{r_j}^{(C_j)} \rightarrow \bar{D}_{r_j}^{(C_j)}$, which factors into a composite of $\sum_{\nu_j=1}^{\xi_j} (b(n^{(\nu_j, r_j)}) - 1)$ blow-downs. Each $\bar{D}_{r_j}^{(C_j)}$ is endowed with the structure of a minimal (i.e. geometrically) ruled surface by $\bar{\pi}_{r_j}^{(j)} : \bar{D}_{r_j}^{(C_j)} \rightarrow C_j$, so that $\bar{\pi}_{r_j}^{(j)} \circ \varphi_{r_j}^{(j)} = \pi|_{D_{r_j}^{(C_j)}}$. Moreover,

$$(5.11) \quad K_{D_{r_j}^{(C_j)}}^2 = K_{\bar{D}_{r_j}^{(C_j)}}^2 - \sum_{\nu_j=1}^{\xi_j} (b(n^{(\nu_j, r_j)}) - 1)$$

Proof. We consider the pull-back

$$(\pi|_{D_{r_j}^{(C_j)}})^*([Q_{\nu_j}^{(j)}]) = \sum_{t^{(\nu_j, r_j)}=1}^{b(n^{(\nu_j, r_j)})} l_{t^{(\nu_j, r_j)}} \mathcal{C}(n^{(\nu_j, r_j)}, n_{t^{(\nu_j, r_j)}}^{(\nu_j, r_j)})$$

of the divisor $[Q_{\nu_j}^{(j)}]$, $1 \leq \nu_j \leq \xi_j$, under $\pi|_{D_{r_j}^{(C_j)}} : D_{r_j}^{(C_j)} \rightarrow C_j$ (cf. (4.17)), where $l_{t^{(\nu_j, r_j)}} \in \mathbb{N}$.

It should be first mentioned that $\gcd(\{l_{t^{(\nu_j, r_j)}} | 1 \leq t^{(\nu_j, r_j)} \leq b(n^{(\nu_j, r_j)})\}) = 1$. (Indeed, if the corresponding fiber were *multiple*, then by [5, Ch. III, Lemma 8.3., p. 91] one could conclude that \mathcal{O} (fiber) would be a torsion bundle and therefore that $H^1(\text{fiber}, \mathbb{Z}) \neq 0$. But this would be not true, because the fiber is simply connected.) Now since

$$-2 = (K_{D_{r_j}^{(C_j)}} \cdot (\text{generic fiber})) = (K_{D_{r_j}^{(C_j)}} \cdot ((\pi|_{D_{r_j}^{(C_j)}})^*([Q_{\nu_j}^{(j)}])))$$

there exists at least one index $\check{t}^{(\nu_j, r_j)} \in \{1, \dots, b(n^{(\nu_j, r_j)})\}$, such that $(K_{D_{r_j}^{(C_j)}} \cdot \mathcal{C}(n^{(\nu_j, r_j)}, n_{\check{t}^{(\nu_j, r_j)}}^{(\nu_j, r_j)})) < 0$. Making use of Zariski's fibration lemma [5, III. 8.2. (9), (10), p. 90], we deduce that $(\mathcal{C}(n^{(\nu_j, r_j)}, n_{\check{t}^{(\nu_j, r_j)}}^{(\nu_j, r_j)}))^2 < 0$. Thus $(\mathcal{C}(n^{(\nu_j, r_j)}, n_{\check{t}^{(\nu_j, r_j)}}^{(\nu_j, r_j)}))^2 = -1$ (see [5, III.2.2., p. 72]). We blow it smoothly down by Castelnuovo-Enriques contractibility criterion [5, III. 4.1., p. 78], play again the same game for the new fibration, and proceed succesively. After $\sum_{\nu_j=1}^{\xi_j} (b(n^{(\nu_j, r_j)}) - 1)$ steps we obtain $\bar{\pi}_{r_j}^{(j)} : \bar{D}_{r_j}^{(C_j)} \rightarrow C_j$. (5.11) is obvious. \square

Lemma 5.5. For a curve $C_j = X(I_j) \in \text{SSt}^1(X)$, $1 \leq j \leq k$, and an $n \in \mathbb{Z}$, we have:

(5.12)

$$\begin{aligned} \deg(\mathcal{O}_{C_j}(n)) = & \frac{1}{l_{C_j}} \left\{ h^0(C'_j, \mathcal{O}_{C'_j}(\theta(n; w_{t_1^j}, \dots, w_{t_{m-|I_j|}^j}))) - \right. \\ & - h^0(C'_j, \mathcal{O}_{C'_j}(\text{am}(C'_j) - \theta(n; w_{t_1^j}, \dots, w_{t_{m-|I_j|}^j}))) + \\ & \left. + h^0(C'_j, \mathcal{O}_{C'_j}(\text{am}(C'_j))) - 1 \right\} \end{aligned}$$

where C'_j is the q.s.c.i. coming from the normalization $w'_{t_1^j}, \dots, w'_{t_{m-|I_j|}^j}$ of the weights $w_{t_1^j}, \dots, w_{t_{m-|I_j|}^j}$ (cf. 2.29).

Proof. Apply (2.23) with $l_{C_j} = \gcd(w_{t_1^j}, \dots, w_{t_{m-|I_j|}^j})$. \square

Lemma 5.6. For the union \mathcal{E}_{C_j} of the exceptional prime divisors lying over a curve $C_j = X(I_j) \in \text{SSt}^1(X)$, $1 \leq j \leq k$ and indices $2 \leq r_j \leq l_{C_j} - 1$, we have:

(5.13)

$$\mathcal{O}_{D_{r_j-1}^{(C_j)} \cap D_{r_j}^{(C_j)}}(D_{r_j-1}^{(C_j)}) \cong \mathcal{O}_{C'_j}(\theta(r_j - \alpha_2^{(C_j)}; w_{t_1^j}, \dots, w_{t_{m-|I_j|}^j})) \quad \text{and}$$

(5.14)

$$\mathcal{O}_{D_{r_j-1}^{(C_j)} \cap D_{r_j}^{(C_j)}}(D_{r_j}^{(C_j)}) \cong \mathcal{O}_{C'_j}(\theta(1 - r_j + \alpha_2^{(C_j)}; w_{t_1^j}, \dots, w_{t_{m-|I_j|}^j}))$$

respectively. (The numbers $\alpha_1^{(C_j)}$ and $\alpha_2^{(C_j)}$ are determined by lemma 4.1.)

Proof. The application of resolutions (4.14) to the singularities occuring along $\mathcal{N}_{C_j/X}$ and (4.6) give rise to the following relations (cf. [103, thm. 1]):

$$\mathcal{O}_{D_{r_j-1}^{(C_j)} \cap D_{r_j}^{(C_j)}}(D_{r_j-1}^{(C_j)}) \cong \mathcal{O}_{C_j}(r_j \cdot \alpha_1^{(C_j)}) \otimes \mathcal{O}_{C_j}((r_j - l_{C_j}) \cdot \alpha_2^{(C_j)})$$

$$\mathcal{O}_{D_{r_j-1}^{(C_j)} \cap D_{r_j}^{(C_j)}}(D_{r_j}^{(C_j)}) \cong \mathcal{O}_{C_j}((1 - r_j) \cdot \alpha_1^{(C_j)}) \otimes \mathcal{O}_{C_j}((l_{C_j} - r_j + 1) \cdot \alpha_2^{(C_j)})$$

To get (5.13) and (5.14), we make use of $r_j \alpha_1^{(C_j)} + (r_j - l_{C_j}) \alpha_2^{(C_j)} = l_{C_j} (r_j - \alpha_2^{(C_j)})$, $(1 - r_j) \alpha_1^{(C_j)} + (l_{C_j} - r_j + 1) \alpha_2^{(C_j)} = l_{C_j} (1 - r_j + \alpha_2^{(C_j)})$ and of the isomorphisms of prop. 2.7. \square

Theorem 5.7. *The intersection numbers of an exceptional prime divisor within \mathcal{E}_{C_j} with elements of $\mathcal{E}_{C_j} \cup \{\mathbf{L}_Y\}$ (resp. of $\mathcal{E}(X) \cup \{\mathbf{L}_Y\}$) are given by the following formulae:*

(i) For $1 \leq r_j \leq l_{C_j} - 1$ and $g(C_j) = h^1(C_j, \mathcal{O}_{C_j})$ the genus of the curve C_j , we have:

(5.15)

$$(D_{r_j}^{(C_j)})^3 = 8(1 - g(C_j)) - \sum_{\nu_j=1}^{\xi_j} (b(n^{\nu_j, r_j}) - 1)$$

(5.16)

$$(c_2(Y) \cdot \mathcal{O}_Y(D_{r_j}^{(C_j)})) = -4(1 - g(C_j)) + 2 \left(\sum_{\nu_j=1}^{\xi_j} (b(n^{\nu_j, r_j}) - 1) \right)$$

(5.17)

$$(\mathbf{L}_Y^2 \cdot D_{r_j}^{(C_j)}) = 0$$

(5.18)

$$((D_{r_j}^{(C_j)})^2 \cdot \mathbf{L}_Y) = -2 \deg(\mathcal{O}_{C_j}(\eta_X))$$

(The latter is computable by (5.12)).

(ii) For group orders $|G_{C_j}| = l_{C_j} \geq 3$ and indices $2 \leq r_j \leq l_{C_j} - 1$, we get:

(5.19)

$$((D_{r_j-1}^{(C_j)})^2 \cdot D_{r_j}^{(C_j)}) = \deg(\mathcal{O}_{C_j'}(\theta(r_j - \alpha_2^{(C_j)}; w_{t_1^j}, \dots, w_{t_{m-|I_j|}^j})))$$

(5.20)

$$((D_{r_j}^{(C_j)})^2 \cdot D_{r_j-1}^{(C_j)}) = \deg(\mathcal{O}_{C_j'}(\theta(1 - r_j + \alpha_2^{(C_j)}; w_{t_1^j}, \dots, w_{t_{m-|I_j|}^j})))$$

(5.21)

$$(D_{r_j-1}^{(C_j)} \cdot D_{r_j}^{(C_j)} \cdot \mathbf{L}_Y) = \deg(\mathcal{O}_{C_j}(\eta_X))$$

(iii) The intersection numbers involving $D_{r_j}^{(C_j)}$ and other divisors of $(\prod_{i=1}^{\lambda} \mathcal{E}_{P_i}) \amalg (\prod_{i=1}^{\mu} \mathcal{E}_{Q_i})$ are already given by thm. 5.3. (ii). Moreover, if

$\kappa \geq 2$, $1 \leq j, j' \leq \kappa$, $j \neq j'$, $C_j \cap C_{j'} \neq \emptyset$, $C_j \cap C_{j'} = \{Q_1^{(j,j')}, \dots, Q_{\epsilon_{(j,j')}}^{(j,j')}\}$ denotes an enumeration of their common individual points and $D_{r_j}^{(C_j)}$ (resp. $D_{r_{j'}}^{(C_{j'})}$) is realized in the triangulation $\mathcal{S}_{Q_\rho^{(j,j')}}$ by $D_{n(r_j)}^{(\rho)}$ (resp. by $D_{n(r_{j'})}^{(\rho)}$), $\forall \rho$, $1 \leq \rho \leq \epsilon_{(j,j')}$, then

$$\begin{aligned} ((D_{r_j}^{(C_j)})^2 \cdot D_{r_{j'}}^{(C_{j'})}) &= \sum_{\rho=1}^{\epsilon_{(j,j')}} ((D_{n(r_j)}^{(\rho)})^2 \cdot D_{n(r_{j'})}^{(\rho)}) \\ (D_{r_j}^{(C_j)} \cdot (D_{r_{j'}}^{(C_{j'})})^2) &= \sum_{\rho=1}^{\epsilon_{(j,j')}} (D_{n(r_j)}^{(\rho)} \cdot (D_{n(r_{j'})}^{(\rho)})^2) \end{aligned}$$

(which are again known from thm. 5.3. (ii)).

(iv) All the other intersection numbers are zero.

Proof. We shall examine each case separately.

(i) (a) (5.15) follows from (5.5), (5.11), and from the fact, that the self-intersection number of the geometrically ruled surface $\bar{D}_{r_j}^{(C_j)}$, which was defined by lemma 5.4, is given by $K_{\bar{D}_{r_j}^{(C_j)}}^2 = 8(1 - g(C_j))$ (see [61, ch. V, cor. 2.11., p. 374]).

(b) Since $12\chi(D_{r_j}^{(C_j)}, \mathcal{O}_{D_{r_j}^{(C_j)}}) - 2(D_{r_j}^{(C_j)})^3 = 12(1 - g(C_j)) - 2K_{D_{r_j}^{(C_j)}}^2$, (5.6) combined with (5.11) gives (5.16).

(c) As \mathbf{L}_X is ample, $n\mathbf{L}_X$ will be very ample for some $n \gg 0$. If we consider two general members $\mathbf{M}_1, \mathbf{M}_2$ of linear system $|n\mathbf{L}_X|$, such that

$$\begin{aligned} \text{supp}(\mathbf{M}_1) \cap \text{supp}(\mathbf{M}_2) \cap C_j &= \emptyset, \quad \text{then} \\ \text{supp}(\pi^*\mathbf{M}_1) \cap \text{supp}(\pi^*\mathbf{M}_2) \cap \text{supp}(D_{r_j}^{(C_j)}) &= \emptyset \end{aligned}$$

for all $1 \leq r_j \leq l_{C_j} - 1$ and

$$\begin{aligned} n^2(\mathbf{L}_Y^2 \cdot D_{r_j}^{(C_j)}) &= ((\pi^*(n\mathbf{L}_X)) \cdot (\pi^*(n\mathbf{L}_X)) \cdot D_{r_j}^{(C_j)}) = \\ &= ((\pi^*\mathbf{M}_1) \cdot (\pi^*\mathbf{M}_2) \cdot D_{r_j}^{(C_j)}) = 0, \end{aligned}$$

$$\text{i.e. } (\mathbf{L}_Y^2 \cdot D_{r_j}^{(C_j)}) = 0.$$

[The existence of such divisors \mathbf{M}_1 and \mathbf{M}_2 on X can be proven as follows: Using Mumford's version of the "moving lemma" (cf. [46, § 11.4], which is valid for V -varieties (if rational coefficients are allowed, comp. [46, 11.4.7.]), we can assume that \mathbf{M}_1 meets C_j properly, i.e. that $\text{supp}(\mathbf{M}_1) \cap C_j$ consists of at most finitely many points. By support moving, we may further choose \mathbf{M}_2 in such a way, that $\text{supp}(\mathbf{M}_2)$ avoids meeting these points. (Remark: Note that the vanishing of the

intersection numbers (5.10) and (5.17) imply the non-ampleness of \mathbf{L}_Y , according to Nakai-Moishezon criterion, cf. [61, App. A, thm. 5.1., p. 434].)

(d) $((D_{r_j}^{(C_j)})^2 \cdot \mathbf{L}_Y)$ cannot, in general, vanish, because it contains many informations coming from the underlying curve C_j , as we get:

$$(5.22) \quad \begin{aligned} ((D_{r_j}^{(C_j)})^2 \cdot \mathbf{L}_Y) &= (\omega_{D_{r_j}^{(C_j)}} \cdot \mathbf{L}_Y|_{D_{r_j}^{(C_j)}}) = (\mathcal{O}_{D_{r_j}^{(C_j)}}(K_{D_{r_j}^{(C_j)}})(\pi|_{D_{r_j}^{(C_j)}})^*(\mathbf{L}_X|_{C_j})) = \\ &= (\mathcal{O}_{D_{r_j}^{(C_j)}}(K_{D_{r_j}^{(C_j)}}) \cdot (\pi|_{D_{r_j}^{(C_j)}})^*(\mathcal{O}_{C_j}(G))) = (K_{D_{r_j}^{(C_j)}} \cdot ((\pi|_{D_{r_j}^{(C_j)}})^*(G))), \end{aligned}$$

where $G = \sum_{i=1}^{\tau} \mathfrak{d}_i G_i$, $\mathfrak{d}_i \in \mathbb{Z}$, $1 \leq i \leq \tau$, denotes the divisor of C_j which is associated to the line bundle $\mathbf{L}_X|_{C_j} = \mathcal{O}_{C_j}(\eta_X)$. Suppose that $b(n^{(\nu_j, r_j)}) > 1$ for all $1 \leq \nu_j \leq \xi_j$.

(The case in which $b(n^{(\nu_j, r_j)}) = 1$, for some ν_j 's, can be treated similarly.) If we assume, without loss of generality, that the set of curves, which are contracted by $\varphi_{r_j}^{(j)}$, is $\{\mathcal{C}(n^{(\nu_j, r_j)}, n_{t^{(\nu_j, r_j)}}^{(\nu_j, r_j)}) | 2 \leq t^{(\nu_j, r_j)} \leq b(n^{(\nu_j, r_j)})\}$, then we can describe the relationship between the canonical divisors of $D_{r_j}^{(C_j)}$ and $\bar{D}_{r_j}^{(C_j)}$ as follows:

$$(5.23) \quad K_{D_{r_j}^{(C_j)}} \sim (\varphi_{r_j}^{(j)})^*(K_{\bar{D}_{r_j}^{(C_j)}}) + \sum_{\nu_j=1}^{\xi_j} \left(\sum_{t^{(\nu_j, r_j)}=2}^{b(n^{(\nu_j, r_j)})} \mathcal{C}(n^{(\nu_j, r_j)}, n_{t^{(\nu_j, r_j)}}^{(\nu_j, r_j)}) \right)$$

Note that

$$(5.24) \quad K_{\bar{D}_{r_j}^{(C_j)}} \sim (-2) \text{ (a section of } \bar{\pi}_{r_j}^{(j)}) + (\bar{\pi}_{r_j}^{(j)})^*(K_{C_j} + E_{r_j}^{(j)})|_{F_{r_j}^{(j)}}$$

where $E_{r_j}^{(j)}$ is a divisor of C_j with $\deg(E_{r_j}^{(j)}) = C_j^2$ and $F_{r_j}^{(j)}$ a fiber of

$$\bar{\pi}_{r_j}^{(j)} : \bar{D}_{r_j}^{(C_j)} \rightarrow C_j \quad (\text{cf. [61, ch. V, lemma 2.10., p. 373]}).$$

$\mathbf{L}_X|_{C_j}$ is ample. So there is again an $n \gg 0$ for which $n(\mathbf{L}_X|_{C_j})$ is very ample. If \mathbf{N}_j is a general member of $|n(\mathbf{L}_X|_{C_j})|$, such that

$$\begin{aligned} \text{supp}(\mathbf{N}_j) \cap \{Q_1^{(j)}, \dots, Q_{\xi_j}^{(j)}\} &= \emptyset, \quad \text{then} \\ \text{supp}((\pi|_{D_{r_j}^{(C_j)}})^*(\mathbf{N}_j)) \cap \left(\bigcup_{\nu_j=1}^{\xi_j} \bigcup_{t^{(\nu_j, r_j)}=2}^{b(n^{(\nu_j, r_j)})} \mathcal{C}(n^{(\nu_j, r_j)}, n_{t^{(\nu_j, r_j)}}^{(\nu_j, r_j)}) \right) &= \emptyset \end{aligned}$$

and therefore (5.23) gives:

$$(5.25) \quad (K_{D_{r_j}^{(C_j)}} \cdot ((\pi|_{D_{r_j}^{(C_j)}})^*(G))) = \left((\varphi_{r_j}^{(j)})^*(K_{\bar{D}_{r_j}^{(C_j)}}) \right) \cdot \left((\pi|_{D_{r_j}^{(C_j)}})^*(G) \right)$$

Combining now (5.22), (5.24) and (5.25) we get:

$$\begin{aligned}
& ((D_{r_j}^{(C_j)})^2 \cdot \mathbf{L}_Y) = \\
& ((\varphi_{r_j}^{(j)})^*(-2C_j + (\bar{\pi}_{r_j}^{(j)})^*(K_{C_j} + E_{r_j}^{(j)})|_{F_{r_j}^{(j)}})) \cdot (\varphi_{r_j}^{(j)})^* \left(\sum_{i=1}^{\tau} \mathfrak{d}_i(\bar{\pi}_{r_j}^{(j)})^*(G_i) \right)) = \\
& = -2 \left(\sum_{i=1}^{\tau} \mathfrak{d}_i(C_j \cdot (\bar{\pi}_{r_j}^{(j)})^*(G_i)) \right) + \sum_{i=1}^{\tau} \mathfrak{d}_i(((\bar{\pi}_{r_j}^{(j)})^*(K_{C_j} + E_{r_j}^{(j)})|_{F_{r_j}^{(j)}}) \cdot (\bar{\pi}_{r_j}^{(j)})^*(G_i)) = \\
& = -2 \left(\sum_{i=1}^{\tau} \mathfrak{d}_i \right) = -2\deg(G) = -2\deg(\mathbf{L}_X|_{C_j}) = -2\deg(\mathcal{O}_{C_j}(\eta_X)),
\end{aligned}$$

because $\deg(\varphi_{r_j}^{(j)}) = 1$, $(\bar{\pi}_{r_j}^{(j)})^*(G_i) \sim F_{r_j}^{(j)}$, $\forall i, 1 \leq i \leq \tau$, $(F_{r_j}^{(j)})^2 = 0$ and $(C_j \cdot F_{r_j}^{(j)}) = 1$.

(ii) (5.19) and (5.20) follow directly from (5.13) and (5.14). On the other hand,

$$(D_{r_j-1}^{(C_j)} \cdot D_{r_j}^{(C_j)} \cdot \mathbf{L}_Y) = ((D_{r_j-1}^{(C_j)}|_{D_{r_j-1}^{(C_j)} \cap D_{r_j}^{(C_j)}}) \cdot \mathbf{L}_Y|_{D_{r_j}^{(C_j)}}) = \deg(\mathbf{L}_X|_{C_j}) = \deg(\mathcal{O}_{C_j}(\eta_X)).$$

(iii) and (iv) are obvious. □

Recapitulating, one can verify that the formulae of theorems 5.1., 5.3. and 5.7., which have been proved above, cover all $\binom{h^{1,1}(Y) + 2}{3}$ triples that can be formed from elements of \mathcal{B}_Y . We shall now mention two additional arithmetical relations which are fulfilled by the intersection numbers. (See Oguiso and Peternell [95, (1.1.)].)

Proposition 5.8. *Let $\pi : Y \rightarrow X$ be a toroidal crepant desingularization of X and $D \in \mathcal{E}(X)$. Then*

$$(5.26) \quad (D \cdot \mathbf{L}_Y^2)^2 \geq (D^2 \cdot \mathbf{L}_Y)(\mathbf{L}_Y^3)$$

$$(5.27) \quad (D \cdot \mathbf{L}_Y^2) \equiv (D^2 \cdot \mathbf{L}_Y) \pmod{2}$$

Proof. ([95]) Let m be a large odd number and S a general element of $|m\mathbf{L}_Y|$. By the base-point-freeness theorem, we can choose m in such a way, that S is a smooth irreducible surface. Hodge-index theorem implies:

$$(D|_S \cdot (\mathbf{L}_Y|_S))^2 \geq (D|_S)^2 (\mathbf{L}_Y|_S)^2 \Rightarrow (D \cdot \mathbf{L}_Y^2)^2 \geq (D^2 \cdot \mathbf{L}_Y)(\mathbf{L}_Y^3).$$

On the other hand, by Riemann-Roch theorem for smooth surfaces and by adjunction formula $K_S = S|_S$, we get:

$$\chi(S, \mathcal{O}_S(D|_S)) - \chi(S, \mathcal{O}_{D|_S}) = \frac{1}{2}((D|_S)^2 - (D|_S) \cdot K_S) = \frac{1}{2}(m(D^2 \cdot \mathbf{L}_Y) - m^2(D \cdot \mathbf{L}_Y^2)),$$

which means that $(D \cdot \mathbf{L}_Y^2) \equiv (D^2 \cdot \mathbf{L}_Y) \pmod{2}$, because $m \equiv 1 \pmod{2}$. \square

Remark 5.9. Basically, Oguiso and Peternell showed that the above proof remains valid, even if (X, \mathbf{L}_X) is an arbitrary polarized CY model, (Y, \mathbf{L}_Y) a quasipolarized CY model and $\pi : Y \rightarrow X$ a partial crepant desingularization of X . Note that the congruence $(D_1^2 \cdot D_2) \equiv (D_1 \cdot D_2^2) \pmod{2}$ holds true for any divisor D_1 and D_2 of a *smooth* simply connected 3-dimensional variety Y with trivial canonical bundle and torsion-free cohomology groups, and that it was already known by C.T.C. Wall [122, thm. 5, p. 361]. Furthermore, for such a Y we have: $[c_2]_Y(D) \equiv -2D^3 \pmod{12}$, for all divisors D , because the first Pontrjagin class equals $-2c_2$.

Up to now we have calculated the evaluations of $q_Y^{\mathbb{Q}}$ - and $[c_2]_Y^{\mathbb{Q}}$ - forms with respect to fixed triangulations $\mathcal{S}_{P_1}, \dots, \mathcal{S}_{P_\lambda}, \mathcal{S}_{Q_1}, \dots, \mathcal{S}_{Q_\mu}$. As we know from prop. 4.3., two distinct toroidal crepant desingularizations of X differ from each other by finitely many (simple) flops. Hence, up to an “arrangement algorithm” for the 1-simplices within our triangle subdivisions, the alteration of $q_Y^{\mathbb{Q}}$ and $[c_2]_Y^{\mathbb{Q}}$ due to the choice of other triangulations will be clear if we describe just the “single-flop” case.

Theorem 5.10. *Let $X = X_{\mathbf{d}} \subset \mathbb{P}^{m-1}(\mathbf{w})$ be a well-formed, well-stratified q.s.c.i. with $\text{am}(X) = 0$ and $\dim_{\mathbb{C}}(X) = 3$, and let $\pi_1 : Y_1 \rightarrow X$ be a toroidal crepant desingularization of X with $\text{SSt}^0(X) \neq \emptyset$. Suppose that $P_i \in \text{SSt}^0(X)$ is an isolated point of $\text{Sing}(X)$, for which $\sharp(\Phi_{G_{P_i}}) \geq 4$, and that the corresponding triangulation \mathcal{S}_{P_i} satisfies the following properties:*

- (i) *There exist vertices n_1, n_2, n_3, n_4 from $s_0 \cap N_{G_{P_i}}$, such that $s(n_1, n_2, n_3)$ and $s(n_1, n_2, n_4)$ are two distinct 2-simplices of \mathcal{S}_{P_i} , and*
- (ii) *$s(n_1, n_2, n_3, n_4)$ forms a convex quadrilateral of \mathcal{S}_{P_i} .*

If $\pi_2 : Y_2 \rightarrow X$ is the toroidal crepant desingularization of X with Y_2 obtained by Y_1 after flopping the curve $\mathcal{C}(n_1, n_2)$ (i.e. after applying the elementary transformation $\Sigma'_0(\tilde{\mathcal{S}}_{P_i})$ of $\Sigma'_0(\mathcal{S}_{P_i})$ w.r.t. $\sigma(s(n_1, n_2, n_3))$, $\sigma(s(n_1, n_2, n_4))$ and $\sigma(s(n_1, n_2))$) and if $D_{n_j}^{(\mathcal{S}_{P_i})}$, resp. $D_{n_j}^{(\tilde{\mathcal{S}}_{P_i})}$, denote the exceptional prime divisors associated to n_j in \mathcal{S}_{P_i} , resp. in $\tilde{\mathcal{S}}_{P_i}$, $\forall j, 1 \leq j \leq 4$, then their intersection numbers and their images under the $[c_2]$ -form are related as follows:

$$(5.28) \quad \begin{aligned} ((D_{n_j}^{(\mathcal{S}_{P_i})})^2 \cdot D_{n_{j'}}^{(\mathcal{S}_{P_i})}) - ((D_{n_j}^{(\tilde{\mathcal{S}}_{P_i})})^2 \cdot D_{n_{j'}}^{(\tilde{\mathcal{S}}_{P_i})}) &= (D_{n_j}^{(\mathcal{S}_{P_i})} \cdot (D_{n_{j'}}^{(\mathcal{S}_{P_i})})^2) - (D_{n_j}^{(\tilde{\mathcal{S}}_{P_i})} \cdot (D_{n_{j'}}^{(\tilde{\mathcal{S}}_{P_i})})^2) \\ &= \begin{cases} -1, & \text{for } (j, j') \in \{(1, 2), (2, 1)\} \\ 1, & \text{for } (j, j') \in \{(3, 4), (4, 3)\} \\ 0, & \text{otherwise} \end{cases} \end{aligned}$$

$\forall j, j', 1 \leq j, j' \leq 4$. In particular, for all $j \in \{1, 2, 3, 4\}$, for which $n_j \in \text{int}(s_0) \cap N_{G_{P_i}}$, we have:

$$(5.29) \quad (D_{n_j}^{(\mathcal{S}_{P_i})})^3 - (D_{n_j}^{(\tilde{\mathcal{S}}_{P_i})})^3 = \begin{cases} -1, & \text{if } j \in \{1, 2\} \\ 1, & \text{if } j \in \{3, 4\} \end{cases}$$

Moreover,

$$(5.30) \quad \begin{aligned} [c_2]_{Y_1}(D_{n_j}^{(\mathcal{S}_{P_i})}) - [c_2]_{Y_2}(D_{n_j}^{(\tilde{\mathcal{S}}_{P_i})}) &= -2(D_{n_j}^{(\mathcal{S}_{P_i})} \cdot \mathcal{C}(n_1, n_2)) = \\ &= 2(D_{n_j}^{(\tilde{\mathcal{S}}_{P_i})} \cdot \mathcal{C}(n_3, n_4)) = \begin{cases} 2, & \text{if } j \in \{1, 2\} \\ -2, & \text{if } j \in \{3, 4\} \end{cases} \end{aligned}$$

(Note that if we assume that $\text{INP}(X) \neq \emptyset$, Q_i is an individual point of $\text{Sing}(X)$, and Y_2 comes from Y_1 just by an elementary transformation $\Sigma'_0(\tilde{\mathcal{S}}_{Q_i})$ of $\Sigma'_0(\mathcal{S}_{Q_i})$ as above, then the formula (5.28) remains true whenever one replaces P_i by Q_i . Analogously (5.29) and (5.30) remain valid for all $j \in \{1, 2, 3, 4\}$, for which $n_j \in (s_0 \cap N_{G_{Q_i}}) \setminus \{e_1, e_2, e_3\}$.)

Proof. (5.28) follows from $n_1 + n_2 = n_3 + n_4$ and (3.2) or (5.9). Similarly, one gets (5.29) and (5.30) by using the formulae (5.7) and (5.8) (resp. (5.15) and (5.16)). \square

Remark 5.11. Formulae (5.28), (5.29) and (5.30) can be viewed not only as realizations of our computational algorithm for this concrete construction, but also as special cases of more general formulae holding true for any flop along a rational $(-1, -1)$ -curve of an arbitrary smooth complex threefold. For such an approach, see Friedman [42, 7.4. and 7.5., p. 123].

Remark 5.12. It should be noted that, after having given the description of the strata of $\text{Sing}(X)$, the main part of the desingularization method which was developed in § 4, does not depend intrinsically on the embedding of X 's in $\mathbb{P}^{m-1}(\mathbf{w})$, and can be actually applied to any CY model being a V -variety with cyclic (or, more general, abelian) quotient singularities and globally known singular locus [24]. If, however, one considers the special case, in which our Y 's can be represented as strict transforms of appropriate crepant desingularizations of $\mathbb{P}^{m-1}(\mathbf{w})$, then it is possible to determine not only the evaluations of $[c_2]_Y^{\mathbb{Q}}$ at a member of \mathcal{B}_Y , but also the second rational Chern class $c_2^{\mathbb{Q}}(Y) \in H^4(Y, \mathbb{Q})$ itself.

Let us explain this more closely. We can conceive the space $\mathbb{P}^{m-1}(\mathbf{w})$ itself as a toric complete variety $\mathbb{P}^{m-1}(\mathbf{w}) = Z(N(\mathbf{w}), \Sigma(\mathbf{w}))$ (in the notation of § 3) by setting $N(\mathbf{w}) := N_0/\mathbb{Z}w_0$, $N_0 = \sum_{i=1}^m \mathbb{Z}e_i$, $w_0 := \sum_{i=1}^m w_i e_i$ ($e_i := (0, \dots, 1, \dots, 0)$ with 1 in the i -th place), $\Sigma(\mathbf{w}) := \{\{\sigma_i \mid 1 \leq i \leq m\}$, together with their faces $\}$, where

$$\sigma_i := \begin{cases} \mathbb{R}_{\geq 0}n(w_2) + \dots + \mathbb{R}_{\geq 0}n(w_m), & i = 1 \\ \mathbb{R}_{\geq 0}n(w_1) + \dots + \mathbb{R}_{\geq 0}n(w_{i-1}) + \mathbb{R}_{\geq 0}n(w_{i+1}) + \dots + \mathbb{R}_{\geq 0}n(w_m), & 2 \leq i \leq m-1 \\ \mathbb{R}_{\geq 0}n(w_1) + \dots + \mathbb{R}_{\geq 0}n(w_{m-1}), & i = m \end{cases}$$

and $n(w_i) := e_i + \mathbb{Z}w_0$, $\forall i, 1 \leq i \leq m$. If we assume that $\mathbb{P}^{m-1}(\mathbf{w})$ is *Gorenstein*, i.e. $\text{lcm}(w_1, \dots, w_m) \mid \sum_{i=1}^m w_i$ (cf. [10, cor. 6.B.10 (a)]), then, following Batyrev [7], we can always construct a projective maximal crepant $T_{N(\mathbf{w})}$ -equivariant resolution

$$\hat{\pi} : \hat{\mathbb{P}}^{m-1}(\mathbf{w}) := Z(N(\mathbf{w}), \hat{\Sigma}(\mathbf{w})) \rightarrow \mathbb{P}^{m-1}(\mathbf{w})$$

of singularities of $\mathbb{P}^{m-1}(\mathbf{w})$ (by means of suitable projective subdivisions of the SCRPC's of $\Sigma(\mathbf{w})$ gluing together to give $\hat{\Sigma}(\mathbf{w})$) such that

$$\hat{\pi}|_Y = \pi : Y \rightarrow X,$$

i.e. such that our Y appears as strict transform of X under $\hat{\pi}$. If we assume that the zero-locus of each of the defining polynomials

$$f_i \in H^0(\mathbb{P}^{m-1}(\mathbf{w}), \mathcal{O}_{\mathbb{P}^{m-1}(\mathbf{w})}(d_i)), 1 \leq i \leq k$$

is an ample divisor, then Y can be represented as the intersection of k divisors $D_1 = (\varphi_1 = 0), \dots, D_k = (\varphi_k = 0)$, where

$$\varphi_i \in H^0(\hat{\mathbb{P}}^{m-1}(\mathbf{w}), \pi^* \mathcal{O}_{\mathbb{P}^{m-1}(\mathbf{w})}(d_i)), \forall i, 1 \leq i \leq k$$

Denoting the inclusion map of Y in $\hat{\mathbb{P}}^{m-1}(\mathbf{w})$ by $j : Y \hookrightarrow \hat{\mathbb{P}}^{m-1}(\mathbf{w})$, we have:

Proposition 5.13. *Let $\hat{\Sigma}(\mathbf{w})(1) = \{\hat{\rho}_1, \dots, \hat{\rho}_\nu\}$, $\nu \geq \sharp(\Sigma(\mathbf{w})(1)) = m$, be the set of 1-dimensional SCRPC's of the fan $\hat{\Sigma}(\mathbf{w})$. Then:*

$$(5.31) \quad c_2^{\mathcal{Q}}(Y) = \sum_{1 \leq i_1 < i_2 \leq \nu} \left\{ c_1^{\mathcal{Q}}(\mathcal{O}_Y(V(\hat{\rho}_{i_1}))) \smile c_1^{\mathcal{Q}}(\mathcal{O}_Y(V(\hat{\rho}_{i_2}))) \right\} -$$

$$- \begin{cases} 0, & \text{if } m = 5 \\ \sum_{1 \leq i_1 < i_2 \leq k} \left\{ c_1^{\mathcal{Q}}(j^*(\mathcal{O}_{\hat{\mathbb{P}}^{m-1}(\mathbf{w})}(D_{i_1}))) \smile c_1^{\mathcal{Q}}(j^*(\mathcal{O}_{\hat{\mathbb{P}}^{m-1}(\mathbf{w})}(D_{i_2}))) \right\}, & \text{if } m \geq 6. \end{cases}$$

Proof. By the normal bundle sequence

$$(5.32) \quad 0 \rightarrow \mathcal{T}_Y \rightarrow \mathcal{T}_{\hat{\mathbb{P}}^{m-1}(\mathbf{w})}|_Y \rightarrow \mathcal{N}_{Y/\hat{\mathbb{P}}^{m-1}(\mathbf{w})} \rightarrow 0$$

we get

$$(5.33) \quad c^{\mathcal{Q}}(Y) \cdot c^{\mathcal{Q}}(\mathcal{N}_{Y/\hat{\mathbb{P}}^{m-1}(\mathbf{w})}) = c^{\mathcal{Q}}(\mathcal{T}_{\hat{\mathbb{P}}^{m-1}(\mathbf{w})}|_Y).$$

Since

$$(5.34) \quad c^{\mathcal{Q}}(\mathcal{N}_{Y/\hat{\mathbb{P}}^{m-1}(\mathbf{w})}) = \prod_{i=1}^k (1 + c_1^{\mathcal{Q}}(j^* \mathcal{O}_{\hat{\mathbb{P}}^{m-1}(\mathbf{w})}(D_i)))$$

and correspondingly

$$(5.35) \quad c^{\mathcal{Q}}(\hat{\mathbb{P}}^{m-1}(\mathbf{w})) = \prod_{i=1}^{\nu} (1 + c_1^{\mathcal{Q}}(\mathcal{O}_{\hat{\mathbb{P}}^{m-1}(\mathbf{w})}(V(\hat{\rho}_i))),$$

(see [46, 3.2.12., p. 59] and [71, p.131]), the relation (5.33), combined with $c_1^{\mathcal{Q}}(Y) = 0$, $c^{\mathcal{Q}}(\mathcal{T}_{\hat{\mathbb{P}}^{m-1}(\mathbf{w})}|_Y) = c^{\mathcal{Q}}(j^*(\mathcal{T}_{\hat{\mathbb{P}}^{m-1}(\mathbf{w})})) = j^*(c^{\mathcal{Q}}(\mathcal{T}_{\hat{\mathbb{P}}^{m-1}(\mathbf{w})}))$, (5.34), (5.35) and the usual multiplication rule, gives (5.31). \square

§ 6. Topology change after flopping

As it follows from rem. 4.5.(ii) and thm. 5.10., two distinct toroidal crepant desingularizations Y_1, Y_2 of an X do not respect, in general, the topological “triple couplings” and the $[c_2]$ -forms, although they have identical Hodge diamonds. This “typical phenomenon” leads to the conjecture that most of the pairs (Y_1, Y_2) will be equipped with different topologies. (A geometrical method for the determination of the number of all possible projective toroidal crepant desingularizations is described in [24].) We shall illustrate here just an indicative example and explain how the testing bilinear forms (cf. 1.4.) can be used in order to distinguish diffeomorphism (resp. homotopy) types according to lemma 1.5.

Let $X = X_{36} = \{[z_1, z_2, z_3, z_4, z_5] \in \mathbb{P}^4(1, 2, 3, 12, 18) \mid z_1^{36} + z_2^{18} + z_3^{12} + z_4^3 + z_5^2 = 0\}$ be the Fermat hypersurface of degree 36 (with delta genus $\Delta(X, \mathbf{L}_X) = 2$). It is $\text{Pic}(X) = \langle [\mathbf{L}_X] \rangle$, $\mathbf{L}_X = \mathcal{O}_X(\eta_X)$, with $\eta_X = \text{lcm}(1, 2, 3, 6) = 6$, $\mathbf{L}_X^3 = 6$, $h^{1,1}(X) = b_2(X) = 1$, $h^{1,2}(X) = 182$ (by (2.17)) and $e(X) = 2(1 - h^{1,2}(X)) = -362$. The singular locus of X can be written as the union $\text{Sing}(X) = C_1 \cup C_2$ of two curves $C_1 := X_{\{1,3\}}$ and $C_2 := X_{\{1,2\}}$ having the individual point $Q := [0, 0, 0, -1, 1]$ as their intersection locus $C_1 \cap C_2 = X_{\{1,2,3\}} = \{Q\}$. By prop. 2.30., we have the isomorphisms:

$$C_1 = (X_{36} \subset \mathbb{P}^2(2, 12, 18)) \cong (X_{18} \subset \mathbb{P}^2(1, 6, 9)) \cong (X_6 \subset \mathbb{P}^2(1, 2, 3)) = C'_1,$$

because, in the notation of 2.2., $(\overline{2}, \overline{12}, \overline{18}) = (1, 6, 9)$, $\rho_1(2, 12, 18) = \text{gcd}(6, 9) = 3$, $\rho_2(2, 12, 18) = \rho_3(2, 12, 18) = 1$ and therefore $(2', 12', 18') = (1, 2, 3)$. Since $l_{C_1} = 2$ and $\text{am}(C'_1) = 0$, the genus $g(C_1) = g(C'_1)$ of C_1 equals $h^0(C_1, \mathcal{O}_{C_1}) = 1$ and by (5.12): $\text{deg}(\mathcal{O}_{C_1}(6)) = \frac{1}{2}h^0(C'_1, \mathcal{O}_{C'_1}(\theta(6; 2, 12, 18)))$. Using the notation of 2.6., we get: $\gamma_1(6; 2, 12, 18) = \gamma_2(6; 2, 12, 18) = \gamma_3(6; 2, 12, 18) = 0$, $\varepsilon_1(6; 2, 12, 18) = 2$, $\varepsilon_2(6; 2, 12, 18) = 6$, $\varepsilon_3(6; 2, 12, 18) = 6$. Thus, $\theta(6; 2, 12, 18) = \frac{1}{3}(6 - 0) = 2$ and $\text{deg}(\mathcal{O}_{C_1}(6)) = \frac{1}{2}(pt(2; 1, 2, 3) - pt(-4; 1, 2, 3)) = \frac{1}{2}(2 - 0) = 1$. Similarly we have:

$$C_2 = (X_{36} \subset \mathbb{P}^2(3, 12, 18)) \cong (X_{12} \subset \mathbb{P}^2(1, 4, 6)) \cong (X_6 \subset \mathbb{P}^2(1, 2, 3)) = C'_2 \cong C'_1,$$

$$(\overline{3}, \overline{12}, \overline{18}) = (1, 4, 6), \rho_1(3, 12, 18) = 2, \rho_2(3, 12, 18) = \rho_3(3, 12, 18) = 1,$$

$$(3', 12', 18') = (1, 2, 3), l_{C_2} = 3, g(C_2) = g(C'_2) = 1, \gamma_1(6; 3, 12, 18) = \gamma_2(6; 3, 12, 18) = \gamma_3(6; 3, 12, 18) = 0, \varepsilon_1(6; 3, 12, 18) = 3, \varepsilon_2(6; 3, 12, 18) = \varepsilon_3(6; 3, 12, 18) = 6,$$

$$\theta(6; 3, 12, 18) = \frac{1}{2}(6 - 0) = 3, \text{deg}(\mathcal{O}_{C_2}(6)) = \frac{1}{3}(pt(3; 1, 2, 3) - pt(-3; 1, 2, 3)) =$$

$$\frac{1}{3}(3 - 0) = 1.$$

Now the germ of a point $P \in \text{Sing}(X)$ is isomorphic to:

$$(X, P) \cong \begin{cases} ((\mathbb{C}^2 / \langle \text{diag}(\zeta_2, \zeta_2) \rangle) \times \mathbb{C}, [\mathbf{0}] \times \{0\}), & \text{if } P \in C_1 \setminus \{Q\} \\ ((\mathbb{C}^2 / \langle \text{diag}(\zeta_3, \zeta_3^2) \rangle) \times \mathbb{C}, [\mathbf{0}] \times \{0\}), & \text{if } P \in C_2 \setminus \{Q\} \\ (\mathbb{C}^3 / \langle \text{diag}(\zeta_6, \zeta_6^2, \zeta_6^3) \rangle, [\mathbf{0}]), & \text{if } P = Q \end{cases}$$

We resolve an open neighbourhood of Q by means of one of the five toric crepant morphisms $Z(N_{G_Q}, \Sigma'_0(\mathcal{S}_i)) \rightarrow Z(N_{G_Q}, \Sigma_0)$, $G_Q \cong (\mathbb{Z}/6\mathbb{Z})$, corresponding to one of the five possible triangulations \mathcal{S}_i , $1 \leq i \leq 5$, of s_0 , as they are drawn in figure 6. Since these morphisms are compatible with the usual blow-ups along $\mathcal{N}_{C_1/X}$, $\mathcal{N}_{C_2/X}$, we can construct five (global) toroidal crepant desingularizations $\pi_i : Y_i \rightarrow X$ of X with $a(Q) = 1$, $h^{1,1}(Y_i) = 1 + (2 + 3) - 1 = 5$, $h^{1,2}(Y_i) = h^{1,2}(X) + (2 - 1) \cdot 1 + (3 - 1) \cdot 1 = 182 + 3 = 185$ (cf. (4.21), (4.22)) and topological Euler-Poincaré characteristic $e(Y_i) = 2(h^{1,1}(Y_i) - h^{1,2}(Y_i)) = 2 \cdot (5 - 185) = -360$. Over C_1, C_2 and Q are placed the exceptional prime divisors $D_1^{(i)}$, $\{D_2^{(i)}, D_3^{(i)}\}$ and $D_4^{(i)}$ respectively. (In the “toric picture” they are realized by D_{n_1} , $\{D_{n_2}, D_{n_3}\}$ and D_{n_4} , $\forall i, 1 \leq i \leq 5$, with $n_1 = (\frac{1}{2}, 0, \frac{1}{2})$, $n_2 = (\frac{1}{3}, \frac{2}{3}, 0)$, $n_3 = (\frac{2}{3}, \frac{1}{3}, 0)$, $n_4 = (\frac{1}{6}, \frac{2}{6}, \frac{3}{6})$, $e_1 = (1, 0, 0)$, $e_2 = (0, 1, 0)$, $e_3 = (0, 0, 1)$.)

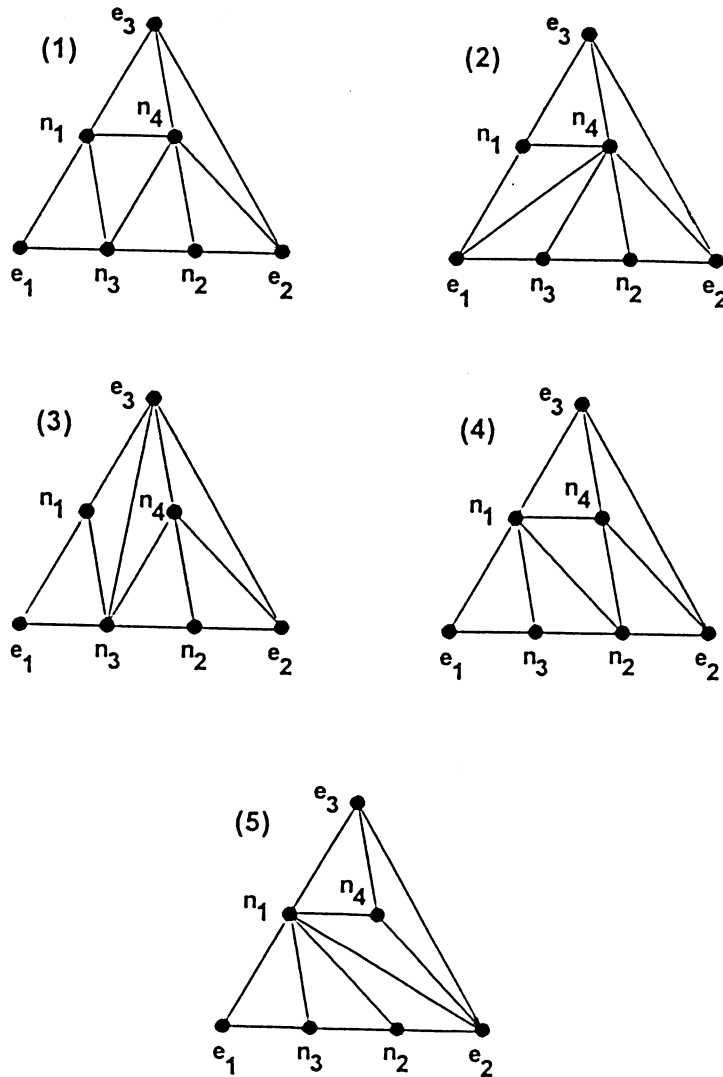

Fig.6

Thus,

$$\mathrm{Pic}_{\mathbb{Q}}(Y_i) \cong (\mathbb{Q}_{C_1}(\mathbf{L}_{Y_i})) \oplus (\oplus_{j=1}^4 \mathbb{Q}_{C_1}(\mathcal{O}_{Y_i}(D_j^{(i)})).$$

Moreover, it is easy to see that all five desingularization spaces are projective, i.e. that Y_i is a CY threefold, $\forall i, 1 \leq i \leq 5$. Note that Y_2, Y_3 and Y_4 are obtained from Y_1 after a single flop along the curves $\mathcal{C}(n_1, n_3)$, $\mathcal{C}(n_1, n_4)$ and $\mathcal{C}(n_3, n_4)$ respectively. Y_5 is nothing but Y_4 being flopped along $\mathcal{C}(n_2, n_4)$.

Proposition 6.1. Y_i and $Y_{i'}$ do not have the same diffeomorphism (resp. homotopy) type, $\forall i, i', 1 \leq i, i' \leq 5, i \neq i'$.

Proof. At first we compute the $5 \cdot \binom{7}{3} = 175$ intersection numbers which can be formed by triples of $\{\mathcal{B}_{Y_i} | 1 \leq i \leq 5\}$, as well as the images of the elements of these bases under $[c_2]_{Y_i}, 1 \leq i \leq 5$, by using the formulae of theorems 5.1., 5.3., 5.7., and 5.10. All formulae, up to (5.19) and (5.20) for C_2 , are now directly applicable if one takes account of the toric data of figure 6 and of the discussion preceding the formulation of prop. 6.1. For (5.19) and (5.20) we need, in addition, to compute $\deg(\mathcal{O}_{C_2'}(\theta(2 - \alpha_2^{(C_2)}; 3, 12, 18)))$ and $\deg(\mathcal{O}_{C_2'}(\theta(-1 + \alpha_2^{(C_2)}; 3, 12, 18)))$ respectively. Since $(\alpha_1^{(C_2)}, \alpha_2^{(C_2)}) = (1, 2)$, $\theta(0; 3, 12, 18) = 0$, $\gamma_1(1; 3, 12, 18) = 1$, $\gamma_2(1; 3, 12, 18) = \gamma_3(1; 3, 12, 18) = 0$, $\varepsilon_1(1; 3, 12, 18) = 0$, $\varepsilon_2(1; 3, 12, 18) = \varepsilon_3(1; 3, 12, 18) = 1$, we get $\theta(1; 3, 12, 18) = \frac{1}{2}(1 - 1) = 0$, which means that both of the regarded degrees vanish (cf. (5.12)).

The intersection numbers are given by the following table:

Nr.	int. numbers/ i	1	2	3	4	5
(1)	$(D_1^{(i)})^3$	-1	0	0	-2	-3
(2)	$((D_1^{(i)})^2 \cdot D_2^{(i)})$	0	0	0	-1	0
(3)	$((D_1^{(i)})^2 \cdot D_3^{(i)})$	-1	0	-2	0	0
(4)	$((D_1^{(i)})^2 \cdot D_4^{(i)})$	-1	-2	0	0	1
(5)	$(D_2^{(i)})^3$	0	0	0	-1	0
(6)	$((D_2^{(i)})^2 \cdot D_1^{(i)})$	0	0	0	-1	-2
(7)	$((D_2^{(i)}) \cdot D_3^{(i)})$	0	0	0	0	0
(8)	$((D_2^{(i)})^2 \cdot D_4^{(i)})$	-2	-2	-2	-1	0

(9)	$(D_3^{(i)})^3$	-1	0	-2	0	0
(10)	$((D_3^{(i)})^2 \cdot D_1^{(i)})$	-1	0	0	-2	-2
(11)	$((D_3^{(i)})^2 \cdot D_2^{(i)})$	0	0	0	0	0
(12)	$((D_3^{(i)})^2 \cdot D_4^{(i)})$	-1	-2	0	0	0
(13)	$(D_4^{(i)})^3$	7	6	8	8	9
(14)	$((D_4^{(i)})^2 \cdot D_1^{(i)})$	-1	0	0	-2	-3
(15)	$((D_4^{(i)})^2 \cdot D_2^{(i)})$	0	0	0	-1	0
(16)	$((D_4^{(i)})^2 \cdot D_3^{(i)})$	-1	0	-2	0	0
(17)	$\mathbf{L}_{Y_i}^3$	6	6	6	6	6
(18)	$((\mathbf{L}_{Y_i})^2 \cdot D_1^{(i)})$	0	0	0	0	0
(19)	$((\mathbf{L}_{Y_i})^2 \cdot D_2^{(i)})$	0	0	0	0	0
(20)	$((\mathbf{L}_{Y_i})^2 \cdot D_3^{(i)})$	0	0	0	0	0
(21)	$((\mathbf{L}_{Y_i})^2 \cdot D_4^{(i)})$	0	0	0	0	0
(22)	$(\mathbf{L}_{Y_i} \cdot (D_1^{(i)})^2)$	-2	-2	-2	-2	-2
(23)	$(\mathbf{L}_{Y_i} \cdot (D_2^{(i)})^2)$	-2	-2	-2	-2	-2
(24)	$(\mathbf{L}_{Y_i} \cdot (D_3^{(i)})^2)$	-2	-2	-2	-2	-2
(25)	$(\mathbf{L}_{Y_i} \cdot (D_4^{(i)})^2)$	0	0	0	0	0
(26)	$(D_1^{(i)} \cdot D_2^{(i)} \cdot D_3^{(i)})$	0	0	0	1	1
(27)	$(D_1^{(i)} \cdot D_2^{(i)} \cdot D_4^{(i)})$	0	0	0	1	0
(28)	$(D_1^{(i)} \cdot D_3^{(i)} \cdot D_4^{(i)})$	1	0	0	0	0
(29)	$(D_2^{(i)} \cdot D_3^{(i)} \cdot D_4^{(i)})$	1	1	1	0	0
(30)	$(\mathbf{L}_{Y_i} \cdot D_1^{(i)} \cdot D_2^{(i)})$	0	0	0	0	0
(31)	$(\mathbf{L}_{Y_i} \cdot D_1^{(i)} \cdot D_3^{(i)})$	0	0	0	0	0

(32)	$(L_{Y_i} \cdot D_1^{(i)} \cdot D_4^{(i)})$	0	0	0	0	0
(33)	$(L_{Y_i} \cdot D_2^{(i)} \cdot D_3^{(i)})$	1	1	1	1	1
(34)	$(L_{Y_i} \cdot D_2^{(i)} \cdot D_4^{(i)})$	0	0	0	0	0
(35)	$(L_{Y_i} \cdot D_3^{(i)} \cdot D_4^{(i)})$	0	0	0	0	0

Correspondingly, the images of the elements of the bases $\{B_{Y_i}, 1 \leq i \leq 5\}$ under $[c_2]_{Y_i}$ are given by the table:

Nr.	images/ i	1	2	3	4	5
(1)	$[c_2]_{Y_i}(D_1^{(i)})$	2	0	0	4	6
(2)	$[c_2]_{Y_i}(D_2^{(i)})$	0	0	0	2	0
(3)	$[c_2]_{Y_i}(D_3^{(i)})$	2	0	4	0	0
(4)	$[c_2]_{Y_i}(D_4^{(i)})$	-2	0	-4	-4	-6
(5)	$[c_2]_{Y_i}(L_{Y_i})$	72	72	72	72	72

In the next step we consider the testing bilinear forms of Y_i

$$\beta_{Y_i}^{\mathbb{Q}} : (\text{Sym}^2(\text{Pic}_{\mathbb{Q}}(Y_i)))^2 \rightarrow \mathbb{Q}, 1 \leq i \leq 5.$$

$\text{Sym}^2(\text{Pic}_{\mathbb{Q}}(Y_i))$ has dimension $\frac{h^{1,1}(Y_i)(h^{1,1}(Y_i)+1)}{2} = \frac{5 \cdot 6}{2} = 15$.

Let \mathcal{M}_i denote the symmetric matrix $\{\beta_{Y_i}^{\mathbb{Q}}(b_s^{(i)}, b_t^{(i)}) | 1 \leq s, t \leq 15\}$ defined by the ordered basis

$$\left\{ \begin{aligned} &b_1^{(i)} := (L_{Y_i}, L_{Y_i}), b_2^{(i)} := (L_{Y_i}, D_1^{(i)}), b_3^{(i)} := (L_{Y_i}, D_2^{(i)}), b_4^{(i)} := (L_{Y_i}, D_3^{(i)}), \\ &b_5^{(i)} := (L_{Y_i}, D_4^{(i)}), b_6^{(i)} := (D_1^{(i)}, D_1^{(i)}), b_7^{(i)} := (D_1^{(i)}, D_2^{(i)}), b_8^{(i)} := (D_1^{(i)}, D_3^{(i)}), \\ &b_9^{(i)} := (D_1^{(i)}, D_4^{(i)}), b_{10}^{(i)} := (D_2^{(i)}, D_2^{(i)}), b_{11}^{(i)} := (D_2^{(i)}, D_3^{(i)}), b_{12}^{(i)} := (D_2^{(i)}, D_4^{(i)}), \\ &b_{13}^{(i)} := (D_3^{(i)}, D_3^{(i)}), b_{14}^{(i)} := (D_3^{(i)}, D_4^{(i)}), b_{15}^{(i)} := (D_4^{(i)}, D_4^{(i)}) \end{aligned} \right\}$$

of $\text{Sym}^2(\text{Pic}_{\mathbb{Q}}(Y_i))$. We compute \mathcal{M}_i 's by the above tables. For typographical reasons we write the entries of each of their lines between commas:

$$\mathcal{M}_1 = \left(\begin{array}{l} [1728, 12, 0, 12, -12, -288, 0, 0, 0, -288, 144, 0, -288, 0, 0], \\ [12, -288, 0, 0, 0, -84, 0, -76, -68, -4, 2, 0, -76, 72, -72], \\ [0, 0, -288, 144, 0, 0, -4, 2, 0, -6, -4, -140, 4, 70, 0], \\ [12, 0, 144, -288, 0, -76, 2, -76, 72, -4, 4, 70, -84, -68, -72], \\ [-12, 0, 0, 0, 0, -68, 0, 72, -72, -140, 70, 0, -68, -72, 504], \\ [-288, -84, 0, -76, -68, -8, 0, -8, -4, 0, 0, 0, -8, 4, 0], \\ [0, 0, -4, 2, 0, 0, 0, 0, 0, 0, 0, -4, 0, 2, 0] \\ [0, -76, 2, -76, 72, -8, 0, -8, 4, 0, 0, 2, -8, 4, -8], \\ [0, -68, 0, 72, -72, -4, 0, 4, 0, -4, 2, 0, 4, -8, 11] \\ [-288, -4, -6, -4, -140, 0, 0, 0, -4, 0, 0, 0, 0, -4, 6], \\ [144, 2, -4, 4, 70, 0, 0, 0, 2, 0, 0, -4, 0, 4, -4], \\ [0, 0, -140, 70, 0, 0, -4, 2, 0, 0, -4, 6, 4, -4, 0] \\ [-288, -76, 4, -84, -68, -8, 0, -8, 4, 0, 0, 4, -8, -4, 0], \\ [0, 72, 70, -68, -72, 4, 2, 4, -8, -4, 4, -4, -4, 0, 20], \\ [0, -72, 0, -72, 504, 0, 0, -8, 11, 6, -4, 0, 0, 20, -56] \end{array} \right)$$

$$\mathcal{M}_2 = \left(\begin{array}{l} [1728, 0, 0, 0, 0, -288, 0, 0, 0, -288, 144, 0, -288, 0, 0], \\ [0, -288, 0, 0, 0, -6, 0, 0, -144, 0, 0, 0, 0, 0, 0], \\ [0, 0, -288, 144, 0, 0, 0, 0, 0, -6, 0, -144, 0, 72, 0], \\ [0, 0, 144, -288, 0, 0, 0, 0, 0, 0, 0, 72, 0, -144, 0], \\ [0, 0, 0, 0, 0, 0, 0, 0, 0, -144, 72, 0, 144, 0, 432], \\ [-288, -6, 0, 0, 0, 0, 0, 0, 0, 0, 0, 0, 0, 0, 0], \\ [0, 0, 0, 0, 0, 0, 0, 0, 0, 0, 0, 0, 0, 0, 0], \\ [0, 0, 0, 0, 0, 0, 0, 0, 0, 0, 0, 0, 0, 0, 0], \\ [0, -144, 0, 0, 0, 0, 0, 0, 0, 0, 0, 0, 0, 0, 0], \\ [-288, 0, -6, 0, -144, 0, 0, 0, 0, 0, 0, 0, 0, 0, 0], \\ [144, 0, 0, 0, 72, 0, 0, 0, 0, 0, 0, 0, 0, 0, 0], \\ [0, 0, -144, 72, 0, 0, 0, 0, 0, 0, 0, 0, 0, 0, 0], \\ [-288, 0, 0, 0, -144, 0, 0, 0, 0, 0, 0, 0, 0, 0, 0], \\ [0, 0, 72, -144, 0, 0, 0, 0, 0, 0, 0, 0, 0, 0, 0], \\ [0, 0, 0, 0, 432, 0, 0, 0, 0, 0, 0, 0, 0, 0, 0] \end{array} \right)$$

$$\mathcal{M}_3 = \left(\begin{array}{l} [1728, 0, 0, 24, -24, -288, 0, 0, 0, -288, 144, 0, -288, 0, 0], \\ [0, -288, 0, 0, 0, -6, 0, -152, 8, 0, 0, 0, 0, 0, 0], \\ [0, 0, -288, 144, 0, 0, 0, 0, 0, -6, -8, -136, 8, 68, 0], \\ [24, 0, 144, -288, 0, -152, 0, 0, 0, -8, 8, 68, -168, 8, -144], \\ [-24, 0, 0, 0, 0, 8, 0, 0, 0, -136, 68, 0, 8, -144, 576], \\ [-288, -6, 0, -152, 8, 0, 0, 0, 0, 0, 0, 0, 0, -16, 8, 0], \\ [0, 0, 0, 0, 0, 0, 0, 0, 0, 0, 0, 0, 0, 0, 0, 0], \\ [0, -152, 0, 0, 0, 0, 0, -16, 8, 0, 0, 0, 0, 0, 0, 0], \\ [0, 8, 0, 0, 0, 0, 0, 8, 0, 0, 0, 0, 0, 0, 0, 0], \\ [-288, 0, -6, -8, -136, 0, 0, 0, 0, 0, 0, 0, 0, -8, 16], \\ [144, 0, -8, 8, 68, 0, 0, 0, 0, 0, 0, -8, 0, 8, -8], \\ [0, 0, -136, 68, 0, 0, 0, 0, 0, 0, -8, 16, 8, -8, 0], \\ [-288, 0, 8, -168, 8, -16, 0, 0, 0, 0, 0, 8, -32, 8, -16], \\ [0, 0, 68, 8, -144, 8, 0, 0, 0, -8, 8, -8, 8, -16, 56], \\ [0, 0, 0, -144, 576, 0, 0, 0, 0, 16, -8, 0, -16, 56, -128] \end{array} \right)$$

$$\mathcal{M}_4 = \begin{pmatrix} [1728, 24, 12, 0, -24, -288, 0, 0, 0, -288, 144, 0, -288, 0, 0], \\ [24, -288, 0, 0, 0, -168, -76, 0, 8, -80, 76, 72, -152, 0, -144], \\ [12, 0, -288, 144, 0, -76, -80, 76, 72, -84, 4, -64, -4, -4, -72], \\ [0, 0, 144, -288, 0, 0, 76, -152, 0, 4, -4, -4, 0, 8, 0], \\ [-24, 0, 0, 0, 0, 8, 72, 0, -144, -64, -4, -72, 8, 0, 576], \\ [-288, -168, -76, 0, 8, -32, -16, 0, 8, -12, 8, 12, -16, 0, -16], \\ [0, -76, -80, 76, 72, -16, -12, 8, 12, -10, 4, 4, -4, -4, -6], \\ [0, 0, 76, -152, 0, 0, 8, -16, 0, 4, -4, -4, 0, 8, 0], \\ [0, 8, 72, 0, -144, 8, 12, 0, -16, 4, -4, -6, 8, 0, 26], \\ [-288, -80, -84, 4, -64, -12, -10, 4, 4, -8, 0, -2, 0, 0, 4], \\ [144, 76, 4, -4, -4, 8, 4, -4, -4, 0, 0, 0, 0, 0, 0], \\ [0, 72, -64, -4, -72, 12, 4, -4, -6, -2, 0, 4, 0, 0, 28], \\ [-288, -152, -4, 0, 8, -16, -4, 0, 8, 0, 0, 0, 0, 0, 0], \\ [0, 0, -4, 8, 0, 0, -4, 8, 0, 0, 0, 0, 0, 0, 0], \\ [0, -144, -72, 0, 576, -16, -6, 0, 26, 4, 0, 28, 0, 0, -128] \end{pmatrix}$$

$$\mathcal{M}_5 = \begin{pmatrix} [1728, 36, 0, 0, -36, -288, 0, 0, 0, -288, 144, 0, -288, 0, 0], \\ [36, -288, 0, 0, 0, -252, 0, 0, 84, -156, 78, 0, -156, 0, -216], \\ [0, 0, -288, 144, 0, 0, -156, 78, 0, -6, 0, 12, 0, -6, 0], \\ [0, 0, 144, -288, 0, 0, 78, -156, 0, 0, 0, -6, 0, 12, 0], \\ [-36, 0, 0, 0, 0, 84, 0, 0, -216, 12, -6, 0, 12, 0, 648], \\ [-288, -252, 0, 0, 84, -72, 0, 0, 36, -24, 12, 0, -24, 0, -48], \\ [0, 0, -156, 78, 0, 0, -24, 12, 0, 0, 0, 12, 0, -6, 0], \\ [0, 0, 78, -156, 0, 0, 12, -24, 0, 0, 0, -6, 0, 12, 0], \\ [0, 84, 0, 0, -216, 36, 0, 0, -48, 12, -6, 0, 12, 0, 45], \\ [-288, -156, -6, 0, 12, -24, 0, 0, 12, 0, 0, 0, 0, 0, 0], \\ [144, 78, 0, 0, -6, 12, 0, 0, -6, 0, 0, 0, 0, 0, 0], \\ [0, 0, 12, -6, 0, 0, 12, -6, 0, 0, 0, 0, 0, 0, 0], \\ [-288, -156, 0, 0, 12, -24, 0, 0, 12, 0, 0, 0, 0, 0, 0], \\ [0, 0, -6, 12, 0, 0, -6, 12, 0, 0, 0, 0, 0, 0, 0], \\ [0, -216, 0, 0, 648, -48, 0, 0, 45, 0, 0, 0, 0, 0, -216] \end{pmatrix}$$

Using the computer programme MAPLE, we find their ranks:

$$\text{rk}(\mathcal{M}_1) = \text{rk}(\mathcal{M}_3) = 14, \text{rk}(\mathcal{M}_2) = 10, \text{rk}(\mathcal{M}_4) = \text{rk}(\mathcal{M}_5) = 13.$$

For $i \in \{1, \dots, 5\}$, let \mathfrak{Q}_i denote the quadratic form being associated to \mathcal{M}_i , $(\mathfrak{n}_+^{(i)}, \mathfrak{n}_-^{(i)}, \mathfrak{n}_0^{(i)})$ the signature data of \mathfrak{Q}_i , $\text{chp}_i(x) = \sum_{j=0}^{15} \mu_j^{(i)} x^j$ the characteristic polynomial of \mathcal{M}_i and $\lambda_1^{(i)}, \dots, \lambda_{15}^{(i)}$ the corresponding eigenvalues. Obviously, $\mathfrak{n}_0^{(1)} = \mathfrak{n}_0^{(3)} = 1$, $\mathfrak{n}_0^{(2)} = 5$, $\mathfrak{n}_0^{(4)} = \mathfrak{n}_0^{(5)} = 2$. Since \mathcal{M}_i , $1 \leq i \leq 5$, are real symmetric matrices, they have only *real* eigenvalues. Furthermore, according to the spectral theorem, the triples $(\mathfrak{n}_+^{(i)}, \mathfrak{n}_-^{(i)}, \mathfrak{n}_0^{(i)})$ give the numbers of positive, negative and vanishing eigenvalues of \mathcal{M}_i respectively.

Let now $\lambda_{14}^{(4)}, \lambda_{15}^{(4)}, \lambda_{14}^{(5)}$ and $\lambda_{15}^{(5)}$ be the vanishing eigenvalues of \mathcal{M}_4 and \mathcal{M}_5 . By Viète's root theorem, we get $\mu_2^{(4)} = -\lambda_1^{(4)} \dots \lambda_{13}^{(4)}$ and $\mu_2^{(5)} = -\lambda_1^{(5)} \dots \lambda_{13}^{(5)}$. If

$(n_+^{(4)}, n_-^{(4)}) = (n_+^{(5)}, n_-^{(5)})$, then we should have $\text{sgn}(\mu_2^{(4)}) = (-1)^{n_-^{(4)}+1} = (-1)^{n_-^{(5)}+1} = \text{sgn}(\mu_2^{(5)})$, which would contradict MAPLE's computations:

$$\begin{aligned}\mu_2^{(4)} &= -576198190423640899584000 < 0 \\ \mu_2^{(5)} &= 58528305311105828782080 > 0\end{aligned}$$

Hence Ω_4 and Ω_5 (resp. $\beta_{Y_4}^{\mathbb{R}}$ and $\beta_{Y_5}^{\mathbb{R}}, \beta_{Y_4}^{\mathbb{Q}}$ and $\beta_{Y_5}^{\mathbb{Q}}$) are inequivalent. Unfortunately, $(n_+^{(1)}, n_-^{(1)}, n_0^{(1)}) = (n_+^{(3)}, n_-^{(3)}, n_0^{(3)}) = (7, 7, 1)$ and the above trick cannot be applied to \mathcal{M}_1 and \mathcal{M}_3 . Nevertheless, we can write $\text{Sym}^2(\text{Pic}_{\mathbb{Q}}(Y_1)) = V_1 \oplus W_1, \text{Sym}^2(\text{Pic}_{\mathbb{Q}}(Y_3)) = V_3 \oplus W_3$, where W_1 and W_3 denote the kernels of the linear maps corresponding to \mathcal{M}_1 and \mathcal{M}_3 , and V_1, V_3 the nondegeneracy loci, and compare the so arising nondegenerate quadratic forms $\tilde{\Omega}_1 := \Omega_1|_{V_1}$ and $\tilde{\Omega}_3 := \Omega_3|_{V_3}$ of rank 14 over \mathbb{Q} . Note that

$$\begin{aligned}W_1 &= \langle (0, 0, 0, 0, 0, 1, -4, -2, 0, 0, 4, 0, 1, 0, 0) \rangle \quad \text{and} \\ W_3 &= \langle (0, 0, 0, 0, 0, 0, 1, 0, 0, 0, 0, 0, 0, 0, 0) \rangle.\end{aligned}$$

In fact, $\tilde{\Omega}_3$ corresponds to the symmetric (14×14) -matrix $\tilde{\mathcal{M}}_3$ coming from \mathcal{M}_3 after deletion of the 7-th column and of the 7-th row. If we regard $\{e_1, \dots, e_6, \text{the generator of } W_1, e_8, \dots, e_{15}\}$ as a new basis for \mathbb{Q}^{15} , then the matrix of the quadratic form $\tilde{\Omega}_1$ w.r.t. it will be $S^T \mathcal{M}_1 S$, where S denotes the change of basis matrix. Deleting again the zero 7-th column and 7-th row we get the matrix:

$$\tilde{\mathcal{M}}_1 = \begin{pmatrix} [1728, 12, 0, 12, -12, -288, 0, 0, -288, 144, 0, -288, 0, 0], \\ [12, -288, 0, 0, 0, -84, -76, -68, -4, 2, 0, -76, 72, -72], \\ [0, 0, -288, 144, 0, 0, 2, 0, -6, -4, -140, 4, 70, 0], \\ [12, 0, 144, -288, 0, -76, -76, 72, -4, 4, 70, -84, -68, -72], \\ [-12, 0, 0, 0, 0, -68, 72, -72, -140, 70, 0, -68, -72, 504], \\ [-288, -84, 0, -76, -68, -8, -8, -4, 0, 0, 0, -8, 4, 0], \\ [0, -76, 2, -76, 72, -8, -8, 4, 0, 0, 2, -8, 4, -8], \\ [0, -68, 0, 72, -72, -4, 4, 0, -4, 2, 0, 4, -8, 11], \\ [-288, -4, -6, -4, -140, 0, 0, -4, 0, 0, 0, 0, -4, 6], \\ [144, 2, -4, 4, 70, 0, 0, 2, 0, 0, -4, 0, 4, -4], \\ [0, 0, -140, 70, 0, 0, 2, 0, 0, -4, 6, 4, -4, 0], \\ [-288, -76, 4, -84, -68, -8, -8, 4, 0, 0, 4, -8, -4, 0], \\ [0, 72, 70, -68, -72, 4, 4, -8, -4, 4, -4, -4, 0, 20], \\ [0, -72, 0, -72, 504, 0, -8, 11, 6, -4, 0, 0, 20, -56] \end{pmatrix}$$

If $\tilde{\Omega}_1$ and $\tilde{\Omega}_3$ were equivalent as \mathbb{Q} -quadratic forms, then $\det(\tilde{\mathcal{M}}_1)$ and $\det(\tilde{\mathcal{M}}_3)$ would be equal up to multiplication by the square of a number $\in (\mathbb{Q} \setminus \{0\})$. Luckily, by MAPLE we get

$$\begin{aligned}\det(\tilde{\mathcal{M}}_1) &= -14286537432760320000, \\ \det(\tilde{\mathcal{M}}_3) &= -136139852325977063424,\end{aligned}$$

and

$$\left(\frac{\det(\tilde{\mathcal{M}}_1)}{\det(\tilde{\mathcal{M}}_3)} \right)^{\frac{1}{2}} = \frac{25}{788768} (2119)^{\frac{1}{2}} (49298)^{\frac{1}{2}} \notin \mathbb{Q},$$

which leads to the desirable contradiction. \square

Remarks 6.2. (i) We should mention here, that if we wish (e.g. in another example) to compare two *nondegenerate rational* quadratic forms with *identical* signature data, whose ratio of determinants of their structure matrices w.r.t. our bases has *rational* square root, then we have to make use of additional *local invariants* involving the *Hilbert symbol* of numbers taken from the field \mathbb{Q}_p of p -adic numbers. See Serre [109, Cor. of p. 44].

(ii) It is now obvious from the above that for a given c.i. $X = X_{\mathbf{d}} \subset \mathbb{P}^{m-1}(\mathbf{w})$ (as in §5) with at least two distinct toroidal crepant desingularizations, one can develop a *formal comparison algorithm* (or, so to say, a *weak C^∞ -classification algorithm*) for all Y 's. Let us describe it in broad outline:

Step 1: Find the number η_X by (2.24) and the singular locus $\text{Sing}(X)$ of X by (4.1), as well as the type of the c.q.s. of each of its dissident points using lemma 4.2.

Step 2: Draw a picture for the “toric triangles” corresponding to the dissident points of X and determine on them all the “new” fixed vertices which are due to our group actions (cf. §3). After that construct all the possible distinct subdivisions of these triangles with respect to these new vertices. (For *linear time algorithms* for the sorting of subdivisions of a plane triangle or, more general, of a simple polygon into smaller triangles with prescribed vertices, see Clarkson et al. [19], Chazelle [18] and further references given in these articles.)

Step 3: Consider an arbitrary pair (Y_1, Y_2) consisting of two distinct toroidal crepant desingularizations (4.16) of X . Use step 1, the first part of step 2 and the formulae of §5, in order to specify the entries of the symmetric $\left(\frac{h^{1,1}(h^{1,1}+1)}{2} \times \frac{h^{1,1}(h^{1,1}+1)}{2} \right)$ -matrices, say \mathcal{M}_1 and \mathcal{M}_2 , coming from the evaluations of the testing bilinear forms $\beta_{Y_1}^{\mathbb{Q}}, \beta_{Y_2}^{\mathbb{Q}}$ at the pairs formed by members of the natural ordered bases of $\text{Sym}^2(\text{Pic}_{\mathbb{Q}}(Y_i))$, $i = 1, 2$. If $\mathcal{M}_1, \mathcal{M}_2$ have different ranks or different signature data or - in the nondegenerate case - different discriminants, then Y_1 and Y_2 will be non diffeomorphic. In the case, where the above invariants are identical, try to use the “determinant trick” or p -adics (as it is explained in (i)). If this is still not enough to distinguish the diffeomorphism types of Y_1 and Y_2 , then try to make use of *another* testing (real or rational) quadratic form and compare again the corresponding invariants.

Step 4: If none of the criteria being introduced in step 3 is able to give a definitive answer to the question, if Y_1 and Y_2 are of different type or not, then throw (Y_1, Y_2) into the “basket” of the “undecided cases”. (We do not know any example of a pair

(Y_1, Y_2) belonging to the undecided cases, and we conjecture that the above basket is probably empty !)

Step 5: Repeat for all pairs (Y_1, Y_2) of the second part of step 2 the procedures of the other steps and close the flow chart of our algorithm.



**§ 7. Appendix: On the Combinatorics concerning the Weighted Partitions and the Counting of Integral Points of a Polyhedron.
From Euler's "Partitio Numerorum" to Ehrhart Polynomials.**

Let $\mathbf{w} = (w_1, \dots, w_m) \in \mathbb{N}^m$ be again a system of "weights". For a fixed $n \in \mathbb{N}_0$ we define:

$$\begin{aligned} \text{PT}(n; \mathbf{w}) &:= \{(\lambda_1, \dots, \lambda_m) \in \mathbb{N}_0^m \mid \sum_{i=1}^m \lambda_i w_i = n\} \\ \text{PT}^+(n; \mathbf{w}) &:= \{(\lambda_1, \dots, \lambda_m) \in \mathbb{N}^m \mid \sum_{i=1}^m \lambda_i w_i = n\} \end{aligned}$$

and $pt(n; \mathbf{w}) := \#\text{PT}(n; \mathbf{w})$, $pt^+(n; \mathbf{w}) := \#\text{PT}^+(n; \mathbf{w})$. Obviously, $pt^+(n; \mathbf{w}) = pt(n - \sum_{i=1}^m w_i; \mathbf{w})$.

The elements of $\text{PT}(n; \mathbf{w})$ and $\text{PT}^+(n; \mathbf{w})$ can always be found by means of standard polynomial time algorithms within the framework of the theory of integer linear programming (see Schrijver [106]). Nevertheless, the *precise* determination of $pt(n; \mathbf{w})$ or $pt^+(n; \mathbf{w})$ as a "closed" functional expression of n and \mathbf{w} is indeed a very subtle problem. $pt(n; \mathbf{w})$ has the following equivalent interpretations:

(a) *arithmetical-combinatorial interpretation*: $pt(n; \mathbf{w})$ equals the number of non-negative integral solutions of a linear diophantine equation and expresses the *denumerant* of the *weighted partitions* of n w.r.t. w_1, \dots, w_m .

(b) *geometrical-combinatorial interpretation*: $pt(n; \mathbf{w})$ gives the number of the integral points of the rational polyhedron

$$(7.1) \quad \mathbf{P}(n; \mathbf{w}) := \{(x_1, \dots, x_m) \in \mathbb{R}^m \mid \sum_{i=1}^m w_i x_i = n, x_i \geq 0, \forall i, 1 \leq i \leq m\}$$

with vertices $(\frac{n}{w_1}, 0, \dots, 0), \dots, (0, 0, \dots, 0, \frac{n}{w_m})$. Note that $\mathbf{P}(n; \mathbf{w})$ can be represented as the *dilation* $\mathbf{P}(n; \mathbf{w}) = n \cdot \Pi(\mathbf{w})$ of the polyhedron $\Pi(\mathbf{w})$ by the factor n , where:

$$(7.2) \quad \Pi(\mathbf{w}) := \{(y_1, \dots, y_m) \in \mathbb{R}^m \mid \sum_{i=1}^m w_i y_i = 1, y_i \geq 0, \forall i, 1 \leq i \leq m\}$$

with vertices $(\frac{1}{w_1}, 0, \dots, 0), \dots, (0, \dots, 0, \frac{1}{w_m})$.

Since $(1 - x^{w_i})^{-1} = \sum_{\nu=0}^{\infty} x^{w_i \nu}$, $pt(n; \mathbf{w})$ is exactly the n -th coefficient of the generating function of $\mathbf{F}(x) := \prod_{i=1}^m (1 - x^{w_i})^{-1}$ which was introduced by the formula

(2.19) in § 2. If we define $\tilde{pt}(n; \mathbf{w})$ to be $pt(n; \mathbf{w})$ for $n \in \mathbb{N}_0$, and to be given via the combinatorial identity ([111, p. 206])

$$(7.3) \quad \sum_{n=1}^{\infty} \tilde{pt}(-n; \mathbf{w}) x^n = -\mathbf{F}(x^{-1}), \quad \text{for } n \in \mathbb{N},$$

(which means that we choose an extension of $pt(n; \mathbf{w})$ on the whole \mathbb{Z} *different* from the one introduced in 2.26.), then we get the *reciprocity relation*:

$$(7.4) \quad pt^+(n; \mathbf{w}) = (-1)^{m-1} \tilde{pt}(-n; \mathbf{w}) \quad (\text{cf. [35]}).$$

We are basically interested in the pt -functions, because they constitute the “combinatorial cornerstones” of our formulae (2.20), (4.22), (5.2), (5.3), (5.12), (5.18), (5.19), (5.20) and (5.21). (Furthermore, $\text{PT}(d; \mathbf{w}) \setminus \{0\}$ is nothing but the parameter space of all quasihomogeneous monomials of degree d w.r.t. \mathbf{w} .) The purpose of this appendix is to emphasize the complexity of pt 's, to make some brief historical remarks, to remind certain (mostly forgotten) combinatorial formulae for their computation, and to connect them with recent developments of the modern theory of geometric invariants.

Let us regard the above interpretation (a) as our starting-point. The pt -functions were first considered 1748 by Euler in his famous work [40]. He placed pt 's among the most central themes of his “Partitio Numerorum”. Euler himself studied the case where $w_i = i, \forall i, 1 \leq i \leq m$ (and which, from now on, will be referred as *Eulerian case*) and gave some preliminary computational rules. During the 19th century, the investigations of these functions played a crucial role in number theory and in invariant and partition theory. (For extensive historical comments for this period the reader is referred to Dickson's renowned treatment [29], Ch. III. Books which devote substantial extracts to pt 's or related functions, from the point of view not only of the classical but also of the modern partition theory, are, among others, those of Riordan [100], Comtet [20], Andrews [3] and Stanley [111].)

Euler's researches were mainly continued by Cayley [17] (1856), Sylvester [115], [116] (1857, 1882), Laguerre [80] (1876-7), Weihrauch [123], [124] (1875, 1877) and Glaisher [48] (1909). One of their very first results is that $pt(n; \mathbf{w})$ (resp. $pt^+(n; \mathbf{w})$) can be written as a *quasipolynomial* of degree $m - 1$:

$$(7.5) \quad pt(n; \mathbf{w}) = \sum_{k=0}^{m-1} c_{m-1-k}(n; \mathbf{w}) n^{m-1-k},$$

which means that the coefficients $c_{m-1-k}(n; \mathbf{w})$ are *periodic functions* (with integer periods) or, equivalently, that there exists an $N \in \mathbb{N}$ and polynomials f_0, f_1, \dots, f_{N-1} , such that $pt(n; \mathbf{w}) = f_j(n; \mathbf{w})$ whenever $n \equiv j \pmod{N}$.

They also used the splitting

$$(7.6) \quad pt(n; \mathbf{w}) = \Phi(n'; \mathbf{w}) + \Psi(n; \mathbf{w})$$

where $\Phi(n'; \mathbf{w})$ denotes a polynomial in the variable $n' := n + \frac{1}{2} \sum_{i=1}^m w_i$ (with *constant* coefficients) and $\Psi(n; \mathbf{w})$ the *purely periodic part* of $pt(n; \mathbf{w})$.

The asymptotics of pt 's are described by the following:

Theorem 7.1. (Laguerre, Schur) The pt -function behaves asymptotically like:

$$(7.7) \quad \lim_{n \rightarrow \infty} \frac{pt(n; \mathbf{w})}{n^{m-1}} = c_{m-1}(n; \mathbf{w}) = \frac{1}{(m-1)! (\prod_{i=1}^m w_i)}$$

Theorem 7.2. (Erdős-Lehner [39], Szekeres [117]) In the Eulerian case, for big n 's and $m = o(\sqrt[3]{n})$ (or even for $m = o(\sqrt{n})$), we have:

$$(7.8) \quad pt(n; 1, 2, \dots, m) \sim \frac{1}{m!} \binom{n-1}{m-1} \sim \frac{n^{m-1}}{(m-1)! m!}$$

In special cases, one can compute $pt(n; \mathbf{w})$ or $pt^+(n; \mathbf{w})$ very easily. For example, if $w_1 = \dots = w_m = 1$, we get directly the binomial coefficients:

$$pt(n; \mathbf{1}) = \binom{n+m-1}{n}, \quad pt^+(n; \mathbf{1}) = \binom{n-1}{n-m}.$$

On the other hand for $n = m$, we have:

Proposition 7.3. (Formula of Fergola (1863) and Sardi (1865)). If $n = m$, the number $pt^+(n; \mathbf{w})$ is given by the formula:

$$(7.9) \quad pt^+(n; \mathbf{w}) = \frac{1}{n!} \det(M),$$

where M denotes the $(n-1) \times (n-1)$ -matrix:

$$\begin{pmatrix} s_1 s_{n-1} + s_n & -s_1 & -s_2 & -s_3 & \dots & -s_{n-3} & -s_{n-2} \\ s_1 s_{n-2} + s_{n-1} & n-1 & -s_1 & -s_2 & \dots & -s_{n-4} & -s_{n-3} \\ s_1 s_{n-3} + s_{n-2} & 0 & n-2 & -s_1 & \dots & -s_{n-5} & -s_{n-4} \\ s_1 s_{n-4} + s_{n-3} & 0 & 0 & n-3 & \dots & -s_{n-6} & -s_{n-5} \\ \dots & \dots & \dots & \dots & \dots & \dots & \dots \\ s_1 s_2 + s_3 & 0 & 0 & 0 & \dots & 3 & -s_1 \\ s_1^2 + s_2 & 0 & 0 & 0 & \dots & 0 & 2 \end{pmatrix}$$

while s_i is the sum of those divisors of i which occur among w_1, \dots, w_n . (In the Eulerian case, s_i becomes the sum of all divisors of i , $1 \leq i \leq n$).

The first *general* computational method for the pt 's, due to Cayley, Sylvester and Glaisher, is based on the decomposition of $F(x)$ into *partial fractions*. $pt(n; \mathbf{w})$ is written as a sum of "waves" giving the coefficients of $\frac{1}{x}$ in the development (in ascending powers of x) of certain fractions depending on various roots of unity. The purely periodic part $\Psi(n; \mathbf{w})$ of $pt(n; \mathbf{w})$ in (7.6) is described in terms of "circulating functions", which have been introduced by Herschel in [62]. The "calculus" with these circulators seems to be extremely complicated and belongs without doubt to the (partially undecoded) "19-th century mystics". For an introduction to it we refer to the "Lehrbuch der Combinatorik" of Netto [92, § 84-95, pp. 140-158].

Weihrauch's computational technique [123], when w_i 's are pairwise coprime, was somehow different and was complemented 90 years later by Ehrhart [35], [37], who discovered some beautiful trigonometric expressions for $\Psi(n; \mathbf{w})$.

Theorem 7.4. (Formulae of Weihrauch and Ehrhart). Let w_1, \dots, w_m be pairwise coprime. Then the first summand $\Phi(n'; \mathbf{w})$ of $pt(n; \mathbf{w})$ in the expression (7.6) is a polynomial of degree $m - 1$. In particular, if $2 \leq m \leq 6$, we have:

$$\text{For } m = 2 : \quad \Phi(n'; \mathbf{w}) = (w_1 w_2)^{-1} n'$$

$$\text{For } m = 3 : \quad \Phi(n'; \mathbf{w}) = (2w_1 w_2 w_3)^{-1} \left(n'^2 - \frac{1}{12} \left(\sum_{i=1}^3 w_i^2 \right) \right)$$

$$\text{For } m = 4 : \quad \Phi(n'; \mathbf{w}) = (6 w_1 w_2 w_3 w_4)^{-1} \left(n'^3 - \frac{1}{4} \left(\sum_{i=1}^4 w_i^2 \right) n' \right)$$

$$\text{For } m = 5 : \quad \Phi(n'; \mathbf{w}) =$$

$$(24 \prod_{i=1}^5 w_i)^{-1} \left\{ n'^4 - \left(\frac{1}{2} \sum_{i=1}^5 w_i^2 \right) n'^2 + \frac{1}{24} \left[\frac{1}{2} \left(\sum_{i=1}^5 w_i^2 \right)^2 + \frac{1}{5} \left(\sum_{i=1}^5 w_i^4 \right) \right] \right\}$$

$$\text{For } m = 6 : \quad \Phi(n'; \mathbf{w}) =$$

$$(120 \prod_{i=1}^6 w_i)^{-1} \left\{ n'^5 - \left(\frac{5}{6} \sum_{i=1}^6 w_i^2 \right) n'^3 + \frac{5}{24} \left[\frac{1}{2} \left(\sum_{i=1}^6 w_i^2 \right)^2 + \frac{1}{5} \left(\sum_{i=1}^6 w_i^4 \right) \right] n' \right\}$$

Moreover, the second summand in (7.6) can be written as

$$\Psi(n; \mathbf{w}) = \sum_{i=1}^m \psi_{w_i}(n),$$

$$\text{where } \psi_{w_i}(n) := \frac{1}{2^{m-2} w_i} \sum_{\rho=1}^{\frac{1}{2}(w_i-1)} \kappa(\rho) \quad (\text{for } w_i \text{ odd})$$

$$\psi_{w_i}(n) := \frac{(-1)^n}{2^{m-1} w_i} + \frac{1}{2^{m-2} w_i} \sum_{\rho=1}^{\frac{1}{2}(w_i-2)} \kappa(\rho) \quad (\text{for } w_i \text{ even})$$

are functions of period w_i and

$$\kappa(\rho) := \cos \left[\left(\frac{m-1}{2} - \frac{1}{w_i} \left(2n + \sum_{\substack{j=1 \\ j \neq i}}^m w_j \right) \rho \right) \pi \right] \left[\prod_{\substack{j=1 \\ j \neq i}}^m \sin \left(\frac{\pi w_j}{w_i} \rho \right) \right]^{-1}.$$

On the other hand, $pt^+(n; \mathbf{w})$ obeys to the reciprocity law:

$$pt^+(n; \mathbf{w}) = (-1)^{m-1} \Phi \left(\sum_{i=1}^m w_i - n'; \mathbf{w} \right) + (-1)^{m-1} \Psi(-n; \mathbf{w}).$$

Unfortunately, the above condition which has to be satisfied by the weights is very restrictive as it covers, for instance, only the case in which we compute $h^0(X, \mathcal{O}_X(n))$ (cf. (2.20)) for *smooth* complete intersections X .

In the most general case, where w_i 's are arbitrary, one has to take into consideration the *divisibility relations* between them. Csorba [23], following a remark of Weihrauch concerning the dependence of the coefficients $\mathbf{c}_{m-1-k}(n; \mathbf{w})$ of $pt(n; \mathbf{w})$ (cf. (7.5)) on the Bernoulli numbers, gave formulae for this general case, which reduce the computation of $\mathbf{c}_{m-1-k}(n; \mathbf{w})$'s to the solutions of finitely many systems of linear congruence equations with at most $m-1$ unknowns. (Similar formulae for $pt^+(n; \mathbf{w})$ were found independently by Vahlen [121].) To present them, let us first introduce some useful notations.

(i) For $1 \leq k \leq m-1$, $1 \leq l \leq k$ and an index-set $\{i_1, \dots, i_l\} \subset \{1, \dots, m\}$ of "length l " we set:

$$e(i_1, \dots, i_l) := \gcd(w_j | 1 \leq j \leq m, j \notin \{i_1, \dots, i_l\})$$

$$e^{(\varepsilon)}(i_1, \dots, i_l) := e(i_1, \dots, i_{\varepsilon-1}, i_{\varepsilon+1}, \dots, i_l), \forall \varepsilon, 1 \leq \varepsilon \leq l$$

$$\mu(l; i_1, \dots, i_l) := \left(\prod_{\varepsilon=1}^l e^{(\varepsilon)}(i_1, \dots, i_l) \right) (e(i_1, \dots, i_l))^{1-l}$$

$$T(k; i_1, \dots, i_l) := \{(t_1, \dots, t_l) | 1 \leq t_s \leq k, \forall s, 1 \leq s \leq l, \text{ and } \sum_{s=1}^l t_s = k\}$$

$$\Xi^{(\varepsilon)}(i_1, \dots, i_l) :=$$

$$\left\{ \xi_{i_1, \dots, i_l}^{(\varepsilon)} | 0 \leq \xi_{i_1, \dots, i_l}^{(\varepsilon)} < \frac{e(i_1, \dots, i_l)}{e^{(\varepsilon)}(i_1, \dots, i_l)} : \sum_{\varepsilon=1}^l w_{i_\varepsilon} \xi_{i_1, \dots, i_l}^{(\varepsilon)} \equiv n \pmod{e(i_1, \dots, i_l)} \right\}$$

Furthermore, we define $\mathbf{I}(l)$ as the set of the following index-sets:

$$\mathbf{I}(l) := \{(i_1, \dots, i_l) | 1 \leq i_s \leq m, \forall s, 1 \leq s \leq l \text{ and } i_1 < i_2 < \dots < i_l\}.$$

(We notice that $\#(T(k; i_1, \dots, i_l)) = \binom{k-1}{k-l}$,

$$\#(\Xi^{(\varepsilon)}(i_1, \dots, i_l)) = \frac{(e(i_1, \dots, i_l))^{l-1}}{\sum_{\varepsilon=1}^l e^{(\varepsilon)}(i_1, \dots, i_l)} \text{ and } \#(\mathbf{I}(l)) = \binom{m}{l}.)$$

(ii) The *Bernoulli numbers* are defined by the series

$$\frac{x}{e^x - 1} = 1 - \frac{x}{2} + \frac{\mathbf{B}_1 x^2}{2!} - \frac{\mathbf{B}_2 x^4}{4!} + \frac{\mathbf{B}_3 x^6}{6!} - \dots$$

and are easily computable, as we have $\mathbf{B}_1 = \frac{1}{6}$, $\mathbf{B}_2 = \frac{1}{30}$, $\mathbf{B}_3 = \frac{1}{42}$, $\mathbf{B}_4 = \frac{1}{30}$, $\mathbf{B}_5 = \frac{5}{66}$ and, in general, for $j \geq 1$:

$$\binom{2j+1}{2} 2^2 \mathbf{B}_1 - \binom{2j+1}{4} 2^4 \mathbf{B}_2 + \binom{2j+1}{6} 2^6 \mathbf{B}_3 - \dots + (-1)^{j-1} (2j+1) 2^{2j} \mathbf{B}_j = 2j.$$

(iii) For $1 \leq k \leq m-1$, $1 \leq l \leq k$, a fixed index-set $(i_1, \dots, i_l) \in \mathbf{I}(l)$, and $(t_{i_1}, \dots, t_{i_l}) \in T(k; i_1, \dots, i_l)$, $\xi_{i_1, \dots, i_l}^{(\varepsilon)} \in \Xi(i_1, \dots, i_l)$, we define the function:

$$f_{t_{i_\varepsilon}}(\xi_{i_1, \dots, i_l}^{(\varepsilon)}) := \sum_{v=0}^{t_{i_\varepsilon}} \mathbf{G}_v \binom{t_{i_\varepsilon}}{v} \left(\frac{e(i_1, \dots, i_l)}{e^{(\varepsilon)}(i_1, \dots, i_l)} \right)^v (\xi_{i_1, \dots, i_l}^{(\varepsilon)})^{t_{i_\varepsilon} - v}$$

where

$$\mathbf{G}_0 := 1, \mathbf{G}_1 := -\frac{1}{2}, \mathbf{G}_v := \begin{cases} 0, & \text{if } v = 2\nu + 1, \nu > 0 \\ (-1)^{\nu-1} \mathbf{B}_{2\nu-1}, & \text{if } v = 2\nu, \nu > 0 \end{cases}$$

Theorem 7.5. (Formulae of Csorba (1914))

The coefficients $\mathbf{c}_{m-1-k}(n; \mathbf{w})$ of $pt(n; \mathbf{w})$ in (7.5), for $k > 0$, are given by the following formulae:

$$(7.10) \quad \mathbf{c}_{m-1-k}(n; \mathbf{w}) = \frac{(-1)^k}{(m-1-k)! \prod_{\nu=1}^m w_\nu} \sum_{l=1}^k \sum_{(i_1, \dots, i_l) \in \mathbf{I}(l)} \mu(l; i_1, \dots, i_l) \sum_{\substack{\xi_{i_1, \dots, i_l}^{(\varepsilon)} \\ \in \Xi(i_1, \dots, i_l)}} \dots \dots \dots \sum_{(t_{i_1}, \dots, t_{i_l}) \in T(k; i_1, \dots, i_l)} \prod_{\varepsilon=1}^l \frac{w_{i_\varepsilon}}{t_{i_\varepsilon}!} f_{t_{i_\varepsilon}}(\xi_{i_1, \dots, i_l}^{(\varepsilon)})$$

In the following years, Israilov [66] was eventually the only one who carried on the tradition of ‘‘Cayley-Sylvester era’’. Combining the expansion of $\mathbf{F}(x)$ into partial fractions with Mobius inversion law, he derived a ‘‘mammoth algorithmic formula’’ consisting of subroutine summations, which reduces the computation of $pt(n; \mathbf{w})$ to the determination of elements of certain PT’s corresponding to the Eulerian case. To write it down in a ‘‘compact form’’, let us introduce some special extra notations.

(i) For $1 \leq l \leq m$ and an index-set $\{j_1, \dots, j_l\} \subset \{1, \dots, m\}$ let $e(j_1, \dots, j_l)$ denote again

$$e(j_1, \dots, j_l) := \gcd(w_i | 1 \leq i \leq m, i \notin \{j_1, \dots, j_l\}).$$

For $1 \leq i \leq m$, $1 \leq \nu \leq m$, we define successively:

$$R_1^{(i)} := \{\{1, e(j_1)\} | 1 \leq j_1 \leq m, j_1 \neq i\}$$

$$R_2^{(i)} := R_1^{(i)} \cup \{e(j_1, j_2) | 1 \leq j_1 < j_2 \leq m, i \notin \{j_1, j_2\}\}$$

.....

$$R_\nu^{(i)} := R_{\nu-1}^{(i)} \cup \{e(j_1, \dots, j_\nu) | 1 \leq j_1 < j_2 < \dots < j_\nu \leq m, i \notin \{j_1, \dots, j_\nu\}\}$$

$$\text{and } \mathbf{R}_\nu := \bigcup_{i=1}^m R_\nu^{(i)}.$$

(ii) For $1 \leq i \leq m$, $\nu \in \mathbb{N}$, $k \in \mathbb{N}_0$, $\{j_1, \dots, j_l\} \subset \{1, \dots, m\}$, and $s(j_1, \dots, j_l)$ a divisor of $e(j_1, \dots, j_l)$, we define:

$$V(\nu; i; k; s(j_1, \dots, j_l)) := \begin{cases} \frac{1}{k+1} w_i^{[k+1]}, & \text{if } i \notin \{j_1, \dots, j_l\} \\ 1 - \zeta_{s(j_1, \dots, j_l)}^{-\nu w_i}, & \text{if } k = 0 \text{ and } i \in \{j_1, \dots, j_l\} \\ -w_i^{[k]} \zeta_{s(j_1, \dots, j_l)}^{-\nu w_i}, & \text{if } k > 0 \text{ and } i \in \{j_1, \dots, j_l\} \end{cases}$$

$$U(t; \nu; s(j_1, \dots, j_l)) := \sum_{\substack{0 \leq k_1, \dots, k_m \leq t \\ k_1 + \dots + k_m = t}} \frac{t!}{k_1! \dots k_m!} \left(\prod_{q=1}^m V(\nu; q; k_q; s(j_1, \dots, j_l)) \right)$$

and for $1 \leq p \leq m - 1$,

$$\Gamma(p; \nu; s(j_1, \dots, j_l)) := (-1)^{p-1} \sum \frac{(-1)^r r!}{r_1! \dots r_{p-1}!} \left(\prod_{i=1}^m V(\nu; i; 0; s(j_1, \dots, j_l)) \right)^{-1} \left(\prod_{t=1}^{p-1} \left(\frac{U(t; \nu; s(j_1, \dots, j_l))}{t!} \right)^{r_t} \right),$$

where the summation runs over all $(r_1, \dots, r_{p-1}) \in \text{PT}(p-1; 1, 2, \dots, p-1)$ and $r := r_1 + \dots + r_{p-1}$.

(iii) Correspondingly, for $1 \leq i \leq m$, $1 \leq t \leq i - 1$, we set:

$$Y(t) := \sum_{\substack{0 \leq \rho_1, \dots, \rho_m \leq t \\ \rho_1 + \dots + \rho_m = t}} \frac{t!}{(\rho_1 + 1)! \dots (\rho_m + 1)!} w_1^{[\rho_1+1]} \dots w_m^{[\rho_m+1]}, \quad \text{and}$$

$$A_i := (-1)^{i-1} \sum \frac{(-1)^r r!}{(w_1 \dots w_m)^{r+1}} \left(\prod_{t=1}^{i-1} \frac{1}{r_t!} \left(\frac{Y(t)}{t!} \right)^{r_t} \right),$$

where the sum runs again over all $(r_1, \dots, r_{i-1}) \in \text{PT}(i-1; 1, 2, \dots, i-1)$ and $r := r_1 + \dots + r_{i-1}$.

Theorem 7.6. (Formulae of Israilov (1981))

(i) If the weights w_1, \dots, w_m are pairwise coprime, then we have:

(7.11)

$$pt(n; \mathbf{w}) = \sum_{i=1}^m \left\{ A_i \frac{(n+m-i)^{[m-i]}}{(m-i)!} + \sum_{\mu=1}^{w_i-1} \zeta_{w_i}^{\mu n} w_i^{-1} \left(\prod_{\substack{j=1 \\ j \neq i}}^m (1 - \zeta_{w_i}^{-\mu w_j}) \right)^{-1} \right\}$$

(ii) In the general case (in which we may assume that \mathbf{w} is reduced), the number of the weighted partitions of n is given by the formula:

(7.12)

$$\begin{aligned} pt(n; \mathbf{w}) &= \sum_{i=1}^m A_i \frac{(n+m-i)^{[m-i]}}{(m-i)!} + \\ &+ \sum_{j=1}^m \sum_{\nu_j=1}^{e(j)-1} \sum_{p=1}^{m-1} \Gamma(p; \nu_j; e(j)) \frac{(n+m-p-1)^{[m-p-1]}}{(m-p-1)!} \zeta_{e(j)}^{\nu_j n} + \\ &+ \sum_{l=2}^{m-2} \sum_{1 \leq j_1 < \dots < j_l \leq m} \dots \\ &\dots \sum_{(1)} \sum_{(2)} \sum_{p=1}^{m-l} \Gamma(p; \nu; e(s_{j_1}, \dots, s_{j_l})) \frac{(n+m-l-p)^{[m-l-p]}}{(m-l-p)!} \zeta_{s(j_1, \dots, j_l)}^{\nu n} + \\ &+ \sum_{i=1}^m \sum_{(3)} \sum_{(4)} \zeta_{s(i)}^{\sigma_i n} w_i^{-1} \left(\prod_{\substack{\alpha=1 \\ \alpha \neq i}}^m (1 - \zeta_{s(i)}^{-\sigma_\alpha w_\alpha}) \right)^{-1} \end{aligned}$$

By $\sum_{(1)}$ we mean the sum running over all divisors (j_1, \dots, j_l) of $e(j_1, \dots, j_l)$ with $s(j_1, \dots, j_l) \nmid \mathbf{R}_{l-1}$. $\sum_{(2)}$ denotes the sum of all $1 \leq \nu \leq s(j_1, \dots, j_l)$, for which $\gcd(\nu, s(j_1, \dots, j_l)) = 1$. $\sum_{(3)}$ denotes the sum of all divisors $s(i)$ of the weight w_i with $s(i) \nmid R_{m-2}^{(i)}$. Finally, by $\sum_{(4)}$ is meant the summation over all indices $1 \leq \sigma_i \leq s(i)$, for which $\gcd(\sigma_i, s(i)) = 1$.

Remarks 7.7. (i) As the right hand sides of the formulae of theorems 7.4 and 7.6. contain trigonometric and transcendental functions in their periodic parts, the computation of the denumerants has to be made by using suitable approximation procedures. Sometimes it is enough to consider the "nearest integer function" or other standard inequalities, but in general the minimization of possible errors demands more sophisticated arithmetical methods. For some simple concrete examples see [20, pp. 109-115], [34], [38], [66, pp. 268-272], [111, p. 211] and [100,

pp. 117 -123].

(ii) For the Eulerian case, Gupta [57] gave the following denumerant bounds:

$$(7.13) \quad \frac{1}{m!} \binom{n-1}{m-1} \leq pt(n; 1, 2, \dots, m) \leq \frac{1}{m!} \binom{n + \frac{1}{2}m(m-1)}{m-1}$$

For the general case, Lambe [81] derived the upper bound:

$$(7.14) \quad pt(n; \mathbf{w}) \leq \binom{n + u(m; \mathbf{w})}{m-1} \gcd(w_1, \dots, w_m) \prod_{i=1}^m \frac{1}{w_i},$$

$$u(m; \mathbf{w}) := m + \frac{w_1 w_2}{\gcd(w_1, w_2)} - 2 + \sum_{i=3}^m \left[\frac{w_i \cdot \gcd(w_1, \dots, w_{i-1})}{2 \gcd(w_1, \dots, w_i)} \right],$$

where $[\cdot]$ denotes here the truncation to the nearest integer. (Note that $u(m; \mathbf{w})$ depends on the enumeration of the weights and that the above bound makes strange “jumps”.)

Remark 7.8. Lee proved in [82] that, in fact, PT’s are enough to describe completely the power series expansion of any rational function in one variable. For related topics see Stanley [111, Ch. 4].

Remark 7.9. Another reason which made the occupation with pt -functions very popular, not only among the mathematicians but also among the bank clerks and cashiers, was that these functions gave the answer to the *money changing problem*. (See Wilf [125, p. 87]). $pt(n; \mathbf{w})$ represents namely the number of the ways one can change an amount of money, say n , into coins or banknotes of denominations w_1, \dots, w_m . An indicative example is that one given by Luckey [84] in 1933, who defends the introduction of the “4-Pfennig” coin (100 Pfennig = 1 german Mark) by using the argument that, for instance, 30 Pfennig can be changed in $pt(30; 1, 2, 4, 5, 10) = 285$ ways, if one makes use of the “4-Pfennig” coin, and in only $pt(30; 1, 2, 5, 10) = 98$ ways if not.

Let us now proceed to the interpretation (b) of pt ’s, which was mentioned at the beginning of this section. By 1875 Weihrauch had already pointed out [123, pp. 99-100] that the enumeration of non-negative solutions of linear diophantine equations can be made “auf geometrischem Wege”. During the period 1955-1975 Ehrhart ([34], [35], [36], [37], [38]) developed a whole theory dealing with polyhedral enumerators.

Let $\mathbf{P} \subset \mathbb{R}^m$ be a q -dimensional rational polyhedron. (By a polyhedron we mean, as before, a *bounded convex* polyhedron, i.e. a *convex polytope*, which can always be represented as the convex hull of finitely many points.) We define:

$$E(n; \mathbf{P}) := \#(\mathbb{Z}^m \cap n\mathbf{P}), \quad E^+(n; \mathbf{P}) := \#(\mathbb{Z}^m \cap \text{int}(n\mathbf{P}))$$

and the *Ehrhart series*:

$$E_{\mathbf{P}}(x) := \sum_{n=0}^{\infty} E(n; \mathbf{P})x^n, \quad \text{with } E(0; \mathbf{P}) = 1, \quad \text{and}$$

$$E_{\mathbf{P}}^+(x) := \sum_{n=0}^{\infty} E^+(n; \mathbf{P})x^n, \quad \text{with } E^+(0; \mathbf{P}) = 0, \quad \text{respectively.}$$

Theorem 7.10. (Ehrhart (1967)) *If $q > 0$, then:*

(i) $E_{\mathbf{P}}(x)$ is a rational function and there is a quasipolynomial f of degree q with

$$E(n; \mathbf{P}) = f(n), \quad \text{for all } n \in \mathbb{N}_0.$$

(ii) It is $E^+(n; \mathbf{P}) = (-1)^q E(-n; \mathbf{P})$, for all $n \in \mathbb{N}$, where $E(-n; \mathbf{P}) := f(-n)$, and $E_{\mathbf{P}}^+(x) = (-1)^{q+1} E_{\mathbf{P}}(x^{-1})$.

Remarks 7.11. (i) f is called the *Ehrhart quasipolynomial* of \mathbf{P} . In particular, if \mathbf{P} is an *integral* polyhedron (i.e. if all the coordinates of its vertices are integers), then f has *constant* (rational) coefficients and we call it the *Ehrhart polynomial* of \mathbf{P} .

(ii) In the notation of (7.1) and (7.2) we have obviously $q = m - 1$, $pt(n; \mathbf{w}) = E(n; \Pi(\mathbf{w}))$ and $pt^+(n; \mathbf{w}) = E^+(n; \Pi(\mathbf{w}))$, $\forall n \in \mathbb{N}_0$, while $\tilde{pt}(n; w) = E(n; \Pi(\mathbf{w}))$, $\forall n \in \mathbb{Z}$ (cf. (7.4)).

Ehrhart's work was extended to various directions by Macdonald [85], Stanley (see [110], [111] and the other references given therein), Frumkin [43] and Betke-McMullen [11]. They did not only consider quasipolynomials arising from arbitrary systems of linear diophantine equations, but they also made use of techniques which allow a precise study of the properties of general $E(n; \mathbf{P})$'s. (See also rem. 7.14 (ii).)

Especially Stanley connected $E(n, \mathbf{P})$'s with "magic labelings" of certain graphs and with a whole "corpus" of interesting invariants appearing in the abstract commutative algebra.

Even more recently, and parallel to algorithmic investigations of the counting of integer points in polyhedra, like those of Dyer [33], Cook et al. [21], Bárány et al. [4] and Barvinok [6], combinatorialists and algebraic geometers attempted to find expressions for the coefficients \mathbf{a}_j of the Ehrhart polynomials

$$(7.15) \quad E(n; \mathbf{P}) = 1 + \mathbf{a}_1(\mathbf{P})n + \mathbf{a}_2(\mathbf{P})n^2 + \dots + \mathbf{a}_{q-1}(\mathbf{P})n^{q-1} + \mathbf{a}_q(\mathbf{P})n^q$$

of a q -dimensional *integral* polyhedron \mathbf{P} in terms of the geometry of \mathbf{P} by means of the theory of toric varieties.

It is well-known (see [25, § 5.8]) that one can associate every integral polyhedron \mathbf{P} in a q -dimensional lattice M with a complete toric variety $Z(N, \Sigma_{\mathbf{P}})$ (w.r.t. to its dual lattice N) by defining the corresponding fan $\Sigma_{\mathbf{P}}$ as follows: If F is a face of \mathbf{P} , let σ_F in M denote the cone consisting of all vectors $\lambda \cdot (x - x')$, where λ is a

nonnegative rational number, $x \in \mathbf{P}$ and $x' \in F$. Then (in the notation of § 3) we set $\Sigma_{\mathbf{P}} := \{\check{\sigma}_F | F \text{ is a face of } \mathbf{P}\}$.

Applying Hirzebruch's version of Riemann-Roch theorem [63, p. 155], [46, p. 288], to the line bundle $\mathcal{O}_{Z(N, \Sigma_{\mathbf{P}})}(D)$ of a T_N -Cartier divisor D being generated by its sections [47, p. 110], we get:

$$(7.16) \quad \chi(Z(N, \Sigma_{\mathbf{P}}), \mathcal{O}_{Z(N, \Sigma_{\mathbf{P}})}(nD)) = E(n; \mathbf{P})$$

and consequently

$$(7.17) \quad \mathbf{a}_j(\mathbf{P}) = \frac{1}{j!} \deg(D^j \frown \text{Td}_j(Z(N, \Sigma_{\mathbf{P}})))$$

where $\text{Td}(Z(N, \Sigma_{\mathbf{P}}))$ denotes the homology Todd class of $Z(N, \Sigma_{\mathbf{P}})$.

In fact, (7.17) is enough to show that $\mathbf{a}_j(\mathbf{P})$ is nothing but a linear combination of the volumes of the intersection of \mathbf{P} with the corresponding translations of the subspaces which are perpendicular to the j -codimensional cones of $\Sigma_{\mathbf{P}}$ ([25, pp. 134-135], [47, pp. 112-113]). Therefore, what one needs, is a geometric characterization of the rational (not always uniquely defined) coefficients of this linear combination.

The last two coefficients of $E(n; \mathbf{P})$ are actually easily computable, because by the classical Pick's theorem [96] (1899) we get:

- (i) $\mathbf{a}_q(\mathbf{P}) = \text{Vol}(\mathbf{P})$,
- (ii) $\mathbf{a}_{q-1}(\mathbf{P})$ equals half the sum of volumes of the $(q-1)$ -dimensional faces (By the volume of a j -dimensional face of \mathbf{P} is meant the relative volume w.r.t. the j -dimensional lattice in the j -plane containing it.)

For $q \geq 3$, however, the description of $\mathbf{a}_1(\mathbf{P}), \dots, \mathbf{a}_{q-2}(\mathbf{P})$ by means of the "local geometry" of $\Sigma_{\mathbf{P}}$ (resp. of \mathbf{P}) turned out to be much more complicated. (Even for $q = 3$, $\mathbf{a}_1(\mathbf{P})$ cannot be given by only using the 1-dimensional faces of \mathbf{P} .) The determination of these remaining coefficients of $E(n; \mathbf{P})$ became possible only after the proof of "finer" versions of *combinatorial Riemann-Roch theorem* and after further analysis of the corresponding Todd classes, due to Brion [14], Khovanskii-Pukhlikov [71] [72], Pommersheim [97], Kantor-Khovanskii [69], Morelli [89] and Capell-Shaneson [16]. For $q = 3$, Pommersheim derived a formula for $\mathbf{a}_1(\mathbf{P})$ in terms of the lattice volumes of 1- and 2-dimensional faces of \mathbf{P} and of functions depending on certain Dedekind sums. He generalized in this way a beautiful formula due to Mordell [88] (1951). Kantor and Khovanskii discussed the 4-dimensional case. For another approach to the most general case, see Morelli [89, p. 208].

Completing this appendix, we shall recall the formulae of Capell and Shaneson [16] as they lead to concrete computations and they connect, in a certain sense, Sylvester's "waves" with the "RR-arithmetics". The latter was originally introduced by Hirzebruch in his "Grundlehren"-monograph [63, ch. I, § 1, and ch. II, § 9] and involved many useful properties of hyperbolic tangent and cotangent functions relating the Todd classes with the L -classes. Some extra notations will be again unavoidable.

Let \mathbf{P} be a q -simplex with vertices in $M \cong \mathbb{Z}^q$ and N be the dual lattice of M . For each face R of \mathbf{P} we set: $\mathcal{F}_R := \{\text{faces of } \mathbf{P} \text{ of codimension one containing } R\}$ and $\mathcal{H}_R := \mathcal{F}_\emptyset \setminus \mathcal{F}_R$. For a simplicial q -dimensional cone σ in N , generated by n_1, \dots, n_q , let n'_1, \dots, n'_q be the unique primitive elements of N with $n'_i \cdot n_j = 0$ for $i \neq j$, and $\xi_i := n'_i \cdot n_i > 0$, $N' := \sum_{i=1}^q \mathbb{Z}n'_i$, $G_\sigma := N/N'$. Furthermore, for a $g = n_0 + N'$, let $\lambda_{n_j}(g)$ be the number

$$\lambda_{n_j}(g) := \exp(2\pi \sqrt{-1} \gamma_{n_j}(g)),$$

where $\gamma_{n_j}(g) := \frac{n_0 \cdot n_j}{\xi_j}$, and

$$G_\sigma^0 := \{g \in G_\sigma \mid \lambda_{n_j}(g) \neq 1, \forall j, 1 \leq j \leq q\}$$

(G_σ^0 consists of the elements of G_σ having the form $n_0 + N'$ with n_0 lying in the interior of the cone spanned by n'_1, \dots, n'_q .)

Keeping now these notations, as well as their “relative” analogues for all the cones of $\Sigma_{\mathbf{P}}$, in mind, we have:

Theorem 7.12. (*Formulae of Capell and Shaneson (1994)*).

Let \mathbf{P} be a q -simplex with vertices in the lattice M . For $0 \leq j \leq q$ let \mathbf{r}_j denote the coefficient of x^j in the power series

$$\sum_{R \prec \mathbf{P}} \frac{1}{|G_{\partial R}^0|} \left\{ \sum_{F \prec R} \mathbf{y}(F) \prod_{H \in \mathcal{H}_F} \frac{(\text{Vol}(H)x)}{\tanh(\text{Vol}(H)x)} \right\} \sum_{g \in G_{\partial R}^0} \mathbf{t}(R; g),$$

where $\mathbf{y}(F) := |G_{\partial F}^0| \cdot \prod_{H \in \mathcal{F}_F} (\text{Vol}(H)x)$ and

$$\mathbf{t}(R; g) := \prod_{H \in \mathcal{F}_R} \coth\{\pi \sqrt{-1} \gamma_H^R(g) + \text{Vol}(H)x\}.$$

(γ_H^R 's are “measured” again via the sublattices corresponding to H 's.) Furthermore, for any $R \prec \mathbf{P}$ with $\dim(R) = j$, let

$$\mathbf{s}_j := \frac{\text{Vol}(R)}{2^{q-j} |G_{\partial R}^0| \cdot \prod_{H \in \mathcal{F}_R} \text{Vol}(H)}.$$

Then the Ehrhart polynomial of \mathbf{P} is given by

$$(7.18) \quad E(n; \mathbf{P}) = \sum_{j=0}^q \mathbf{r}_j \mathbf{s}_j n^j.$$

Applications 7.13. The formulae of Capell and Shaneson can be applied for special n 's in our specific cases. Let $\mathbf{w} := (w_1, \dots, w_m)$ be a system of weights.

(i) If $\text{lcm}(w_1, \dots, w_m) \mid n$, i.e. if $n = k \cdot \text{lcm}(w_1, \dots, w_m)$ for some $k \in \mathbb{N}$, then

$$(7.19) \quad pt(n; \mathbf{w}) = E(k; \mathbf{P}'(\mathbf{w})),$$

where $\mathbf{P}'(\mathbf{w}) := \{(x_1, \dots, x_m) \in \mathbb{R}_{\geq 0}^m \mid \sum_{i=1}^m w_i x_i = \text{lcm}(w_1, \dots, w_m)\}$ with vertices $(\frac{1}{w_1} \text{lcm}(w_1, \dots, w_m), 0, \dots, 0), \dots, (0, \dots, 0, \frac{1}{w_m} \text{lcm}(w_1, \dots, w_m))$.

(ii) For an $n \in \mathbb{N}$, let $\tilde{n} := n + \sum_{i=1}^m w_i$. If $\text{lcm}(w_1, \dots, w_m) \mid \tilde{n}$, i.e. if $\tilde{n} = \lambda \cdot \text{lcm}(w_1, \dots, w_m)$ for some $\lambda \in \mathbb{N}$, and if for a weight, say w_m , we have $w_m = 1$, then:

(7.20)

$$pt(n; \mathbf{w}) = pt^+(\tilde{n}; \mathbf{w}) = E^+(\tilde{n}; \Pi(w_1, \dots, w_{m-1}, 1)) = E^+(\lambda; \tilde{\mathbf{P}}(w_1, \dots, w_{m-1})),$$

where $\tilde{\mathbf{P}}(w_1, \dots, w_{m-1})$ denotes the convex hull of the points $(0, \dots, 0)$, $(\frac{1}{w_1} \text{lcm}(w_1, \dots, w_{m-1}), 0, \dots, 0), \dots, (0, \dots, 0, \frac{1}{w_{m-1}} \text{lcm}(w_1, \dots, w_{m-1}))$. Thus, $pt(n; \mathbf{w})$ can be found by the reciprocity law of theorem 7.10. (ii) and the formula (7.18) of Capell and Shaneson.

(iii) If $X = X_d \subset \mathbb{P}^{m-1}(\mathbf{w})$ is a well-formed *BP-like* (cf. 2.16.) quasismooth hypersurface, then (2.20) gives:

$$(7.21) \quad h^0(X, \mathcal{O}_X(\text{am}(X))) = pt(d - \sum_{i=1}^m w_i; \mathbf{w}) = pt^+(d; \mathbf{w})$$

If one of the weights happens to be 1, (7.21) can be computed by (7.20).

(iv) In the special case in which $m = 4$, $w_4 = 1$, $\text{gcd}(w_1, w_2, w_3) = 1$, $\tilde{n} := n + w_1 + w_2 + w_3$ and $\tilde{n} = \lambda \cdot \text{lcm}(w_1, w_2, w_3)$ for some $\lambda \in \mathbb{N}$, one obtains (7.20) via Pommersheim's formula for the tetrahedron $\tilde{\mathbf{P}}(w_1, w_2, w_3)$ ([97, thm. 5, p. 17]) after having subtracted the lattice points on its faces. The result is the following:

(7.22)

$$\begin{aligned} pt(n; w_1, w_2, w_3, 1) &= E^+(\lambda; \tilde{\mathbf{P}}(w_1, w_2, w_3)) = \\ &= \frac{1}{6}(w_1^2 w_2^2 w_3^2 T^3) \lambda^3 - \frac{1}{4}[w_1 w_2 w_3 (w_1 + w_2 + w_3 + 1) T^2] \lambda^2 + \\ &+ \left\{ \frac{1}{12}(w_1^2 + w_2^2 + w_3^2 + 1) T + \frac{1}{4}[(w_1 w_2 + w_2 w_3 + w_3 w_1) T + w_1^* + w_2^* + w_3^*] \right. \\ &- w_1^* \cdot \text{DS}(w_1, \text{gcd}(w_2, w_3)) - w_2^* \cdot \text{DS}(w_2, \text{gcd}(w_1, w_3)) \\ &\left. - w_3^* \cdot \text{DS}(w_3, \text{gcd}(w_1, w_2)) \right\} \lambda - 1 \end{aligned}$$

In (7.22) we use the abbreviations:

$$T := \left(\prod_{i < j} \text{gcd}(w_i, w_j) \right)^{-1}, \quad w_i^* := w_i \left(\prod_{j \neq i} \text{gcd}(w_i, w_j) \right)^{-1}, \quad \forall i, \quad 1 \leq i \leq 3.$$

Moreover, by $\text{DS}(\mu, \nu)$ we denote the *Dedekind sum* of two coprime integers μ and ν being defined by

$$(7.23) \quad \text{DS}(\mu, \nu) := \sum_{i=1}^{\nu-1} \left(\binom{i}{\nu} \right) \left(\binom{\mu i}{\nu} \right)$$

where for an $x \in \mathbb{Q}$:

$$((x)) := \begin{cases} x - [x] - \frac{1}{2}, & x \notin \mathbb{Z} \\ 0, & x \in \mathbb{Z} \end{cases}$$

and $[x]$ is the greatest integer $\leq x$.

(v) Formulae similar to (7.22), when $m = 5$, can be derived by the results of Kantor and Khovanskii [69].

Additional remarks 7.14. (i) For those who are interested in *numerical applications*, we would recommend a very useful MAPLE package for the computation of denumerants of weighted partitions, which has been recently implemented by P. Lisoněk (“Quasi-polynomials: a case study in experimental combinatorics”, RISC-report, 93-18, 1993) and relies on formulae being presented in Comtet’s book [20, § 2.6].

(ii) After having written this section, we received a new preprint of Prof. B. Sturmfels (“On vector partition functions”, Cornell University, 1994) which deals with *vectorial denumerants* $\text{pt}(\mathbf{n}; A)$ defined by

$$\prod_{i=1}^m \frac{1}{(1 - x_1^{w_{1,i}} x_2^{w_{2,i}} \dots x_\mu^{w_{\mu,i}})} = \sum_{\mathbf{n} \in \mathbb{N}_0^\mu} \text{pt}(\mathbf{n}; A) x_1^{n_1} x_2^{n_2} \dots x_\mu^{n_\mu}$$

and expressing the number of non-negative integer vectors $(\lambda_1, \dots, \lambda_m) \in \mathbb{N}_0^m$, which are solutions of the system $A \cdot (\lambda_1, \dots, \lambda_m)^T = \lambda_1 \mathbf{w}_1 + \dots + \lambda_m \mathbf{w}_m = \mathbf{n} = (n_1, \dots, n_\mu)$ of μ linear diophantine equations with $A = (\mathbf{w}_1, \dots, \mathbf{w}_m)$, $\mathbf{w}_1 = (w_{1,1}, \dots, w_{\mu,1})^T, \dots, \mathbf{w}_m = (w_{1,m}, \dots, w_{\mu,m})^T$. His main result is a formula of type

$$\begin{aligned} \text{pt}(\mathbf{n}; A) = & \text{(a polynomial of degree } m - \mu \text{ in } \mathbf{n} = (n_1, \dots, n_\mu)) + \\ & + \text{(certain rational linear combinations of “corrector polynomials”),} \end{aligned}$$

where these corrector polynomials, as well as their corresponding rational coefficients, can be computed by means of the *chamber complex* of the cone $\mathbb{R}_{\geq 0} \mathbf{w}_1 + \dots + \mathbb{R}_{\geq 0} \mathbf{w}_m$ and of certain linear partial differential equations depending on it. Sturmfels formula provides therefore a generalization of the “usual” theory of denumerants (the $\mu = 1$ case) and gives an *explicit* geometrical-combinatorial interpretation of their higher dimensional analogues.



Acknowledgements.

The author would like to express his deep gratitude to Professor F. Hirzebruch for introducing him to the theory of CY manifolds, and for encouraging discussions and valuable assistance over all these years.

He owes thanks to Professors Yu.I. Manin and M. Kontsevich for a series of illuminating lectures on CY manifolds within the framework of “MPI-Quantum Fields and Mirror Symmetry seminar”, to Professors A. Dimca, I. Dolgachev, H.A. Hamm and K. Oguiso for stimulating conversations, to Prof. S.-S. Roan for useful remarks and suggestions, and is also indebted to Dr. Petridis for his helpful criticism during the arithmetical programming which was used in §6.

He wishes to make further acknowledgement for the long term collaboration with physicists Dr. A. Klemm and Dr. R. Schimmrigk who provided him the opportunity to learn certain string theoretical techniques and who helped him by many arithmetical checkings.

Last but not least, he is grateful to the library staff of the Mathematical Department of Bonn University and of Max-Planck-Institut für Mathematik, and especially to Mrs. B. Jakobs and Mrs. Ch. Pearce-Jahre who made available significant references which enabled him to write the historical part of the appendix of the seventh section, as well as to Mrs. M. Sarlette for setting the manuscript into TEX.

Finally, he dedicates this thesis to Mina Dais, and to the memory of Dimitrios Fidas and Ioannis Dais, in deep appreciation for their moral support of his work.

REFERENCES

- [1] Aleksandrov A.G., *The de Rham complex of a quasismooth complete intersection*, *Funct. Anal. and its Appl.* Vol. 17, No 1 (1981), 48-49.
- [2] Aleksandrov A.G., *Cohomology of quasihomogeneous complete intersections*, *Math. USSR Izvestija* Vol. 26, No 3 (1986), 437-477.
- [3] Andrews G.E., *Partitions*, *Encyclopedia of Mathematics* Vol. 2 (1976), Cambridge University Press.
- [4] Bárány I., Howe R., Lovász L., *On integer points in polyhedra: a lower bound*, *Combinatorica* 12 (1992), 135-142.
- [5] Barth W., Peters C., Van de Ven A., *Compact complex surfaces*, *Ergebnisse der Mathematik und ihrer Grenzgebiete* 3. Folge, Bd. 4 (1984), Springer-Verlag.
- [6] Barvinok A.I., *Counting the volume, counting integral points and exponential sums*, *Discrete and Computational Geometry* 10 (1993), 123-141.
- [7] Batyrev V.V., *Dual polyhedra and the mirror symmetry for Calabi-Yau hypersurfaces in toric varieties*, *Jour. of Alg. Geometry* Vol. 3, No. 3 (1994) 493-535.
- [8] Beauville A., *Variétés Kähleriennes dont la première classe de Chern est nulle*, *Jour. Diff. Geom.* 18 (1983), 755-782.
- [9] Beauville A., *Some remarks on Kähler manifolds with $c_1 = 0$* , In: *Classification of algebraic and analytic manifolds*, (Katata Symposium Proc., ed. K. Ueno), *Progress in Mathematics* Vol. 39 (1983), Birkhäuser, 1-26.
- [10] Beltrametti M., Robbiano L., *Introduction to the theory of weighted projective spaces*, *Exp. Math* 4 (1986), 111-162.
- [11] Betke U., McMullen P., *Lattice points in lattice polytopes*, *Monatshefte für Mathematik* 99 (1985), 253-265.
- [12] Bogomolov F., *Hamiltonian Kähler manifolds*, *Soviet. Math. Dokl.* 19 (1978), 1462-1465.
- [13] Bredon G.E., *Sheaf Theory*, Mc-Graw-Hill Book company (1967).
- [14] Brion M., *Points entiers dans de polyèdre convexes*, *Ann. Sc. Éc. Norm. Sup.*, t. 21 (1988), 653-663.
- [15] Candelas P., Lynker M., Schimmrigk R., *Calabi-Yau manifolds in weighted \mathbb{P}^4* , *Nucl. Ph. B.* Vol. 341 (1990), 383-402.
- [16] Capell S.E., Shaneson J.L., *Genera of algebraic varieties and counting of lattice points*, *Bull. of the Amer. Math. Soc. (New Series)* Vol 30, No. 1 (1994), 62-69.
- [17] Cayley A., *Researches on the partition of the numbers*, *Phil. Trans.* Vol. 146 (1856), 101-126, and in "The collected mathematical papers of A. Cayley" Cambridge Univ. Press (1889) 235-249.
- [18] Chazelle B., *Triangulating a simple polygon in linear time*, *Discrete and Computational Geometry* Vol. 6 (1991), 485-524.
- [19] Clarkson K.L., Tarjan R.E., Van Wyk C.J., *A fast Las Vegas algorithm for triangulating a simple polygon*, *Discrete and Computational Geometry* Vol. 4 (1989), 423-432.
- [20] Comtet L., *Advanced Combinatorics* (1974), Reidel, Boston.
- [21] Cook W., Hartmann M., Kannan R., McDiarmid, *On integer points in polyhedra*, *Combinatorica* 12 (1992), 27-37.
- [22] Cox D.A., *Picard numbers of surfaces in 3-dimensional weighted projective spaces*, *Math. Z.* 201 (1989), 183-189.
- [23] Csorba G., *Über die Partitionen der ganzen Zahlen*, *Math. Annalen*, Bd. 75 (1914), 545-568.
- [24] Dais D.I., *On toroidal crepant desingularizations of 3-dimensional Calabi-Yau ABQ- and T-varieties*, in preparation.
- [25] Danilov V.I., *The geometry of toric varieties*, *Russian Math. Surveys* 33 (1978), 97-154.
- [26] Danilov V.I., *The birational geometry of toric 3-folds*, *Math. USSR-Izvestija* 21 (1983), 269-280.
- [27] Deligne P., *Théorème de Lefschetz et critères de dégénérescence de suites spectrales*, *Publ. Math. IHES* 35 (1968), 107-126.
- [28] Delorme Ch., *Espaces projectifs anisotropes*, *Bull. Soc. Math. France*, t. 103 (1975), 203-223.

- [29] Dickson L.E., *History of the theory of numbers*, Vol. II, Chelsea Pub. Co. (1920).
- [30] Dimca A., *Singularities and coverings of weighted complete intersections*, Jour. für die r. und. ang. Math., Bd. 366 (1986), 184-193.
- [31] Dimca A., Dimiev S., *On analytic coverings of weighted projective spaces*, Bull. London Math. Soc. 17 (1985), 234-238.
- [32] Dolgachev I., *Weighted projective varieties*, In: *Group actions and vector fields*, Proc. Polish-North Amer. Sem., Vancouver 1981, Lecture Notes in Math. Vol. 956 (1982), Springer Verlag, 34-71.
- [33] Dyer M., *On counting lattice points in polyedra*, Siam J. of Comp. Vol. 20, No. 4 (1991), 695-707.
- [34] Ehrhart E., *Sur un problème de partition d'un nombre*, C.R. Acad. Sc. Paris, t. 259 (1964), 2746-2747.
- [35] Ehrhart E., *Sur la partition des nombres*, C.R. Acad. Sc. Paris, t. 259 (1964), 3151-3153.
- [36] Ehrhart E., *Démonstration de la loi de réciprocité pour un polyèdre entier*, C.R. Acad. Sc. Paris, t. 265 (1967), A5-A7.
- [37] Ehrhart E., *Sur un problème de géométrie diophantienne linéaire I, II*, Jour. für die r. und ang. Math., Bd. 226 (1967) 1-29 and Bd. 227 (1967) 25-49.
- [38] Ehrhart E., *Polynômes arithmétiques et Méthodes des Polyèdres en Combinatoire*, International Series of Numerical Mathematics Vol. 35 (1977), Birkhäuser.
- [39] Erdős P., Lehner J., *The distribution of the numbers of summands in the partitions of a positive integer*, Duke Math. J. Vol. 8 (1941), 335-345.
- [40] Euler L., *Introductio in analysin infinitorum*, Ch. 16 (1748), 253-257.
- [41] Fletcher A.R., *Working with weighted complete intersections*, MPI-series, No. 35 (1989), Bonn.
- [42] Friedman R., *On threefolds with trivial canonical bundle*, Proc. Symp. in Pure Math., A.M.S. Vol. 53 (1991), 103-134.
- [43] Frumkin M.A., *Number of natural solutions of a system of linear diophantine equations*, Math. Notes of the Acad. of Sciences of the USSR Vol. 28, No 1-2 (1981), 627-634.
- [44] Fujita T., *Theorems of Bertini type for certain types of polarized manifolds*, Jour. Math. Soc. Japan 34 (1982), 709-718.
- [45] Fujita T., *Classification theories of polarized varieties*, London Math. Soc., Lecture Note Series 155 (1990), Cambridge University Press.
- [46] Fulton W., *Intersection theory*, Ergebnisse der Mathematik und ihrer Grenzgebiete, 3. Folge, Bd. 2 (1984), Springer-Verlag.
- [47] Fulton W., *Introduction to toric varieties* (1993), Princeton University Press.
- [48] Glaisher J.W.L., *Formulae for partitions into given elements, derived from Sylvester's theorem*, Quarterly Journal of Pure and Applied Mathematics 40 (1909), 275-348.
- [49] Green P., Hübsch T., *$(1, 1)^3$ -couplings in Calabi-Yau threefolds*, Classification and Quantum Gravity Vol. 6 (1989), 311-327.
- [50] Greuel G.-M., *Der Gauß-Manin Zusammenhang isolierter Singularitäten von vollständigen Durchschnitten*, Math. Annalen, Bd. 214 (1975), 235-266.
- [51] Greuel G.-M., *Dualität in der lokalen Kohomologie isolierter Singularitäten*, Math. Annalen, Bd. 250 (1980), 157-173.
- [52] Greuel G.-M., Hamm H.A., *Invarianten quasihomogener vollständiger Durchschnitte*, Invent. Math. 49 (1978), 67-86.
- [53] Grothendieck A. and Dieudonné J., *Éléments de géométrie algébrique (EGA II), Étude globale élémentaire de quelques classes de morphismes* Vol. 8 (1961), Publ. Math. IHES, 5-222.
- [54] Grothendieck A. and Dieudonné J., *Éléments de géométrie algébrique (EGA III), Étude cohomologique des faisceaux cohérents (Première Partie)*, Publ. Math. IHES Vol. 11 (1961), 349-511.
- [55] Grothendieck A., *Local cohomology*, Lecture Notes in Math. Vol. 41 (1967), Springer-Verlag.
- [56] Grothendieck A., *Cohomologie locale des faisceaux cohérents et théorèmes de Lefschetz locaux et globaux (SGA 2)*, North Holland (1968).

- [57] Gupta H., *On an asymptotic formula in partitions*, Proc. Indian Acad. Sc., A 16 (1942), 101-102.
- [58] Hamm H.A., *Lokale topologische Eigenschaften komplexer Räume*, Math. Annalen, Bd. 191 (1971), 235-252.
- [59] Hamm H.A., *The genus χ_ψ of quasihomogeneous complete intersections*, Funct. Anal. and its Appl. Vol. 11, No 7 (1977), 87-88.
- [60] Hamm H.A., *Invariants of weighted homogeneous singularities*, Journées Complexes Nancy (S.M.F.-C.N.R.S.), Institut Elie Cartan, No 10 (1986), 6-13.
- [61] Hartshorne R., *Algebraic Geometry*, G.T.M. Vol. 52 (1977), Springer-Verlag.
- [62] Herschel J., *On circulating functions, and on the integration of a class of equations of finite differences into which they enter as coefficients*, Phil. Trans. Roy. Soc. of London, 108 (1818), 144-168.
- [63] Hirzebruch F., *Topological methods in algebraic geometry*, Grundlehren der mathematischen Wissenschaften, Bd. 131, Second, corrected printing of the third edition (1978), Springer Verlag.
- [64] Hosono S., Klemm A., Theisen S., Yau S.-T., *Mirror symmetry: Mirror map and applications to Calabi-Yau hypersurfaces (resp. to complete intersection Calabi-Yau spaces)*, preprints HUTMP-93/0801 and HUTMP-94/02, to appear in Comm. Math. Physics.
- [65] Hübsch T., *Calabi-Yau Manifolds. A bestiary for physicists*, World Scientific (1992).
- [66] Israilov M.I., *Numbers of solutions of linear diophantine equations and their applications in the theory of invariant cubature formulae*, Siberian Math. Journ. 22 (1981), 260-273.
- [67] de Jong A.J., Steenbrink J.H.M., *Picard numbers of surfaces in 3-dimensional weighted projective spaces*, Math. Z. 206 (1991), 341-344.
- [68] Jupp P.E., *Classification of certain 6-manifolds*, Proc. Cambridge Phil. Soc. 73 (1973), 293-300.
- [69] Kantor J.M. Khovanskii A., *Une application du Théorème de Riemann-Roch combinatoire au polynôme d'Ehrhart des polyèdres entier de \mathbb{R}^d* , C.R. Acad. Sc. Paris, t. 317 (1993), 501-5-7.
- [70] Kawamata Y., Matsuki K., *The number of minimal models for a 3-fold of general type is finite*, Math. Annalen, Bd. 276 (1987), 595-598.
- [71] Khovanskii A., Pukhlikov S., *Mesures additives invariantes pour les polyèdres virtuels*, Algebra i Analiz 4 (1992), 161-185.
- [72] Khovanskii A., Pukhlikov S., *Théorème de Riemann-Roch pour les intégrales et les sommes de quasi-polynômes sur les polyèdres virtuels*, Algebra i Analiz 4 (1992), 188-216.
- [73] Klemm A., *Computer search programme for the determination of well-formed CY q.s.c. intersections of codimension 2 or 3*, CERN (1994).
- [74] Klemm A., Schimmrigk R., *Landau-Ginzburg string vacua*, CERN-TH 6459, preprint (1992) and Nucl. Ph. B. Vol. 411 (1994), 559-583.
- [75] Knop F., Kraft H., Vust T., *The Picard group of a G-variety.*, In: *Algebraic Transformation Groups and Invariant Theory*, DMV-Seminar, Bd. 13 (1989), Birkhäuser, 77-87.
- [76] Kollár J., *Vanishing theorems for cohomology groups*, In: *Algebraic Geometry, Bowdoin 1985*, Proc. of Symp. of Pure Math. Vol. 46 (1987), part I, A.M.S., 233-243.
- [77] Kollár J., *Flops*, Nagoya Math. Journal 113 (1989), 14-36.
- [78] Kollár J., *Flips, flops, minimal models etc.*, Surveys in Diff. Geometry 1 (1991), 113-199.
- [79] Kreuzer M., Skarke H., *No mirror symmetry in Landau-Ginzburg spectra*, CERN-TH 6461, preprint (1992), and Nucl. Phys. B 388 (1992) 113-130.
- [80] Laguerre E., *Sur la partition des nombres*, Bulletin de la Société mathématique de France, 5 (1876-7), 76-78.
- [81] Lambe Th.A., *Upper bound on the number of nonnegative integer solutions to a linear equation*, Siam Jour. Appl. Math. Vol. 32 (1977), No 1, 215-219.
- [82] Lee D.V., *On the power-series expansion of a rational function*, Acta Arithmetica 62 (1992), 229-255.
- [83] Lojasiewicz S., *Triangulations of semianalytic sets*, Analli della Scuola Normale Superiore di Pisa, Serie III Vol. 18 (1964), 449-474.

- [84] Luckey P., *Auf wieviel verschiedene Arten lässt sich ein Geldbetrag in kleine Münzen ohne und mit Benutzung des Vierpfennigstücks auszahlen ?*, Unterrichtsblätter für Mathematik und Naturwissenschaften, Bd. 39 (1933), 50-52.
- [85] Macdonald I.G., (a) *The volume of a lattice polyhedron*, Proc. Camb. Phil. Soc. 59 (1963), 719-726, (b) *Polynomials associated with finite cell-complexes*, J. London Math. Soc. (2), Vol. 4, 181-192, (1971).
- [86] Markushevich, D.G., *Resolution of singularities*, Appendix of the article: Markushevich D.G., Olshanetsky M.A., Perelomov A.M., *Description of a class of superstring compactifications related to semi-simple Lie algebras*, Comm. in Math. Phys. Vol. 111 (1987), 247-274.
- [87] Miyaoka Y., *The Chern classes and Kodaira dimension of a minimal variety*, Adv. Studies in Pure Math. 10 (1987), 449-476.
- [88] Mordell L.J., *Lattice points in a tetrahedron and generalized Dedekind sums*, J. Indian Math. 15 (1951), 41-46.
- [89] Morelli R., *Pick's theorem and the Todd class of a toric variety*, Adv. in Math. 100 (1993), 183-231.
- [90] Mori Sh., *On a generalization of complete intersections*, Jour. Math. Kyoto Univ. Vol. 15 (1975), 619-646, No 3.
- [91] Morrison D.R., *Mirror symmetry and rational curves on quintic threefolds: a guide for mathematicians*, Jour. of Amer. Math. Soc. 6 (1993), 223-247.
- [92] Netto E., *Lehrbuch der Combinatorik*, Teubner Verlag (1901), Sec. Ed. (with compl.) Chelsea Pub. Co. (1928).
- [93] Oda T., *Convex Bodies and Algebraic Geometry. An Introduction to the theory of toric varieties*, Ergebnisse der Mathematik und ihrer Grenzgebiete, 3. Folge, Bd. 15 (1988), Springer-Verlag.
- [94] Oguiso K., *On polarized Calabi-Yau threefolds*, Jour. Fac. Sci. Univ. Tokyo 38 (1991), 395-429.
- [95] Oguiso K., Peternell, T., *On polarized canonical Calabi-Yau threefolds* (1995), 237-248, Math. Annalen, Bd. 301.
- [96] Pick G., *Geometrisches zur Zahlenlehre*, Sitzungsber. Lotos Prag. (2) 19 (1899), 311-319.
- [97] Pommersheim J.E., *Toric varieties, lattice points and Dedekind sums*, Math. Annalen, Bd. 295 (1993), 1-24.
- [98] Reid M., *Canonical threefolds*, Journées de Géométrie Algébrique d'Angers, A. Beauville ed., Sijthoff and Noordhoff, Alphen aan den Rijn (1980), 273-310.
- [99] Reid M., *Minimal models of canonical 3-folds*, Adv. Studies in Pure Math. 1 (1983), 131-180.
- [100] Riordan J., *An introduction to combinatorial analysis*, Chapman and Hall (1968).
- [101] Roan S.S., (a) *On the generalization of Kummer surfaces*, Journal of Diff. Geom., Vol. 30, (1989), 523-537, (b) *On Calabi-Yau orbifolds in weighted projective spaces*, Int. Jour. of Math. Vol. 1 (1990), 211-232.
- [102] Roan S.S., (a) *The mirror of Calabi-Yau orbifolds*, Int. Jour. of Math. Vol. 2 (1991), 439-455, (b) *Topological properties of Calabi-Yau mirror manifolds*, preprint (1992), (c) *Toric geometry in mirror symmetry*, Institute of Math. Acad. Sinica, Preprint R940907-1, (1994).
- [103] Roan S.S., *Topological couplings of Calabi-Yau orbifolds*, Journal of Group Theory in Physics Vol. 1, No. 1 (1993), 83-103.
- [104] Robbiano L., *Factorial and almost factorial schemes in weighted projective spaces*, C.I.M.E., Lecture Notes in Math. Vol. 1092 (1984), Springer Verlag, 62-84.
- [105] Schimmrigk R., *Mirror Symmetry and string vacua from a special class of Fano varieties*, TH-007, Bonn, preprint (1994).
- [106] Schrijver A., *Theory of linear and integer programming*, Wiley (1990).
- [107] Shepherd-Barron N.I., Wilson P.M.H., *Singular threefolds with numerically trivial first and second Chern classes*, Jour. of Alg. Geom. 3 (1994), 265-281.
- [108] Shiffman B., Sommese A.J., *Vanishing theorems on complex manifolds*, Progress in Math. Vol. 56 (1985), Birkhäuser.
- [109] Serre J.-P., *A course in arithmetic*, GTM Vol. 7 (1973), Springer-Verlag.

- [109] Serre J.-P., *A course in arithmetic*, GTM Vol. 7 (1973), Springer-Verlag.
- [110] Stanley R., *Decompositions of rational convex polytopes*, Annals of Discrete Mathematics 6 (1980), 333-342.
- [111] Stanley R., *Enumerative Combinatorics*, Wadsworth and Brooks/Cole Mathematics Series Vol. I (1986).
- [112] Steenbrink J.H.M., *Mixed Hodge structures on the vanishing cohomology*, In: "Real and Complex Singularities", Proc. of the 9th summer school/NAVF Symp. Math., Oslo 1976, ed. P. Holm, Alphen aan den Rijn (1977), 525-563.
- [113] Steenbrink J.H.M., *On the Picard group of certain smooth surfaces in weighted projective spaces*, Lecture Notes in Math. Vol 961 (1981), Springer-Verlag, 302-313.
- [114] Sullivan D., *Infinitesimal computations in topology*, Publ. Math. IHES 47 (1987), 269-331.
- [115] Sylvester J.J., *On the partition of numbers*, The Quarterly Journal of Pure and Applied Mathematics (1857), 141-152.
- [116] Sylvester J.J., *On subinvariants, i.e. semi-invariants to binary quantics of an unlimited order*, Amer. Jour. Math. 5 (1882), 77-136.
- [117] Szekeres G., *Some asymptotic formulae in the theory of partitions I, II*, Quart. J. M. Oxford, 2 (1951) 85-108 and 4 (1953) 96-111.
- [118] Tian G., *Smoothness of the universal deformation space of compact Calabi-Yau manifolds and its Petersson-Weil metric*, In: *Mathematical aspects in string theory*, Ed. S.T.-Yau, World Scientific (1987), 629-646.
- [119] Todorov A.N., *The Weil-Petersson geometry of the moduli space of $SU(n)$, $n \geq 3$, Calabi-Yau manifolds I*, Comm. Math. Phys. 126 (1989), 325-346.
- [120] Vafa C., *String racua and orbifoldized LG-models*, Mod. Phys. Lett. A 4 (1989), 1169-1185.
- [121] Vahlen Th., *Zur Partition der Zahlen*, S.B. Akad. Berlin (1929), 394-400.
- [122] Wall C.T.C., *Classification problems in differential topology V. On certain 6-manifolds*, Invent. Math. 1 (1966), 355-374.
- [123] Weihrauch K., *Die Anzahl der Lösungen diophantischer Gleichungen bei theilfremden Coefficienten*, Zeitschrift für Mathematik und Physik, Bd. 20 (1875), 97-111.
- [124] Weihrauch K., *Anzahl der Lösungen für die allgemeinste Gleichung ersten Grades mit vier Unbekannten*, Zeitschrift für Mathematik und Physik, Bd. 22 (1877), 234-243.
- [125] Wilf H.S., *Generating Functionology*, Academic Press (1989).
- [126] Wilson P.M.H., *Calabi-Yau manifolds with large Picard number*, Invent. Math. 98 (1989), 139-155.
- [127] Wilson P.M.H., *The Kähler cone on Calabi-Yau threefolds*, Invent. Math. Vol. 107 (1992), 561-584, and Vol. 114 (1993) 231-233.
- [128] Wilson P.M.H., *Minimal models of Calabi-Yau threefolds*, In: Classification of Algebraic Varieties (ed. C. Ciliberto, E.L. Livorni, A.J. Sommese), AMS Contemporary Math. Vol. 162 (1994), 403-410.
- [129] Witten E., *Phases of $N = 2$ theories in two dimensions*, Nucl. Ph. B Vol. 403 (1993), 159-222.
- [130] Yau S.-T., *Calabi's conjecture and some new results in algebraic geometry*, Proc. Nat. Acad. Sci. USA 74 (1977), 1798-1799.
- [131] Yau S.-T. (ed.), *Essays on Mirror Manifolds*, International Press, Hong Kong (1992).
- [132] Žubr A.V., *Classification of simply connected 6-dimensional spinor manifolds*, Math. USSR Izvestija Vol. 9 (1975), 793-812, No 4.
- [133] Žubr A.V., *Classification of simply connected topological 6-manifolds*, Lecture Notes in Math. Vol. 1346 (1980), Springer Verlag, 325-340.

List of certain special Symbols

$\mathbb{N}, \mathbb{N}_0, \mathbb{Z}, \mathbb{Q}, \mathbb{R}_{\geq 0}, \mathbb{C}$	5	$S(\mathbf{w}), \mathbb{P}^{m-1}(\mathbf{w})$	12
gcd, lcm	5	$p(\mathbf{w}), \pi(\mathbf{w})$	12
$[m]_\ell, \binom{n}{k}, \zeta_n$	5	$\bar{\mathbf{w}}, \mathbf{w}'$	13
$ S , \sharp(S)$	5	$\mathbb{P}_I := \mathbb{P}_I(\mathbf{w}), c_I$	13
$\delta_S, \delta_{p,q}$	5	$\theta(n; \mathbf{w}), \gamma_i(n; \mathbf{w}), \epsilon_i(n; \mathbf{w})$	14
A, \mathfrak{M}	5	$\iota(\mathbf{w}), X^{\text{cov}}$	14
$H_{\mathfrak{M}}^q(M)$	5	$CN(X), CN^*(X)$	14
Proj(A)	5	$X_{\mathbf{d}}(I) := X_{\mathbf{d}} \cap \mathbb{P}_I$	19
$\mathcal{O}_X(n) := A(n)^\sim$	5	$\text{am}(X_{\mathbf{d}}) := \text{am}(\mathbf{w}, \mathbf{d})$	19
$M(n)^\sim, \tilde{M}(n)$	5 – 6	$\mathbf{E}_1^{p,q}(X) = H^q(X, \bar{\Omega}_X^p)$	20
$\mathcal{P}(A; x), \mathcal{P}(X; x)$	6	$H^s(X; \mathbb{C}), h^{p,q}(X)$	20 – 21
$\Omega_A^1, \Omega_A^p, \Omega_X^p, (\Omega_X^p)^\vee$	6	$H_{\text{prim}}^p(X; \mathbb{C}), h_{\text{prim}}^{p,q}(X)$	21
$\mathcal{O}_{X,x}, \text{Reg}(X), \text{Sing}(X)$	6	$W_\lambda(y_1, \dots, y_m), D_\lambda(y_1, \dots, y_k)$	22
$\mathcal{O}_X(D)$	6	$D_{\lambda,k}(y_1, \dots, y_k)$	22
$(D_1 \dots D_r)$	6	$\text{pt}(n; \mathbf{w})$	26
$\tilde{\Omega}_X^\bullet, \omega_X, \bar{\Omega}_X^\bullet$	6 – 7	$H^i(X, \mathcal{O}_X(n)), h^i(X, \mathcal{O}_X(n))$	26
$b_i(X), e(X)$	7	\bar{X}, X'	28
$h^i(X, \mathcal{F}), \chi(X, \mathcal{F})$	7	$\mathcal{V}(I)$	29
Pic(X)	7	$\eta_X, \mathbf{L}_X := \mathcal{O}_X(\eta_X)$	30
$\Delta(X, \mathbf{L})$	7	$\sigma, \dim(\sigma), \text{int}(\sigma), \partial\sigma, \check{\sigma}$	37
$[c_2]_Y, q_Y$	8	$s(n_1, \dots, n_\mu), T_N, U_\sigma$	37
β_Y	9	$\Sigma, \Sigma , \Sigma(i), Sk^1(\sigma)$	38
$\text{Amp}(X), \overline{\text{Amp}}(X), \overline{\text{NE}}(X)$	10	$Z(N, \Sigma)$	38

$\text{orb}(\sigma), V(\sigma) := \overline{\text{orb}(\sigma)}$	38	$\hat{f}_\rho, \varphi_\rho$	52
$\text{Star}(\tau)$	38	$F^\rho, \text{mil}(F^\rho), \mathfrak{h}_\rho$	52
$T_N \text{Div}(Z)$	39	$N_\rho(r_\rho), \Xi_\rho(r_\rho)$	53
$\Sigma_0, \sigma_0, N_G, M_G, T_G$	39	$T(r_\rho, s_\rho), V(r_\rho, s_\rho), \mathcal{L}^{(j)}$	53
$Z(N_G, \Sigma_0), Z(N_G, \Sigma'_0)$	39	$\mathfrak{Z}(r_\rho, s_\rho), \mathfrak{Y}_\rho(r_\rho, s_\rho), \mathfrak{e}(\rho)$	53
$(l; \alpha_1, \alpha_2, \dots, \alpha_r)$	39	$\mathfrak{G}_{r_j \lambda}^{(j \lambda)}$	53
$D_{n(\rho')}$	39	$X_I := X(I)$	55
$s_0 := s(e_1, e_2, e_3)$	40	$\Gamma'_0, \Gamma'_1, \hat{\Gamma}'_0$	59
Φ_G, D_n	40	\mathcal{B}_Y	71
$\Sigma'_0, \mathcal{S}, \Sigma'_0(\mathcal{S})$	40	$\mathcal{T}_D, \mathcal{T}_Y$	73
\mathbb{F}_a	41	$\varphi_{r_j}^{(j)}, \bar{\pi}_{r_j}^{(j)}$	74
$\mathcal{C}(n_1, n_2) := V(\sigma(s(n_1, n_2)))$	41	$\mathcal{S}_{P_i}, \tilde{\mathcal{S}}_{P_i}$	80
$\text{Spl}^1(\mathcal{S})(n)$	41	$N(\mathbf{w}), \Sigma(\mathbf{w}), N_0$	81
$b(n) := \sharp(\text{Spl}^1(\mathcal{S})(n))$	41	$\hat{\mathbb{P}}^{m-1}(\mathbf{w}), \hat{\Sigma}(\mathbf{w}), \hat{\pi} _Y$	82
$\tilde{\Sigma}, Z(N, \tilde{\Sigma})$	42	$\mathcal{M}_i, (\mathbf{n}_+^{(i)}, \mathbf{n}_-^{(i)}, \mathbf{n}_0^{(i)})$	87 – 89
$\Gamma_0, \hat{\Gamma}_0, \Gamma_1$	43	$\text{PT}(n; \mathbf{w}), \text{PT}^+(n; \mathbf{w})$	93
$\text{SSt}^0(X), \text{SSt}^1(X), \text{INP}(X)$	43	$\text{pt}^+(n; \mathbf{w})$	93
$C_j := X(I_j), \kappa$	43	$\mathbf{P}(n; \mathbf{w}), \Pi(\mathbf{w}), \mathbf{F}(x)$	93
$l_{C_j}, l_{P_i}, l_{Q_t}, \lambda, \mu$	44 – 45	$\tilde{\text{pt}}(n; \mathbf{w})$	94
$\pi_{P_i}(\mathcal{S}_{P_i}), \pi_{Q_t}(\mathcal{S}_{Q_t}), \pi_{C_j}$	47	$\mathbf{c}_{m-1-k}(n; \mathbf{w}), n', \Phi(n', \mathbf{w}), \Psi(n; \mathbf{w})$	94
$\mathcal{E}_{P_i}, \mathcal{E}_{Q_t}, \mathcal{E}_{C_j}, \mathcal{E}(X)$	47	$\mathbf{B}_1, \mathbf{B}_2, \dots$	97
$D_n^{(P_i)}, D_n^{(Q_t)}, D_{r_j}^{(C_j)}$	47	$\mathbf{G}_0, \mathbf{G}_1, \dots$	98
$a(P_i), a(Q_t)$	49	$R_1^{(i)}, R_2^{(i)}, \dots, \mathbf{R}_\nu$	99
$B_\epsilon(\mathbf{0}), \text{Lk}(\rho)$	52	$E(n; \mathbf{P}), E^+(n; \mathbf{P})$	101

$E_{\mathbf{P}}(x), E_{\mathbf{P}}^+(x)$	102
$\mathbf{a}_1(\mathbf{P}), \dots, \mathbf{a}_q(\mathbf{P})$	102
$\Sigma_{\mathbf{P}}, Z(N, \Sigma_{\mathbf{P}})$	102
F, σ_F	102
$\text{Td}(\dots)$	103
$\mathcal{F}_R, \mathcal{H}_R$	104
$N, N', G_{\sigma}, G_{\sigma}^0$	104
$\mathbf{P}'(\mathbf{w})$	104 – 105
$\tilde{\mathbf{P}}(w_1, \dots, w_{m-1})$	105
$\text{DS}(\mu, \nu)$	105 – 106
$((x))$	106
$\text{pt}(\mathbf{n}; A)$	106

Index of Terminology

- affine quasicone, 14
- ample cone, 10
- amplitude, 19
- Bernoulli numbers, 97
- Bertini quasismoothness criterion, 17
- Brieskorn-Pham c.i., 19
- BP-like c.i., 19
- canonical (or dualizing) sheaf, 6
- Cartier divisor, 6
- characteristic automorphism, 52
- Cohen-Macaulay ring, 5
- complete intersection (c.i.) in a w.p.s., 16
- c.i. of Fermat type, 19
- combinatorial Riemann-Roch theorem, 103
- compound Du Val locus, 15
- compound Du Val type points, 45
- CY model, 10
- CY threefold, 8
- cyclic quotient singularities (c.q.s.), 37
- Dedekind sum, 105
- delta genus, 7
- denumerant of weighted partitions, 93
- depth of a local ring, 5
- dissident points, 45
- dual cone, 37
- Ehrhart (quasi) polynomial, 102
- Ehrhart series, 102
- elementary transformation, 42
- face of a cone, 37
- fan, 38
- first skeleton of a cone, 38
- flop (simple flop), 48
- formulae
 - of Cappel and Shaneson, 104
 - of Csorba, 98
 - of Fergola and Sardi, 95
 - of Israilov, 100
 - of Sturmfels, 106
 - of Wehrauch and Ehrhart, 96
- generalized adjunction formula, 20
- Gorenstein ring, 5
- graded A -module, 5
- Hodge decomposition, 20
- Hodge numbers, 21
- individual points of $\text{Sing}(X)$, 45
- intersection number, 6
- isolated points of $\text{Sing}(X)$, 45
- local cohomology group, 5
- map of fans, 38
- minimal CY model, 10
- mirror phenomena, 3, 51
- money changing problem, 101
- Mori's cone, 10
- nef cone, 10
- nondegenerate q.s.c.i., 28
- normalized (system of) weights, 12
- overall well-stratified c.i., 51
- Picard group, 7
- Picard number, 8
- Poincaré series, 6
- polarized variety, 7
- prime divisor, 6
- primitive cohomology groups, 21
- punctured affine quasicone, 14
- pure Hodge structure, 20
- quasipolarized variety, 7
- quasipolynomial, 94
- quasismooth subvariety of a w.p.s., 15
- reciprocity relation/law, 94
- reduced (system of) weights, 12
- relative boundary, 37
- relative interior, 37
- relative link, 52
- relative Milnor fibers (fibration), 51 – 52
- relative Milnor number, 52
- regular local ring, 5
- regular sequence, 5
- simplicial cone, 37
- singular locus, 6
- strongly rational polyhedral cone, 37
- support of a fan, 38
- testing bilinear form, 9
- topological Yukawa coupling form, 8
- toric variety (associated to a fan), 38
- toroidal crepant desingularization, 49
- twisted module, 5
- type of a c.q.s., 39
- V -variety, 7
- waves, 95
- weighted projective space (w.p.s.), 12

Weil divisor, 6
well-formed w.p.s., 12
well-formed subvariety of a w.p.s., 16
well-stratified q.s.c.i., 29
w-reduction of a c.i. in a w.p.s., 28